

Attachment 15

Report to Congress: Impacts and Control of Combined Sewer Overflows and Sanitary Sewer Overflows (EPA, Aug. 2004)

Report to Congress on Impacts and Control of Combined Sewer Overflows and Sanitary Sewer Overflows

Fact Sheet

EPA has published a Report to Congress on the impacts and control of combined sewer overflows (CSOs) and sanitary sewer overflows (SSOs). This report was published to comply with a request from Congress. This report summarizes what is known about the characteristics of CSOs and SSOs, the human health and environmental impacts of CSOs and SSO, and the resources spent and technologies used by municipalities to reduce the impacts of CSOs and SSOs. This report makes clear that EPA views CSOs and SSOs as threats to human health and the environment. This Report provides interested parties with a wealth of information on the impacts of sewer overflows and establishes a baseline of data for regulatory agencies to use in policy making related to the management of sewer collection systems.

Why is EPA publishing this Report to Congress?

EPA prepared this Report to Congress in response to a statutory requirement established on December 15, 2000. Section 112 of the Consolidated Appropriations Act for Fiscal Year 2001, P.L. 106-554, required EPA to provide a report summarizing:

- (A) the extent of the human health and environmental impacts caused by municipal combined sewer overflows and sanitary sewer overflows, including the location of discharges causing such impacts, the volume of pollutants discharged, and the constituents discharged;
- (B) the resources spent by municipalities to address these impacts; and
- (C) an evaluation of the technologies used by municipalities to address these impacts.

What is a CSO?

A combined sewer system is a wastewater collection system, owned by a state or municipality, that is specifically designed to collect and convey sanitary wastewater (domestic sewage from homes as well as industrial and commercial wastewater) and storm water through a single pipe. During precipitation events (e.g. rainfall or snowmelt), the systems are designed to overflow when collection system capacity is exceeded, resulting in a combined sewer overflow (CSO) that discharges directly to surface waters.

Today, there are 746 communities with combined sewer systems with a total of 9,348 CSO outfalls that are identified and regulated by 828 NPDES permits. Combined sewer systems are found in 32 states (including the District of Columbia) and nine EPA Regions. CSO communities are regionally concentrated in older communities in the Northeast and Great Lakes regions. EPA estimates that about 850 billion gallons of untreated wastewater and storm water are released as CSO each year in the United States.

What is an SSO?

A sanitary sewer system is a wastewater collection system, owned by a state or municipality, that is specifically designed to collect and convey only sanitary wastewater (domestic sewage from homes as well as industrial and commercial wastewater). In such systems, storm water is conveyed through an additional set of pipes. These systems can overflow when collection system capacity is exceeded due to wet weather (as the result of infiltration and inflow), when normal dry weather flow is blocked for any of several reasons, or when mechanical failures prevent the system from proper operation.

In the Report to Congress, EPA estimates that between 23,000 and 75,000 SSOs occur each year in the United States, resulting in releases of between 3 billion and 10 billion gallons of untreated wastewater. These events take place throughout the United States.

What does the Report to Congress say?

This report includes 10 chapters covering all aspects of the statutory requirement from Congress. The report also includes a series of 23 technology descriptions providing detailed information, including case studies, on technologies for reducing the impacts of CSOs and SSOs.

This report finds that CSOs and SSOs can have impacts on human health and the environment at the local watershed level. The report makes clear that the United States has made progress in reducing sewer overflows to protect human health and the environment. Much remains to be done, however, to fully realize the objectives of the Clean Water Act and the CSO Control Policy

What impacts do CSOs and SSOs have?

Because CSOs contain raw sewage along with large volumes of storm water and contribute pathogens, solids, debris, and toxic pollutants to receiving waters, CSOs can create significant public health and water quality concerns. CSOs have contributed to beach closures, shellfish bed closures, contamination of drinking water supplies, and other environmental and public health concerns

Because SSOs contain raw sewage and can occur on land and in public spaces, SSOs can create public health and environmental concerns. SSOs have contributed to beach closures, contamination of drinking water supplies, and other environmental and public health concerns.

What recommendations does the Report to Congress make?

This report does not make specific policy recommendations, but does suggest four strategies that should be taken to reduce the impacts of CSOs and SSOs. The strategies include: providing adequate funding for maintenance and improvement of the nation's wastewater infrastructure; integrating of wastewater programs and activities at the watershed level; improving monitoring and reporting programs to provide better data for decision-makers; and supporting stronger partnerships among federal and state agencies, municipalities, industry, non-governmental organizations, and citizens.

How can I get more information?

You can find the Report to Congress and additional information on the Internet by visiting <http://www.epa.gov/npdes>. You can ask for hard copies of these documents by calling the Office of Water Resource Center at (202) 566-1729.



Report to Congress

Impacts and Control of CSOs and SSOs

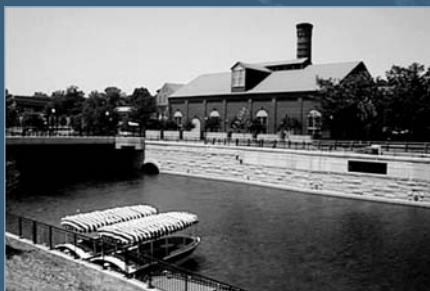

On the Cover

Large photo in background: Oklahoma City PVC sewer pipe stockpile. In response to problems from an aging sewer system made up of more than 2,000 miles of pipe, Oklahoma City implementing a capital improvement planning program with the goal of replacing sewer lines at the rate of 1% per year. The City opted for replacing aging pipes with PVC pipes as a more affordable, flexible and corrosion-resistant alternative. *Photo courtesy of Julia Moore, Limno-Tech, Inc..*

Top inset: Former Denny Way CSO outfall in Seattle, WA. The Denny Way outfall as shown was the largest volume CSO discharge in the King County System. Through a joint effort of King County and the City of Seattle, the Denny Way/Lake Union CSO Project was implemented to control over 600 million gallons of combined sewage from overflowing annually into Lake Union and Elliott Bay. Under way since May 2000, construction is expected to be complete in 2005. Progress to date includes the demolition of the pictured outfall, restoration of the shoreline, and revitalization of the surrounding public park. *Photo courtesy of King County.*

Second inset: Monitoring team responding to sewer overflow. *Photo provided by ADS.*

Third inset: City of Richmond, VA Canal Walk. The City of Richmond incorporated downtown revitalization, historical interpretation, and combined sewer overflow planning as part of a large-scale redevelopment of their downtown river front area. The riverfront redevelopment was made possible, in part, by the environmental improvements achieved by the Richmond CSO Control Program. The resulting Canal Walk extends for more than a mile along the Haxall and Kanawha Canals and includes under canal routing of combined sewage while providing a pathway of access to revitalized businesses, museums and new outdoor public vistas and arenas. *Photo courtesy of City of Richmond.*

Fourth inset: Orange County, CA. Orange County Health Care Agency's Environmental Health Ocean Water Protection Program administers a beach water quality monitoring program to ensure public recreational waters meet bacteriological water quality standards for full body contact recreational activities such as swimming, surfing and diving. Beach closure or advisory signs are posted at Orange County beaches when high levels of bacteria are measured or when a sewage spill contamination of ocean or bay waters occurs. *Photo courtesy of OCHCA EH Ocean Water Protection Program.*

Table of Contents

Executive Summary—Report to Congress on the Impacts and Control of CSOs and SSOs	ES-1
---	-------------

Chapter 1—Introduction	1-1
-------------------------------------	------------

1.1	What are CSOs and SSOs?	1-2
1.1.1	CSOs	1-2
1.1.2	SSOs	1-3
1.2	How is this Report Organized?	1-3

Chapter 2—Background	2-1
-----------------------------------	------------

2.1	What is the History of Sewer Systems in the United States?	2-1
2.1.1	Combined Sewers and CSOs	2-3
2.1.2	Sanitary Sewers and SSOs	2-4
2.2	What is the History of Federal Water Pollution Control Programs?	2-6
2.2.1	Secondary Treatment	2-6
2.2.2	Construction Grants	2-7
2.2.3	Pretreatment	2-8
2.2.4	Wet Weather	2-8
2.2.5	Watershed-Based Permitting	2-9
2.3	What is the Federal Framework for CSO Control?	2-9
2.3.1	CSO Case Law	2-9
2.3.2	The National CSO Control Strategy and the MAG	2-10
2.3.3	The CSO Control Policy	2-10
2.4	What is the Federal Framework for SSO Control?	2-10
2.5	What is the Wet Weather Water Quality Act?	2-11

Chapter 3—Methodology	3-1
------------------------------------	------------

3.1	What Study Objectives and Approach Did EPA Use to Prepare this Report?	3-1
3.2	What Data Sources Were Used?	3-2
3.2.1	Federal Data Sources	3-2
3.2.2	NPDES Authority and Other State Program Data Sources	3-3
3.2.3	Community-Level Data Sources	3-3
3.2.4	Non-Governmental Organization Data Sources	3-3
3.3	What Data Were Collected?	3-4
3.3.1	Characterization of CSOs and SSOs	3-4
3.3.2	Extent of Environmental Impacts Caused by CSOs and SSOs	3-5
3.3.3	Extent of Human Health Impacts Caused by CSOs and SSOs	3-6
3.3.4	Evaluation of Technologies Used by Municipalities to Address Impacts Caused by CSOs and SSOs	3-8

3.3.5 Assessment of Resources Spent by Municipalities to Address Impacts Caused by CSOs and SSOs 3-8

3.4 How Were Stakeholders Involved in the Preparation of this Report? 3-9

3.5 What Data Considerations Are Important? 3-10

3.6 What Quality Control and Quality Assurance Protocols Were Used? 3-11

3.7 Summary 3-12

Chapter 4—Characterization of CSOs and SSOs 4-1

4.1 What Pollutants are in CSOs and SSOs? 4-2

4.1.1 Microbial Pathogens 4-3

4.1.2 BOD₅ 4-4

4.1.3 TSS 4-5

4.1.4 Toxics 4-6

4.1.5 Nutrients 4-7

4.1.6 Floatables 4-7

4.2 What Factors Influence the Concentrations of the Pollutants in CSOs and SSOs? 4-8

4.2.1 Factors Influencing Pollutant Concentrations in CSOs 4-8

4.2.2 Factors Influencing Pollutant Concentrations in SSOs 4-9

4.3 What Other Point and Nonpoint Sources Might Discharge These Pollutants to Waterbodies Receiving CSOs and SSOs? 4-9

4.3.1 Wastewater Treatment Facilities 4-10

4.3.2 Decentralized Wastewater Treatment Systems 4-11

4.3.3 Industrial Point Sources 4-11

4.3.4 Urban Storm Water 4-12

4.3.5 Agriculture 4-12

4.3.6 Domestic Animals and Wildlife 4-12

4.3.7 Commercial and Recreational Vessels 4-13

4.4 What is the Universe of CSSs? 4-13

4.5 What are the Characteristics of CSOs? 4-16

4.5.1 Volume of CSOs 4-17

4.5.2 Frequency of CSOs 4-19

4.5.3 Location of CSOs 4-19

4.6 What is the Universe of SSSs? 4-20

4.7 What are the Characteristics of SSOs? 4-20

4.7.1 SSO Data Management System 4-20

4.7.2 Statistical Technique Used to Estimate Annual National SSO Frequency and Volume 4-23

4.7.3 Frequency of SSOs 4-24

4.7.4 Volume of SSOs 4-25

4.7.5 Location of SSOs 4-26

4.8 How Do the Volumes and Pollutant Loads from CSOs and SSOs Compare to Those from Other Municipal Point Sources? 4-29

Chapter 5—Environmental Impacts of CSOs and SSOs 5-1

5.1 What is EPA’s Framework for Evaluating Environmental Impacts? 5-1

5.2 What Overall Water Quality Impacts Have Been Attributed to CSO and SSO Discharges in National Assessments? . . 5-3

5.2.1 NWQI 2000 Report 5-3

5.2.2	Analysis of CSO Outfalls Discharging to Assessed or Impaired Waters	5-6
5.2.3	Modeled Assessment of SSO Impacts on Receiving Water Quality	5-8
5.3	What Impacts on Specific Designated Uses Have Been Attributed to CSO and SSO Discharges in National Assessments?	5-10
5.3.1	Recreation	5-10
5.3.2	Shellfish Harvesting	5-13
5.4	What Overall Water Quality Impacts Have Been Attributed to CSO and SSO Discharges in State and Local Assessments?	5-15
5.4.1	Water Quality Assessment in New Hampshire	5-15
5.4.2	Water Quality Assessment of the Mahoning River Near Youngstown, Ohio	5-15
5.4.3	Water Quality Assessment in Indianapolis, Indiana	5-16
5.4.4	Water Quality Risk Assessment of CSO Discharges in King County, Washington	5-16
5.5	What Impacts on Specific Designated Uses Have Been Attributed to CSO and SSO Discharges in State and Local Assessments?	5-17
5.5.1	Aquatic Life Support	5-18
5.5.2	Recreation	5-21
5.5.3	Shellfish Harvesting	5-25
5.6	What Factors Affect the Extent of Environmental Impacts Caused by CSOs and SSOs?	5-26
5.6.1	Timescale Considerations	5-28
5.6.2	Receiving Water Characteristics	5-28

Chapter 6—Human Health Impacts of CSOs and SSOs **6-1**

6.1	What Pollutants in CSOs and SSOs Can Cause Human Health Impacts?	6-1
6.1.1	Microbial Pathogens	6-2
6.1.2	Toxics	6-4
6.1.3	Biologically Active Chemicals	6-6
6.2	What Exposure Pathways and Reported Human Health Impacts are Associated with CSOs and SSOs?	6-7
6.2.1	Recreational Water	6-7
6.2.2	Drinking Water Supplies	6-10
6.2.3	Fish and Shellfish	6-12
6.2.4	Direct Contact with Land-Based Discharges	6-13
6.2.5	Occupational Exposures	6-14
6.2.6	Secondary Transmission	6-15
6.3	Which Demographic Groups Face the Greatest Risk of Exposure to CSOs and SSOs?	6-16
6.3.1	Swimmers, Bathers, and Waders	6-16
6.3.2	Subsistence and Recreational Fishers	6-16
6.3.3	Wastewater Workers	6-17
6.4	Which Populations Face the Greatest Risk of Illness from Exposure to the Pollutants Present in CSOs and SSOs?	6-17
6.4.1	Pregnant Women	6-17
6.4.2	Children	6-17
6.4.3	Immunocompromised Groups	6-18
6.4.4	Elderly	6-18
6.5	How are Human Health Impacts from CSOs and SSOs Communicated, Mitigated, and Prevented?	6-18
6.5.1	Agencies and Organizations Responsible for Protecting Public Health	6-18
6.5.2	Activities to Protect Public Health from Impacts of CSOs and SSOs	6-22
6.6	What Factors Contribute to Information Gaps in Identifying and Tracking Human Health Impacts from CSOs and SSOs?	6-24
6.6.1	Underreporting	6-24

6.6.2	Use of Indicator Bacteria	6-25
6.7	What New Assessment and Investigative Activities are Underway?	6-26
6.7.1	Investigative Activities	6-26

Chapter 7—Federal and State Efforts to Control CSOs and SSOs 7-1

7.1	What are States and EPA Regions Doing to Control CSOs?	7-1
7.1.1	Nine Minimum Controls	7-2
7.1.2	Long-Term Control Plans	7-2
7.2	What are States and EPA Regions Doing to Control SSOs?	7-3
7.2.1	Application of Standard Permit Conditions to SSOs	7-3
7.2.2	Electronic Tracking of SSOs	7-4
7.3	What Programs Have Been Developed to Control SSOs?	7-5
7.3.1	EPA Region 4’s MOM Program	7-5
7.3.2	Oklahoma - Collection System Program	7-6
7.3.3	California - Record Keeping and Reporting of Events	7-7
7.3.4	North Carolina - Collection System Permitting	7-8
7.4	What Compliance and Enforcement Activities Have Been Undertaken?	7-8
7.4.1	National Municipal Policy on POTWs	7-9
7.4.2	Enforcement Management System	7-9
7.4.3	Compliance and Enforcement Strategy (2000)	7-9
7.4.4	Compliance Assistance	7-10
7.4.5	Summary of Enforcement Activities	7-11

Chapter 8—Technologies Used to Reduce the Impacts of CSOs and SSOs 8-1

8.1	What Technologies are Commonly Used to Control CSOs and SSOs?	8-2
8.1.1	Operation and Maintenance Practices	8-2
8.1.2	Collection System Controls	8-5
8.1.3	Storage Facilities	8-11
8.1.4	Treatment Technologies	8-13
8.1.5	Low-Impact Development Techniques	8-17
8.2	How Do CSO and SSO Controls Differ?	8-20
8.2.1	Common CSO Control Measures	8-20
8.2.2	Common SSO Control Measures	8-21
8.3	What Technology Combinations are Effective?	8-21
8.3.1	Inflow Reduction or Low-Impact Development Coupled with Structural Controls	8-22
8.3.2	Disinfection Coupled with Solids Removal	8-22
8.3.3	Sewer Rehabilitation Coupled with Sewer Cleaning	8-22
8.3.4	Real-Time Control Coupled with In-line or Off-line Storage Facilities	8-22
8.4	What New Technologies for CSO and SSO Control are Emerging?	8-23
8.4.1	Optimization of Sewer System Maintenance	8-23
8.4.2	Information Management	8-23

Chapter 9—Resources Spent Address the Impacts of CSOs and SSOs 9-1

9.1	What Federal Framework Exists for Evaluating Resources Spent on CSO and SSO Control?	9-1
9.2	What are the Past Investments in Wastewater Infrastructure?	9-2

9.3	What Has Been Spent to Control CSOs?	9-5
9.4	What Has Been Spent to Control SSOs?	9-6
9.5	What Does it Cost to Maintain Sewer Systems?	9-7
9.6	What are the Projected Costs to Reduce CSOs?	9-8
9.7	What are the Projected Costs to Reduce SSOs?	9-9
9.8	What Funding Mechanisms are Available for CSO and SSO Control?	9-10
9.8.1	Self-financing	9-11
9.8.2	State and Federal Funding for CSO and SSO Control	9-12

Chapter 10—Conclusions and Future Challenges **10-1**

Protecting Infrastructure	10-2
Implementing the Watershed Approach	10-3
Improving Monitoring and Information-Based Environmental Management	10-4
Building Strategic Partnerships	10-5

List of Figures

Figure ES.1—National Distribution of CSSs	ES-5
Figure ES.2—National Distribution of SSSs	ES-6
Figure ES.3—Sources of Pollution that Resulted in Swimming Beach Advisories and Closings	ES-8
Figure 2.1—Typical Combined Sewer System	2-2
Figure 2.2—Typical Separate Sanitary and Storm Sewer Systems	2-2
Figure 2.3—National Distribution of Communities Served by CSSs	2-4
Figure 2.4—National Distribution of Communities Served by SSSs	2-5
Figure 4.1—Distribution of CSO Permits by Region and by State	4-14
Figure 4.2—Distribution of CSO Outfalls by Region and by State	4-15
Figure 4.3—Distribution POTW Facility Sizes Serving CSSs	4-17
Figure 4.4—Distribution of SSSs with Wastewater Treatment Facilities by Region and by State	4-21
Figure 4.5—Distribution of Satellite SSSs by Region and by State	4-22
Figure 4.6—States Providing Electronic Data on SSO Discharges	4-23
Figure 4.7—Total Number of SSO Events Reported by Individual Communities, January 1, 2001 - December 31, 2002 ...	4-25
Figure 4.8—Distribution of SSO Volume Reported Per Event	4-26
Figure 4.9—Most Common Reported Causes of SSO Events	4-27
Figure 4.10—Reported Causes of SSOs in Communities Reporting More than 100 SSO Events During a Single Calendar Year	4-28
Figure 4.11—Reported Cause of Blockage Events	4-28
Figure 5.1—NWQI 2000 Summary of Assessed Waters by Waterbody Type	5-4
Figure 5.2—Sources of Pollution that Resulted in Beach Advisories and Closings	5-11
Figure 5.3—Sources of Water Quality Impairment in New Hampshire	5-16
Figure 5.4—Fish Species Found in the Chicago and Calumet River System, 1974 - 2001	5-22
Figure 5.5—Sources of Contamination Resulting in California Beach Closures in 2000	5-22
Figure 5.6—Beach Closures in California During 2000 Attributed to SSOs	5-23
Figure 5.7—Average Number Days per Year Coastal Municipalities in Connecticut Closed One or More Beaches	5-24
Figure 5.8— Lake Michigan Beach Closures, 1998- 2002	5-25
Figure 5.9— Movement of Bacteria Plume from SSO Discharge in Raritan Bay, New Jersey	5-27
Figure 6.1—Microbial Pathogens Linked to Outbreaks in Recreational Waters, 1985 - 2000	6-8
Figure 6.2—Microbial Pathogens Causing Outbreaks Linked to Drinking Water, 1985-2000	6-11
Figure 9.1—Annual Capital Expenditures on Wastewater Projects, 1970 - 2000	9-3
Figure 9.2—State and Local Expenditures on Wastewater O&M, 1970 - 2000	9-4
Figure 9.3—CWSRF Annual Expenditures for CSO Projects, 1988 - 2002	9-5
Figure 9.4—CWSRF Annual Expenditures for I/I and Sewer Replacement/Rehabilitation	9-6
Figure 9.5—Changes in Estimated Needs Between 1996 and 2000 CWNS	9-10
Figure 9.6—Revenue Sources for Municipal Wastewater Treatment	9-11
Figure 9.7—State and Local Expenditures Under the CWSRF Program for CSO Correction and SSO Capital Projects ...	9-12

List of Tables

Table ES.1—Comparison of Estimated Annual Discharge Volumes	ES-7
Table 4.1—Fecal Coliform Concentrations in Municipal Discharges	4-3
Table 4.2—BOD ₅ Concentrations in Municipal Discharges	4-5
Table 4.3—TSS Concentrations in Municipal Discharges	4-5
Table 4.4—Cadmium and Copper Concentrations in Municipal Discharges	4-6
Table 4.5—Lead and Zinc Concentrations in Municipal Discharges	4-6
Table 4.6—Nutrient Concentrations in Municipal Discharges	4-6
Table 4.7—Volume Reduction Estimates Based on Implementation of CSO Control Policy	4-18
Table 4.8—SSO Event Volume by Cause	4-27
Table 4.9—Estimated Annual Municipal Point Source Discharges	4-29
Table 4.10—Estimated Annual BOD ₅ Load from Municipal Point Sources	4-29
Table 4.11—Estimated Annual TSS Load from Municipal Point Sources	4-30
Table 4.12—Estimated Annual Fecal Coliform Load from Municipal Point Sources	4-30
Table 5.1—Pollutants of Concern in CSOs and SSOs Likely to Cause or Contribute to Impairment	5-3
Table 5.2—Pollutants and Stressors Most Often Associated with Impairment	5-6
Table 5.3—Leading Sources of Pollutants and Stressors Causing Water Quality Impairment	5-6
Table 5.4—Occurrences of 305(b) Assessed Waters Within One Mile Downstream of a CSO Outfall	5-7
Table 5.5—Occurrence of 303(d) Listed Waters Within One Mile Downstream of a CSO Outfall	5-8
Table 5.6—Estimated Percentage of Time SSOs Would Cause Water Quality Standard Violations	5-9
Table 5.7—NMDMP Marine Debris Survey Results from 1996 to 2002	5-12
Table 5.8—Pollution Sources Reported for Harvest Limitations on Classified Shellfish Growing Waters in the 1990 and 1995 National Shellfish Registers	5-14
Table 5.9—Harvest Limitations on Classified Shellfish Growing Areas Within Five Miles of a CSO Outfall	5-15
Table 5.10—Relative Contributions of Pollutant Sources to Water Quality Problems in Indianapolis, Indiana	5-17
Table 5.11—Fish Kills Reported in North Carolina: 1997 - 2002	5-18
Table 5.12—Fish Kills Caused by Sewage Spills in North Carolina: 1997 - 2001	5-20
Table 5.13—Summary of Unauthorized Wastewater Discharges in Orange County, California, that Resulted in Beach Closures	5-25
Table 6.1—Common Pathogenic Bacteria Present in Sewage	6-3
Table 6.2—Common Enteric Viruses Present in Sewage	6-3
Table 6.3—Common Parasitic Protozoa Present in Sewage	6-4
Table 6.4—Concentration of Indicator Bacteria and Enteric Pathogens Shed by an Infected Individual	6-5
Table 6.5—Participation in Water-Based Recreation in U.S. during July 1999 and January 2001	6-7
Table 6.6—Estimated Number of Illnesses per Year Attributed to CSOs and SSOs	6-10
Table 6.7—Association of CSO Outfalls with Drinking Water Intakes	6-12
Table 6.8—Examples of Secondary Transmission from Waterborne and Non-Waterborne Disease Outbreaks	6-15

Table 7.1—Summary of Electronic SSO Data by State	7-4
Table 8.1—Summary of Operation and Maintenance Practices	8-3
Table 8.2—Summary of Collection System Controls	8-6
Table 8.3—Summary of Storage Facilities	8-12
Table 8.4—Summary of Treatment Technologies	8-15
Table 8.5—Summary of Low-Impact Development Techniques	8-18
Table 9.1—Annual Budget Expenditures in Sanitary Sewer Systems	9-7
Table 9.2—O&M Costs for Sewers	9-8

List of Appendices

Appendix A	Statutes, Policies, and Interpretative Memoranda
Appendix B	Human Health Expert and Stakeholder Meeting Summaries
Appendix C	Documentation of State and Municipal Interviews
Appendix D	List of Active CSO Permits
Appendix E	GPRACSO Model Documentation
Appendix F	Analysis of CSO Receiving Waters Using the National Hydrography Dataset (NHD)
Appendix G	National Estimate of SSO Frequency and Volume
Appendix H	Estimation of SSO Impacts in Streams and Rivers
Appendix I	Human Health Addendum
Appendix J	Estimated Annual Illness Burden Resulting from Exposure to CSOs and SSOs at BEACH Survey Beaches
Appendix K	Summary of Enforcement Actions
Appendix L	Technology Descriptions
Appendix M	Financial Information

List of Acronyms

AIDS– Acquired Immune Disorder Syndrome	CDC– Centers for Disease Control and Prevention	FWPCA– Federal Water Pollution Control Act
AMSA– Association of Metropolitan Sewerage Agencies	CFR– Code of Federal Regulations	GAO– Government Accounting Office
AO– Administrative Order	cfs– Cubic Feet per Second	GIS– Geographic Information System
APO– Administrative Penalty Orders	CIPP– Cured-in-place Pipe	GPRA– Government Performance and Results Act
APWA– American Public Works Association	CMOM– Capacity, Management, Operation, and Maintenance	HUD– Housing of Urban Development
ASCE– American Society of Civil Engineers	CSO– Combined Sewer Overflow	I/I– Infiltration & Inflow
BAT– Best Available Technology Economically Achievable	CSS– Combined Sewer System	ISSC– Interstate Shellfish Sanitation Conference
BCT– Best Conventional Pollutant Control Technology	CTP– Central Treatment Plant	LGEAN– Local Government Environmental Assistance Network
BEACH Program– Beaches Environmental Assessment and Coastal Health Program	CWNS– Clean Watersheds Needs Survey	LID– Low Impact Development
BMP– Best Management Practice	CWSRF– Clean Water State Revolving Fund	LOV– Letter of Violation
BOD ₅ – Biochemical Oxygen Demand (measured over 5 days)	ECD– Enforcement and Compliance Docket	LTCP– Long-Term Control Plan
CAFO– Concentrated Animal Feeding Operation	ENR– <i>Engineering News Record</i>	MAG– Office of Water Management Advisory Group
CATAD– Computer Augmented Treatment and Disposal	EPA– Environmental Protection Agency	MDE– Maryland Department of the Environment
CBO– Congressional Budget Office	FEB– Flow Equalization Basins	MDEQ– Michigan Department of Environmental Quality
CCTV– Closed Circuit Television	FAC– Federal Advisory Committee	MG– Million Gallons
	FOG– Fats, Oils, and Grease	mgd– Million Gallons per Day
	FR– <i>Federal Register</i>	ml– Milliliter
	FY– Fiscal Year	

MMSD– Milwaukee Metropolitan Sewerage District	NWQI– National Water Quality Inventory	WDR– Waste Discharge Requirements
MOM– Management, Operation, and Maintenance	O&M– Operation and Maintenance	WEF– Water Environment Federation
MPN– Most Probable Number	ODEQ– Oklahoma Department of Environmental Quality	WERF– Water Environment Research Foundation
MWWSSB– Montgomery Water Works and Sanitary Sewer Board	OMB– Office of Management and Budget	WISE– Watershed Initiative for a Safe Environment
MS4– Municipal Separate Storm Sewer System	ORD– Office of Research and Development	WWTP– Wastewater Treatment Plant
NCDENR– North Carolina Department of Environmental and Natural Resources	PCBs– Polychlorinated biphenyls	
NEEAR Water Study– National Epidemiological and Environmental Assessment of Recreational Water Study	PCS– Permit Compliance System	
NIH– National Institutes of Health	P.L.– Public Law	
NHD– National Hydrography Dataset	POTW– Publicly Owned Treatment Works	
NJDEP– New Jersey Department of Environmental Protection	REAP– Rural Economic Assistance Program	
NMC– Nine Minimum Controls	RWQCB– Regional Water Quality Control Board	
NMDSP– National Marine Debris Survey Program	SRF– State Revolving Fund	
NMP–National Municipal Policy	SSO– Sanitary Sewer Overflow	
NOAA–National Oceanic and Atmospheric Administration	SSS– Sanitary Sewer System	
NPDES– National Pollutant Discharge Elimination System	TKN– Total Kjeldahl Nitrogen	
NRDC– Natural Resources Defense Council	TMDL– Total Maximum Daily Loads	
NURP– Nationwide Urban Runoff Program	TSS– Total Suspended Solids	
	USGS– United States Geological Survey	
	UV– Ultraviolet	
	WATERS- Watershed Assessment, Tracking, & Environmental ResultS	

Glossary

This glossary includes a collection of the terms used in this manual and an explanation of each term. To the extent that definitions and explanations provided in this glossary differ from those in EPA regulations or other official documents, they are intended for use in understanding this manual only.

A

Acute Toxicity– The ability of a substance to cause severe biological harm or death soon after a single exposure or dose. Also, any poisonous effect resulting from a single short-term exposure to a toxic substance.

B

Bacteria– Microscopic, unicellular organisms, some of which are pathogenic and can cause infection and disease in animals and humans. Most often, non-pathogenic bacteria, such as fecal coliform and enterococci, are used to indicate the likely presence of disease-causing, fecal-borne microbial pathogens.

Best Available Technology Economically Achievable (BAT)– Technology-based standard established by the Clean Water Act as the most appropriate means

available on a national basis for controlling the direct discharge of toxic and nonconventional pollutants to navigable waters.

Best Conventional Pollutant Control Technology (BCT)– Technology-based standard for the discharge from existing industrial point sources of conventional pollutants including BOD, TSS, fecal coliform, pH, oil and grease. The BCT is established in light of a two-part “cost reasonableness” test, which compares the cost for an industry to reduce its pollutant discharge with the cost to a POTW for similar levels of reduction of a pollutant loading. The second test examines the cost-effectiveness of additional industrial treatment beyond BPT. EPA must find limits, which are reasonable under both tests before establishing them as BCT.

Biochemical Oxygen Demand (BOD)– A measure of the amount of oxygen consumed by microorganisms from the decomposition of organic

material in water over a specified time period (usually 5 days, indicated as BOD₅). The BOD₅ value is used for many applications, most commonly to indicate the effects of sewage and other organic wastes on dissolved oxygen in water.

C

Chronic Toxicity– The capacity of a substance to cause long-term poisonous health effects in humans, animals, fish, and other organisms.

Clean Water Act– The Clean Water Act is an act passed by the U.S. Congress to control water pollution. It was formerly referred to as the Federal Water Pollution Control Act of 1972 or Federal Water Pollution Control Act Amendments of 1972 (P.L. 92-500), 33 U.S.C. 1251 et. seq., as amended by: P.L. 96-483; P.L. 97-117; P.L. 95-217, 97-117, 97-440, and 100-04.

Combined Sewer Overflow (CSO)— A discharge of untreated wastewater from a combined sewer system at a point prior to the headworks of a publicly owned treatment works (POTW).

Combined Sewer System (CSS)— A wastewater collection system owned by a municipality (as defined by Section 502(4) of the Clean Water Act) that conveys domestic, commercial and industrial wastewater and storm water runoff through a single pipe system to a POTW.

Concentrated Animal Feeding Operation (CAFO)— New and existing animal feeding operations of a sufficient size that are required to develop and implement a nutrient management plan as a condition of a NPDES permit (defined at 40 CFR 122.23).

Construction Grants Program— Federal assistance program authorized under Section 201 of the Clean Water Act intended to assist with the development and implementation of waste treatment management plans and practices that will achieve the goals of the Act.

Conventional Pollutants— As defined by the Clean Water Act, conventional pollutants include: BOD, TSS, fecal coliform, pH, and oil and grease.

D

Dissolved Oxygen (DO)— The oxygen freely available in water, vital to fish and other aquatic life and for the prevention of odors. DO levels are considered a most important indicator of a water body's ability to support desirable aquatic life. Secondary and advanced waste treatment are generally designed to ensure adequate DO in waste-receiving waters.

Diurnal— Relating to or occurring in a 24-hour period, or daily. A pattern that repeats itself over a daily cycle.

Dry Weather CSO— An unauthorized discharge from a combined sewer system that occurs during dry weather conditions.

Dry Weather SSO— A sanitary sewer overflow that occurs during dry weather conditions, most often as a result of blockages, line breaks, or mechanical/power failures in the collection system.

E

Effluent Limits— Restrictions established by a state or EPA on quantities, rates, and concentrations in municipal or industrial wastewater discharges.

Environmental Impact— Any change to the environment, whether adverse or beneficial, wholly or partially resulting from an

organization's activities, products or services.

Eutrophic Condition— The presence of excess nutrients in a receiving water body. During the later stages of eutrophication the water body can become choked by abundant plant life due to higher levels of nutritive compounds such as nitrogen and phosphorus.

F

Federal Advisory Committee— Any committee, board, commission, council, conference, panel, task force, or other similar group, or any subcommittee or other sub-group thereof (hereafter in this paragraph referred to as "committee"), which in— (A) established by statute or organization plan, or (B) established or utilized by the President; or (C) established or utilized by one or more agencies; in the interest of obtaining advise and recommendations for the President or one or more agencies or offices of the Federal Government, except that such term excludes (i) any committee that is composed wholly of full-time, or permanent part-time, officers or employees of the Federal Government, and (ii) any committee that is created by the National Academy of Sciences of the National Academy of Public Administration.

First Flush— The occurrence of higher concentrations of pollutants in

storm water or CSO discharges at the beginning of a storm.

Floatables and Trash– Visible buoyant or semi-buoyant solids including organic matter, personal hygiene items, plastics, styrofoam, paper, rubber, glass and wood.

H

Headworks of a Wastewater Treatment Plant– The initial structures, devices and processes provided at a wastewater treatment plant including screening, pumping, measuring, and grit removal facilities.

Human Health Impacts– Damage to the health of an individual or individuals due to a given exposure or a series of exposures.

I

Indicator Bacteria– Bacteria that are common in human waste. Indicator bacteria are not harmful in themselves but their presence is used to indicate the likely presence of disease-causing, fecal-borne microbial pathogens that are more difficult to detect.

Infiltration– Storm water and groundwater that enter a sewer system through such means as defective pipes, pipe joints, connections, or manholes. (Infiltration does not include inflow).

Infiltration/Inflow (I/I)– The total quantity of water from both infiltration and inflow.

Inflow– Water, other than wastewater, that enters a sewer system from sources such as roof leaders, cellar drains, yard drains, area drains, foundation drains, drains from springs and swampy areas, manhole covers, cross connections between storm drains and sanitary sewers, catch basins, cooling towers, storm waters, surface runoff, street wash waters, or other drainage. (Inflow does not include infiltration).

L

Long-Term Control Plan (LTCP)– Water quality-based CSO control plan that is ultimately intended to result in compliance with the Clean Water Act. Long-term control plans should consider the site-specific nature of CSOs and evaluate the cost effectiveness of a range of controls.

M

Major Facility– Classification for wastewater treatment plants that are designed to discharge more than 1 mgd. Some facilities with smaller design flows are classified as major facilities when the NPDES authority deems it necessary for a specific NPDES permit to have a stronger regulatory focus.

Microbial Pathogens– Minute life forms including bacteria, viruses and parasites that can cause disease in aquatic biota and illness or even death in humans.

Million Gallons per Day (mgd)– A unit of flow commonly used for wastewater discharges. One mgd is equivalent to a flow rate of 1.547 cubic feet per second over a 24-hour period.

Minor Facility– A classification for wastewater treatment plants that are designed to discharge less than 1 mgd.

N

National Pollutant Discharge Elimination System (NPDES)– The national program for issuing, modifying, revoking and reissuing, terminating, monitoring and enforcing permits, and imposing and enforcing pretreatment requirements, under Sections 307, 318, 402, and 405 of the Clean Water Act.

Nine Minimum Controls (NMC)– Technology-based CSO controls that do not require significant engineering studies or major construction.

Nutrient– Any substance assimilated by living things that promotes growth. The term is generally applied to nitrogen and phosphorus in wastewater, but is also applied to other essential and trace elements.

O

Oxygen Depleting Substances–

Materials including human waste and other organic matter that cause a loss of oxygen in water and wastewater, typically measured in terms of BOD₅.

P

Parasites– Animals or plants that live in and obtain nutrients from a host organism of another species.

Pathogenic– Capable of causing disease.

Point Source– Any discernible, confined, and discrete conveyance, including but not limited to any pipe, ditch, channel, tunnel, conduit, well, discrete fixture, container, rolling stock, concentrated animal feeding operation, landfill leachate collection system, vessel, or other floating craft from which pollutants are or may be discharged.

Primary Treatment– First steps in wastewater treatment wherein screens and sedimentation tanks are used to remove most materials that float or will settle.

Publicly Owned Treatment Works (POTW)– A treatment works, as defined by Section 212 of the Clean Water Act that is owned by a state or municipality. This definition includes any devices and systems used in the storage,

treatment, recycling, and reclamation of municipal sewage or industrial wastes of a liquid nature. It also includes sewers, pipes, and other conveyances only if they convey wastewater to a POTW treatment plant [40 CFR §403.3].

Q

Sanitary Sewer Overflow (SSO)– An untreated or partially treated sewage release from a sanitary sewer system.

Sanitary Sewer System (SSS)– A municipal wastewater collection system that conveys domestic, commercial and industrial wastewater, and limited amounts of infiltrated ground water and storm water, to a POTW. Areas served by sanitary sewer systems often have a municipal separate storm sewer system to collect and convey runoff from rainfall and snowmelt.

Satellite Sewer Systems– Combined or separate sewer systems that convey flow to a publicly owned treatment works owned and operated by a separate entity.

Secondary Treatment– Technology-based requirements for direct discharging municipal sewage treatment facilities. Standard is based on a combination of physical and biological processes for the treatment of pollutants in municipal sewage. Standards are expressed as a minimum

level of effluent quality in terms of: BOD₅, suspended solids, and pH (except as provided for special considerations and treatment equivalent to secondary treatment).

State Revolving Fund Program– A federal program created by the Clean Water Act Amendments in 1987 that offers low interest loans for wastewater treatment projects.

T

Technology-Based Effluent Limit– Effluent limitations applicable to direct and indirect sources, which are developed on a category-by-category basis using statutory factors, not including water quality effects.

Total Suspended Solids (TSS)– A measure of the filterable solids present in a sample of water or wastewater (as determined by the method specified in 40 CFR Part 136).

Toxics– Materials contaminating the environment that cause death, disease, and/or birth defects in organisms that ingest or absorb them. The quantities and length of exposure necessary to cause these effects can vary widely.

W

Water Quality Standard– A law or regulation that consists of the beneficial use or uses of a waterbody, the numeric and

narrative water quality criteria that are necessary to protect the use or uses of that particular waterbody, and an antidegradation statement.

Water Quality-Based Effluent

Limitations– Effluent limitations applied to dischargers when technology-based limitations insufficient to result in the attainment of water quality standards. Usually applied to discharges into small streams.

Waters of the United States– All waters that are currently used, were used in the past, or may be susceptible to use in interstate or foreign commerce, including all waters subject to the ebb and flow of the tide. Waters of the United States include but are not limited to all interstate waters and intrastate lakes, rivers, streams (including intermittent streams), mudflats, sand flats, wetlands, sloughs, prairie potholes, wet meadows, play lakes, or natural ponds. [See 40 CFR §122.2 for the complete definition.]

Watershed Approach– An initiative that promotes integrated solutions to address surface water, groundwater, and habitat concerns on a watershed basis. It is a decision-making process that reflects a common strategy for information collection and analysis and a common understanding of the roles, priorities and responsibilities of all stakeholders within a watershed.

Wet Weather Event– A discharge from a combined or sanitary

sewer system that occurs in direct response to rainfall or snowmelt.

Wet Weather SSO– A sanitary sewer overflow that results from the introduction of excessive inflow and infiltration into a sanitary sewer system, such that the total flow exceeds conveyance capacity.

Executive Summary

Report to Congress on the Impacts and Control of CSOs and SSOs

The U.S. Environmental Protection Agency (EPA or “the Agency”) is transmitting this Report to Congress on the extent of human health and environmental impacts caused by municipal combined sewer overflows (CSOs) and sanitary sewer overflows (SSOs), including the location of discharges causing such impacts, the volume of pollutants discharged, the constituents discharged, the resources spent by municipalities to address these impacts, and the technologies used by municipalities to address these impacts.

Overview and Background

Why is EPA Preparing this Report?

In the Consolidated Appropriations Act for Fiscal Year 2001, P.L. 106-554 (or “2000 amendments to the Clean Water Act”), Congress requested two reports and the development of a technology clearinghouse. The first report was transmitted to Congress in December 2001 as *Report to Congress—Implementation and Enforcement*

of the Combined Sewer Overflow Control Policy (EPA 2001a). This second Report to Congress fulfills the requirement that:

Not later than 3 years after the date of enactment of this Act, the Administrator of the Environmental Protection Agency shall transmit to Congress a report summarizing—

(A) the extent of human health and environmental impacts caused by municipal combined sewer overflows and sanitary sewer overflows, including the location of discharges causing such impacts, the volume of pollutants discharged, and the constituents discharged;

(B) the resources spent by municipalities to address these impacts; and

(C) an evaluation of the technologies used by municipalities to address these impacts.

Further, the technology information compiled for this Report to Congress will serve as a key element in developing the technology



SSOs include untreated discharges from SSSs that reach waters of the United States, as well as overflows out of manholes and onto city streets, sidewalks, and other terrestrial locations.

Photo: EPA

clearinghouse requested by P.L. 106-554.

What are CSOs and Why are They a Problem?

Two types of public sewer systems predominate in the United States: combined sewer systems (CSSs) and sanitary sewer systems (SSSs). CSSs were among the earliest sewer systems constructed in the United States and were built until the first part of the 20th century. As defined in the 1994 CSO Control Policy (EPA 1994a), a CSS is:

A wastewater collection system owned by a state or municipality (as defined by Section 502(4) of the Clean Water Act) that conveys domestic, commercial, and industrial wastewaters and storm water runoff through a single pipe system to a publicly-owned treatment works (POTW).

During wet weather events (e.g., rainfall or snowmelt), the combined volume of wastewater and storm water runoff entering CSSs often exceeds conveyance capacity. Most CSSs are designed to discharge flows that exceed conveyance capacity directly to surface waters, such as rivers, streams, estuaries, and coastal waters. Such events are called CSOs.

A CSO is defined as:

The discharge from a CSS at a point prior to the POTW treatment plant.

Some CSO outfalls discharge infrequently, while others discharge every time it rains. Overflow frequency and duration varies from system to system and from outfall to

outfall within a single CSS. Because CSOs contain untreated wastewater and storm water, they contribute microbial pathogens and other pollutants to surface waters. CSOs can impact the environment and human health. Specifically, CSOs can cause or contribute to water quality impairments, beach closures, shellfish bed closures, contamination of drinking water supplies, and other environmental and human health problems.

What are SSOs and Why are They a Problem?

Since the first part of the 20th century, municipalities in the United States have generally constructed SSSs. For the purposes of this Report to Congress, an SSS is:

A municipal wastewater collection system that conveys domestic, commercial, and industrial wastewater, and limited amounts of infiltrated groundwater and storm water, to a POTW.

SSSs are not designed to collect large amounts of storm water runoff from precipitation events. Areas served by SSSs often have a municipal separate storm sewer system (MS4) to collect and convey runoff from rainfall and snowmelt.

Untreated or partially treated discharges from SSSs are commonly referred to as SSOs. SSOs have a variety of causes including blockages, line breaks, sewer defects that allow excess storm water and groundwater to overload the system, lapses in sewer system operation and maintenance, inadequate sewer design and

construction, power failures, and vandalism. An SSO is defined as:

An untreated or partially treated sewage release from a SSS.

The discussion of SSOs in this report, including national estimates of SSO volume and frequency, does not account for discharges from points after the headworks of the treatment plant, regardless of the level of treatment, or backups into buildings caused by problems in the publicly-owned portion of the SSS. EPA found that backups into buildings are not widely tracked by permitting authorities.

Generally speaking, SSOs can occur at any point in an SSS, during dry weather or wet weather. SSOs include overflows that reach waters of the United States. SSOs also include overflows out of manholes and onto city streets, sidewalks, and other terrestrial locations. A limited number of municipalities have SSOs that discharge from fixed points within their sewer system. SSSs can back up into buildings, including private residences. When sewage backups are caused by problems in the publicly-owned portion of an SSS, they are considered SSOs.

SSOs can range in volume from one gallon to millions of gallons. The microbial pathogens and other pollutants present in SSOs can cause or contribute to water quality impairments, beach closures, shellfish bed closures, contamination of drinking water supplies, and other environmental and human health problems.

What Statutory and Regulatory Framework Applies to CSOs and SSOs?

With extensive and documented stakeholder support, EPA issued its final CSO Control Policy on April 19, 1994 (59 FR 18688). The CSO Control Policy “represents a comprehensive national strategy to ensure that municipalities, permitting authorities, water quality standards authorities, and the public engage in a comprehensive and coordinated effort to achieve cost-effective CSO controls that ultimately meet appropriate health and environmental objectives.”

When the CSO Control Policy was released, many stakeholders, key members of Congress, and EPA advocated for it to be endorsed in the Clean Water Act to ensure its full implementation. In the Consolidated Appropriations Act for Fiscal Year 2001, P.L. 106-554, Congress stated that:

...each permit, order, or decree issued pursuant to this Act after the date of enactment of this subsection for a discharge from a municipal combined storm and sanitary sewer shall conform to the CSO Control Policy signed by the Administrator on April 11, 1994.

SSOs that reach waters of the United States are point source discharges, and, like other point source discharges from municipal SSSs, are prohibited unless authorized by an National Pollutant Discharge Elimination System (NPDES) permit. Moreover, SSOs, including those that do not reach waters of the United States, may be indicative of improper operation and maintenance of the sewer system,



CSO outfalls were constructed in a wide variety of shapes and sizes, including the large box culvert shown here. In general, CSO outfalls discharge directly to receiving waters.

Photo: City of Wilmington, DE

and thus may violate NPDES permit conditions.

What Methodology Did EPA Use for this Report to Congress?

The basic study approach for this report was to divide the congressional request into a series of discrete study questions, then to identify and collect existing data appropriate to each study question. This effort entailed:

- Reviewing existing data collected by EPA and other federal agencies, state and local governments, and non-governmental organizations;
- Searching the existing literature for environmental and human health impacts attributable to CSOs and SSOs, as well as the cost and technologies used to control CSOs and SSOs;
- Organizing forums to work with EPA and external experts and stakeholders on the specific questions addressed in this report;
- Updating, verifying, and establishing latitude and longitude coordinates for the inventory of CSO outfalls developed as part of EPA's 2001 *Report to Congress—Implementation and Enforcement of the Combined Sewer Overflow Control Policy*;
- Collecting SSO event information from those states that compile data on the volume, frequency, and cause of SSO events in electronic data management systems;
- Developing national estimates of the volume and frequency of CSOs and SSOs; and

- Developing simple models to estimate environmental and human health impacts where there was an absence of direct cause-and-effect data.

EPA emphasized the collection, compilation, and analysis of existing data for this report. This effort allowed the Agency to expand its knowledge about CSOs and SSOs, and to identify gaps in the existing data and in current systems that provide such data. This Report to Congress recognizes that EPA should and will continue to investigate the environmental and human health challenges posed by wet weather.

Response to Congress

EPA's response to the congressional request set forth in P.L. 106-554 is presented below, organized into five themes addressing both CSOs and SSOs:

- Characterization
- Environmental impacts
- Human health impacts
- Control technologies
- Resources spent

What are the Location, Volume of Pollutants, and Constituents of CSOs and SSOs?

Currently, 828 NPDES permits authorize discharges from 9,348 CSO outfalls in 32 states (including the District of Columbia). As shown in Figure ES.1, most CSSs are located in the Northeast and Great Lakes regions.

The estimated volume of CSO discharged nationwide is 850 billion gallons per year. The number of CSSs and CSO permits has decreased slightly since publication of EPA’s 2001 *Report to Congress—Implementation and Enforcement of the Combined Sewer Overflow Control Policy*. Further, the percentage of CSO long-term control plans (LTCPs) that have been submitted to permitting authorities has increased from 34 to 59 percent. This represents progress in controlling CSOs in the United States.

As shown in Figure ES.2, SSSs are located across the country. EPA’s 2000 *Clean Watersheds Needs Survey (CWNS) Report to Congress* reported 15,582 municipal SSSs with wastewater treatment facilities; an additional

4,846 satellite SSSs collect and transport wastewater flows to regional wastewater treatment facilities. SSOs have the potential to occur in any of these SSSs.

EPA estimates that between 23,000 and 75,000 SSO events occur per year in the United States, discharging a total volume of three to 10 billion gallons per year. This estimate does not account for discharges occurring after the headworks of the treatment plant or backups into buildings caused by problems in the publicly-owned portion of an SSS. The majority of SSO events are caused by sewer blockages that can occur at any time. The majority of SSO volume appears to be related to events caused by wet weather and excessive inflow and infiltration.

Figure ES.1

National Distribution of CSSs

The majority of CSO permits are held by communities located in the Northeast and Great Lakes regions.

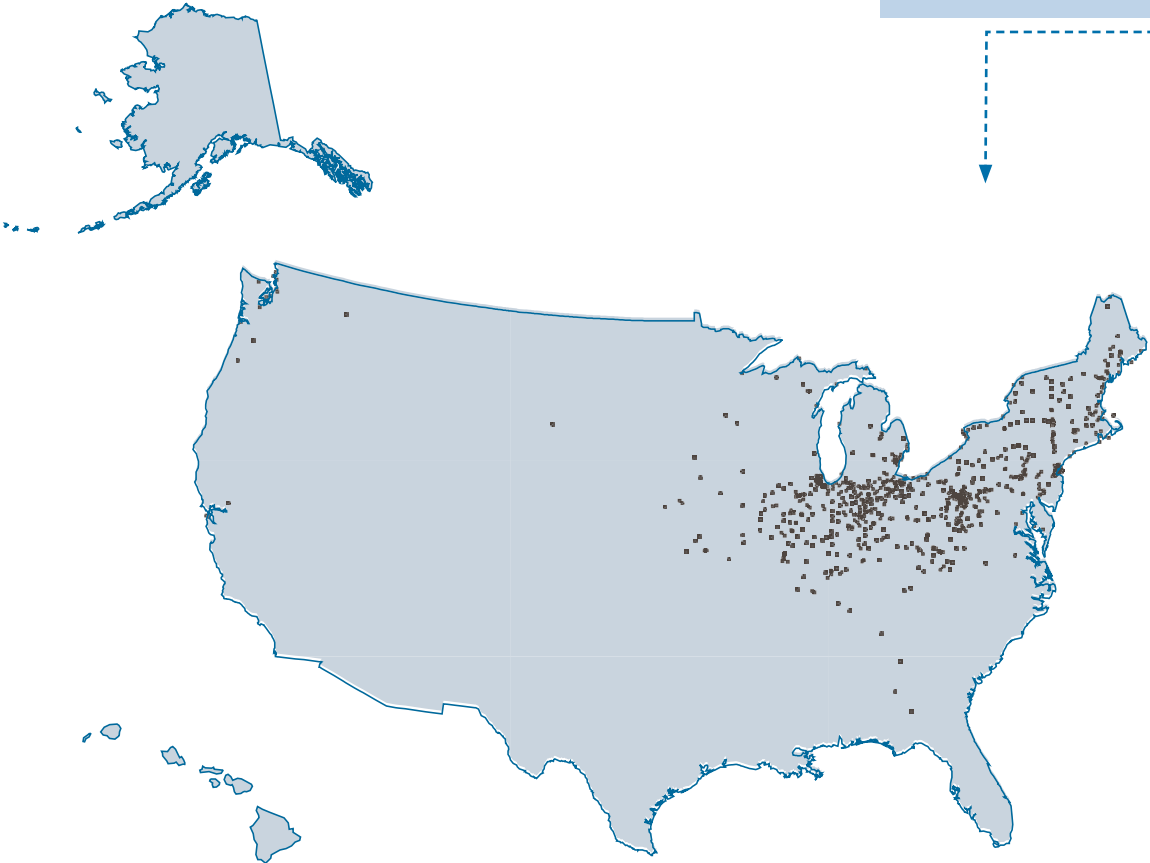

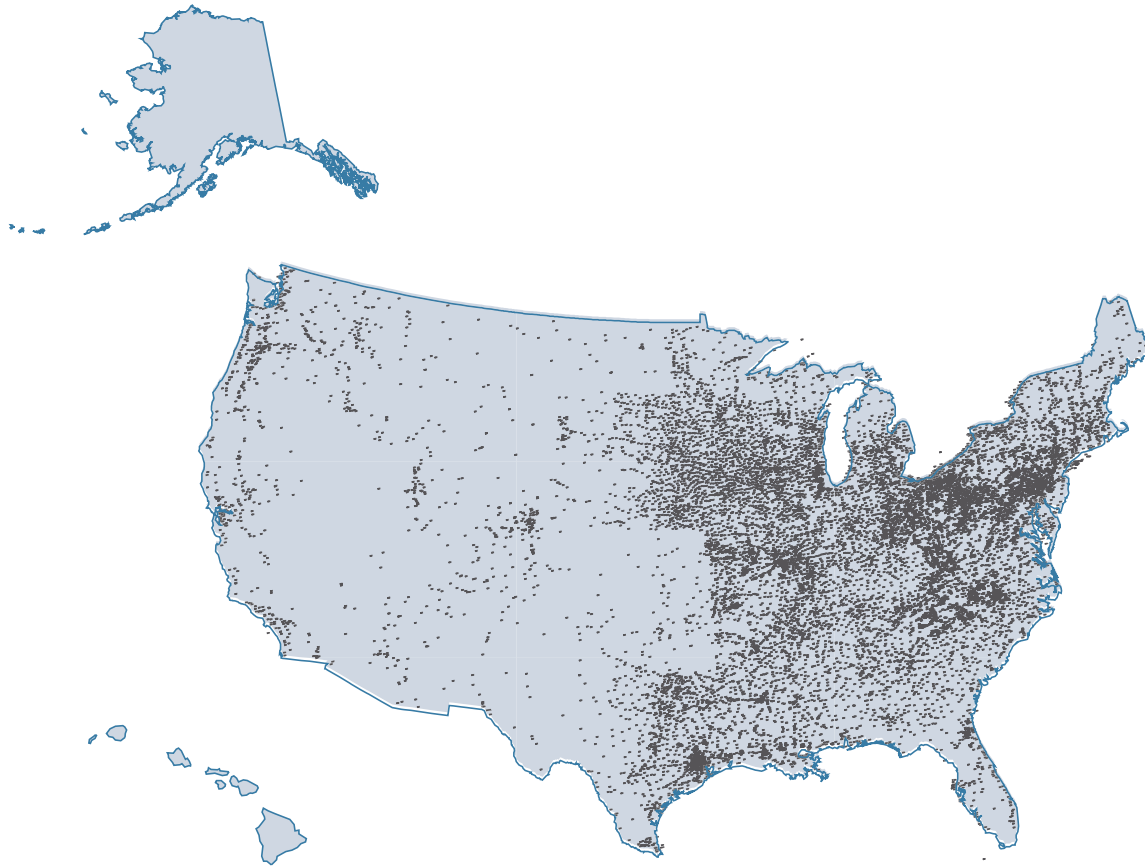

Figure ES.2

National Distribution of SSSs

SSSs are widely distributed across the United States, serving municipalities in all 50 states. Approximately 75 percent of SSSs are shown, where location data (latitude/longitude) were available from EPA's Permits Compliance System.

A comparison of the estimated annual CSO and SSO discharge volume with treated wastewater is presented in Table ES.1.

CSOs and SSOs contain untreated wastewater, and therefore the pollutant concentration depends on the service population, the characteristics of the sewer system, weather conditions, any treatment provided, and other factors. The principal pollutants present in CSOs and SSOs are:

- Microbial pathogens
- Oxygen depleting substances

- Total suspended solids (TSS)
- Toxics
- Nutrients
- Floatables and trash

Pollutant concentrations in CSOs and SSOs vary substantially, not only from community to community and event to event, but also within a given event. CSOs and SSOs contribute pollutant loadings to waterbodies where discharges occur. It is important to note that waterbodies also receive pollutants of the types found in CSOs and SSOs from other sources such as storm water runoff.

Source	Annual Discharge Volume (billion gallons)
Treated wastewater ^a	11,425
CSO ^b	850
SSO ^c	3 - 10

^a EPA 2000a

^b GPRACSO model, Section 4.5.1 of this report

^c Section 4.7.4 of this report

Table ES.1

Estimated Annual Discharge Volumes

On an annual basis, the volume of CSO and SSO discharged is a proportionally small amount compared to the total flow processed at municipal treatment facilities.

What is the Extent of Environmental Impacts Caused by CSOs and SSOs?

Pollutant concentrations in CSOs and SSOs may be sufficient to cause a violation of water quality standards, precluding the attainment of one or more of the designated uses (e.g., swimming, boating, fishing) for the waterbody.

CSOs and wet weather SSOs discharge simultaneously with storm water runoff and other nonpoint sources of pollution. EPA recognizes that this can make it difficult to identify and assign specific cause-and-effect relationships between CSOs, SSOs, and observed water quality problems. In addition, EPA found that the identification and quantification of environmental impacts caused by CSOs and SSOs at the national level is difficult because there is no comprehensive national data system for tracking the occurrence and impacts of CSOs and SSOs.

Nevertheless, CSOs and SSOs can by themselves affect the attainment of designated uses and cause water quality standards violations. Average bacteria concentrations in CSOs and SSOs may be several thousand times greater than water quality standard criteria, and waterbodies that receive

CSO and SSO discharges may lack sufficient dilution or assimilative capacity. Based on modeling analysis conducted by EPA and summarized in Table 5.6 of this report, water quality standards are projected to be violated frequently, even in the absence of other sources of fecal coliform pollution, where discharges from SSO events include more concentrated wastewater (e.g., SSOs with limited I/I) or when SSOs discharge to smaller receiving waters such as a stream or small tributary.

As shown in Figure ES.3, CSOs were responsible for 1 percent of reported advisories and closings, and 2 percent of advisories and closings that had a known cause during the 2002 swimming season. SSOs were reported to be responsible for 6 percent of reported advisories and closings, and 12 percent of advisories and closings having a known cause. Studies also identify CSOs and SSOs as a cause of shellfish harvesting prohibitions and restrictions in classified shellfish growing areas.

The environmental impacts of CSOs and SSOs are most apparent at the local level, and as the result of large or recurrent discharges. Examples of localized impacts due to CSOs and SSOs include:

Figure ES.3

Sources of Pollution Resulting in Swimming Beach Advisories and Closings (EPA 2003a)

EPA's Beaches Environmental Assessment and Coastal (BEACH) Program conducts an annual survey of the nation's swimming beaches. During the 2002 swimming season, CSOs and SSOs (including sewer line blockages and breaks) were responsible for 1 and 6 percent of reported closings and advisories, respectively.

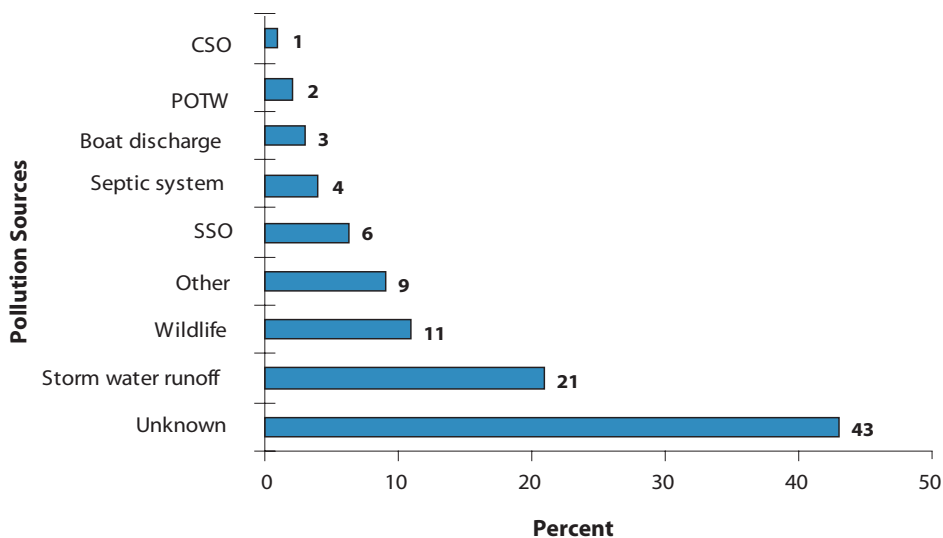

- The City of Indianapolis assessed receiving waters in the city and ranked CSOs high in importance relative to other sources of pollution.
- The State of North Carolina has documented fish kills attributed to SSOs since 1997.
- The State of New Jersey closed over 30,000 acres of classified shellfish growing areas in the Raritan Bay area due to a large SSO in 2003.

What is the Extent of Human Health Impacts Caused by CSOs and SSOs?

Microbial pathogens and toxics can be present in CSOs and SSOs at levels that pose risks to human health. Human health impacts occur when people become ill due to contact with water or ingestion of water or shellfish that have been contaminated by CSO or SSO discharges. In addition, CSSs

and SSSs can back up into buildings, including private residences. These discharges provide a direct pathway for human contact with untreated wastewater. Exposure to land-based SSOs typically occurs through the skin via direct contact. The resulting diseases are often similar to those associated with exposure through drinking water and swimming (e.g., gastroenteritis), but may also include illness caused by inhaling microbial pathogens.

Although it is clear that CSOs and SSOs contain disease-causing pathogens and other pollutants, EPA has limited information on actual human health impacts occurring as a result of CSO and SSO events. Further, CSOs and wet weather SSOs also tend to occur at times (e.g., storm events) when exposure potential may be lower.

Identification and quantification of human health impacts caused by CSOs and SSOs at the national

level is difficult due to a number of factors, including under-reporting and incomplete tracking of waterborne illness, contributions of pollutants from other sources, and the lack of a comprehensive national data system for tracking the occurrence and impacts of CSOs and SSOs. As an alternative to direct data on human health impacts, EPA modeled the annual number of gastroenteritis cases potentially occurring as a result of exposure to water contaminated by CSOs and SSOs at BEACH survey beaches. As shown in Table 6.6, EPA found that CSOs and SSOs are estimated to cause between 3,448 and 5,576 illnesses annually at the subset of recreational areas included in the analysis.

What Technologies Have Municipalities Used to Reduce the Impacts of CSOs and SSOs?

Municipalities have many options in selecting technologies to reduce the impacts of CSOs and SSOs. These technologies range from large-scale structural projects (e.g., wet weather storage facilities) to operation and maintenance practices (e.g., sewer cleaning). Technology selection is determined by characteristics of the sewer system, problems identified in the sewer system, performance goals established for the sewer system, resources available, and other site-specific considerations.

Municipalities employ a wide variety of technologies and operating practices to maintain existing infrastructure, minimize the introduction of unnecessary waste

and flow into the sewer system, increase capture and treatment of wet weather flow reaching the sewer system, and minimize the impact of any subsequent discharges on the environment and human health. For this Report to Congress, technologies used to address CSOs and SSOs have been grouped into five broad categories:

- Operation and maintenance practices
- Collection system controls
- Storage facilities
- Treatment technologies
- Low-impact development techniques

EPA, states, and municipalities have made progress in developing tools and strategies for reducing the frequency and volume of CSOs and SSOs.

Much remains to be done, however, to fully realize the objectives of the Clean Water Act and the CSO Control Policy. Municipalities have suggested that limited resources prevent them from acquiring and implementing technologies as quickly as they and regulatory agencies would prefer.

What Resources Have Municipalities Spent to Address the Impacts of CSOs and SSOs?

Municipal resources used to address CSOs and SSOs are documented in different ways. EPA's estimates of municipal CSO expenditures rely on requests for Clean Water State Revolving Loan Fund (CWSRF) loans and on documents submitted

to EPA's CWNS, which include CSO LTCPs and other facility planning documents. In addition, EPA uses a cost curve methodology to estimate costs for communities with CSSs that do not submit documentation. In communities served by SSSs, SSO control expenditures are generally a combination of general operation and maintenance (O&M) and capital expenditures. In total, EPA documented expenditures of more than \$6 billion on CSO control (through 2002) and at least \$4 billion on SSO control (1998-2002). EPA's 2000 CWNS estimated that at least an additional \$50.6 billion is required to capture no less than 85 percent of the CSO by volume, and an additional \$88.8 billion is required to control SSOs over the next 20 years (EPA 2003b).

What Actions Should be Taken to Reduce the Impacts of CSOs and SSOs?

In its preparation of this report, EPA found that:

Maintaining and improving the integrity of the nation's wastewater infrastructure will protect the high level of environmental quality and public health enjoyed in the United States. Proper O&M of the nation's sewers is integral to ensuring that wastewater is collected, transported, and treated at POTWs; and to reducing the volume and frequency of CSO and SSO discharges. Many existing structural and non-structural technologies are well suited for CSO and SSO control. Emerging technologies and innovative practices hold promise for even greater

reductions in pollution. Municipal owners and operators of sewer systems and wastewater treatment facilities need to manage their assets effectively and implement new controls, where necessary, as this infrastructure continues to age.

The impacts of CSOs and SSOs are a concern at the local watershed level.

CSOs and SSOs are two among many sources of pollutants that contribute to urban water quality problems. The watershed approach is central to water quality assessments and the identification of control strategies must include all sources of pollution affecting water quality. The presence of sewer systems in most developed watersheds nationwide underscores the importance of considering potential SSOs impacts on water quality. Similarly, the presence of CSOs in 32 states places them in many watersheds across the country. EPA, states, and municipalities should strive toward better integration of wet weather programs with other NPDES, compliance assistance, and enforcement activities. Better integration of programs and activities at the watershed level will provide economies of scale with respect to monitoring and reporting, protecting water quality, and reducing the impacts of CSOs and SSOs.

Improved monitoring and reporting programs would provide better data for decision-makers on CSO and SSO control. Better tracking of environmental impacts and the incidence of waterborne disease would increase national understanding of the environmental and human health impacts associated with CSOs, SSOs,

and other sources of pollution. Use of standardized reporting formats for information on the occurrence and control of CSOs and SSOs would enable EPA, states, and others to track pollutant loads and the performance of controls. Recent EPA efforts such as WATERS (Watershed Assessment, Tracking, and Environmental Results) work to unite national water quality information that was previously available only from several independent and unconnected databases. EPA will continue to work to improve the information available.

The success that the nation has achieved in improving water quality since passage of the Clean Water Act is due to the collective efforts of federal and state agencies, municipalities, industry, non-governmental organizations, and citizens. Continued

cooperation among these groups is essential to meet the challenges to clean water that lie ahead. As described in this Report to Congress, numerous pollutant sources threaten the environment and human health, but establishing direct cause-and-effect relationships is often difficult. The information necessary to manage water quality problems comes from many sources. EPA recognizes the value of working with stakeholders and has pursued a strategy of extensive stakeholder participation in its policy-making on CSO and SSO issues. Likewise, as communities continue to implement CSO and SSO controls, further cooperation with municipal, industry, and environmental organizations is essential to ensure successful development and implementation of environmental programs.

Chapter 1

Introduction

This Report to Congress presents U.S. Environmental Protection Agency’s (EPA or “the Agency”) most recent and comprehensive characterization of combined sewer overflows (CSOs) and sanitary sewer overflows (SSOs), including the extent of human health and environmental impacts caused by CSOs and SSOs, the resources spent by municipalities to address these impacts, and the technologies used by municipalities to address these impacts. This report has been prepared in direct response to a congressional mandate established in December 2000 in the Consolidated Appropriations Act for Fiscal Year 2001, P.L. 106-554, which requires that:

Not later than 3 years after the date of enactment of this Act, the Administrator of the Environmental Protection Agency shall transmit to Congress a report summarizing—

(A) the extent of human health and environmental impacts caused by municipal combined sewer overflows and sanitary sewer overflows, including the location of discharges causing such

impacts, the volume of pollutants discharged, and the constituents discharged;

(B) the resources spent by municipalities to address these impacts; and

(C) an evaluation of the technologies used by municipalities to address these impacts.

EPA prepared this report between March 2002 and July 2004. During this time, EPA developed a methodology; collected data from federal, state, and local sources; performed analyses; coordinated with stakeholders; and wrote this report. Data collection was completed in early fall 2003, and select analyses were updated in mid-2004. This report is the second Report to Congress required as part of P.L. 106-554. The first report was EPA’s *Report to Congress—Implementation and Enforcement of the Combined Sewer Overflow Control Policy* (EPA 833-R-01-003).

P.L. 106-554 also requires EPA to develop and maintain a clearinghouse of technologies for addressing the impacts of CSO and SSO discharges.

In this chapter:

- 1.1 What are CSOs and SSOs?
- 1.2 How is this Report Organized?



Typical CSO outfall discharge following a storm.

Photo: NJ Department of Environmental Protection

EPA expects that information provided in this Report to Congress will be the basis for the clearinghouse when it is developed.

1.1 What are CSOs and SSOs?

In the United States, two types of public sewer systems predominate: combined sewer systems (CSSs) and sanitary sewer systems (SSSs).

A CSS is a wastewater collection system owned by a municipality (as defined by Section 502(4) of the Clean Water Act) that conveys domestic, commercial, and industrial wastewater and storm water runoff through a single pipe system to a publicly-owned treatment works (POTW).

An SSS is a wastewater collection system owned by a municipality that conveys domestic, commercial, and industrial wastewater, and limited amounts of infiltrated groundwater and storm water to a POTW. Areas served by SSSs often have a municipal separate storm sewer system (MS4) to collect and convey runoff from rainfall and snowmelt.

1.1.1 CSOs

The term “CSO” refers to a discharge from a CSS at a point prior to the POTW treatment plant. CSOs generally occur in response to wet weather events; that is, during and following periods when rainfall or snowmelt drain to the CSS. Most CSSs are designed to discharge flows that exceed conveyance capacity directly to receiving waterbodies, such as rivers, streams, estuaries, and coastal waters.

CSSs can also back up into buildings, including private residences. When backups are caused by problems in the publicly owned portion of a CSS, they are considered unauthorized discharges.

CSO discharges include a mix of domestic, commercial, and industrial wastewater, and storm water runoff. As such, CSO discharges contain human, commercial, and industrial wastes as well as pollutants washed from streets, parking lots, and other surfaces. EPA’s 1994 CSO Control Policy (59 FR 18688) provides a comprehensive national strategy to ensure municipalities, NPDES permitting authorities, water quality standards authorities, EPA, and the public to engage in a coordinated planning effort to achieve cost-effective CSO controls that ultimately meet the requirements of the Clean Water Act (EPA 1994a). The text of the CSO Control Policy is provided in Appendix A. In 2000, P.L. 106-554 amended the Clean Water Act by adding the following to Section 402:

(q)(1) Each permit, order, or decree issued pursuant to this Act after the date of enactment of this subsection for a discharge from a municipal combined storm and sanitary sewer shall conform to the CSO Control Policy signed by the Administrator on April 11, 1994.

EPA’s *Report to Congress—Implementation and Enforcement of the Combined Sewer Overflow Control Policy* identified CSSs in 32 states (including the District of Columbia) across nine EPA regions (EPA 2001a). As of July 2004, those 32 states had issued 828 permits to 746 communities.

1.1.2 SSOs

The term “SSO” refers to untreated or partially treated sewage releases from an SSS.

SSOs have a variety of causes, including, but not limited to, severe weather, blockages, line breaks, power failures, lapses in sewer system operation and maintenance, inadequate sewer design and construction, and vandalism. SSO discharges typically contain a mix of domestic, commercial, and industrial waste. SSOs can pose challenging public health and environmental issues when they occur.

SSOs include those overflows that reach waters of the United States, as well as overflows out of manholes and onto city streets, sidewalks, and other terrestrial locations. A limited number of municipalities have regular SSO discharges from fixed points within the sewer system. SSSs can back up into buildings, including private residences. When backups are caused by problems in the publicly-owned portion of an SSS, they are considered SSOs.

SSOs that reach waters of the United States are point source discharges, and, like other point source discharges from municipal SSSs, are prohibited unless authorized by an National Pollutant Discharge Elimination System (NPDES) permit. Moreover, SSOs, including those that do not reach waters of the United States, may be indicative of improper operation and maintenance of the sewer system, and thus may violate NPDES permit conditions. EPA has focused

on SSO problems with compliance assistance and enforcement activities in accordance with the *Compliance and Enforcement Strategy Addressing Combined Sewer Overflows and Sanitary Sewer Overflows*, issued April 27, 2000 (EPA 2000b). In addition, EPA is evaluating options for improving NPDES permit requirements for SSOs and municipal SSSs.

EPA’s *2000 Clean Watersheds Needs Survey Report to Congress* reported 15,582 municipal SSSs providing wastewater collection, conveyance, and treatment are presently operating within the 50 states and the District of Columbia (EPA 2003b). EPA also identified an additional 4,846 satellite SSSs providing only collection and conveyance. Not all of these hold NPDES permits (EPA 2003b). If not properly maintained, satellite systems have the potential to have an SSO or to cause an SSO in downsewer systems.



Since the passage of the Clean Water Act in 1972, all levels of government have made substantial investments in the nation’s wastewater infrastructure.

Photo: City of Chicago

1.2 How is this Report Organized?

The purpose of this report is to respond to Congress with a current characterization of the volume, frequency, and location of CSOs and SSOs, the extent of human health and environmental impacts caused by CSOs and SSOs, the resources spent by municipalities to address these impacts, and the technologies used to address these impacts. The report contains 10 chapters; the content and purpose of which are summarized below.

Chapter 2 summarizes the history of regulatory efforts to control CSOs and SSOs. It describes federal water pollution control legislation, paying particular attention to Clean Water Act requirements for secondary treatment and pretreatment, the Construction Grants Program, and amendments to the Clean Water Act made by P.L. 106-554.

Chapter 3 describes the methodology used to develop this Report to Congress. In order to report on impacts, resources spent to address impacts, and the technologies applied to control CSOs and SSOs, EPA designed and implemented a comprehensive approach to gather the necessary data and information. This effort included an extensive literature search, site visits to EPA regional offices and states, interviews with state and local officials, an experts workshop, and outreach to stakeholders.

Chapter 4 characterizes the pollutants present in CSO and SSO discharges and identifies other watershed sources of these pollutants. This chapter describes the universe of CSS and SSS permittees under the NPDES program. The chapter also summarizes information on the volume, frequency, and location of CSOs and SSOs, as well as the most common causes of SSOs.

Chapter 5 describes the types of environmental impacts attributable to CSO and SSO discharges in terms of water quality standards violations and lost uses (i.e., closures of shellfish beds and beaches). This chapter also discusses the extent of environmental impacts caused or contributed to by

CSO and SSO discharges. National data are used to describe the extent of environmental impacts. State and local data are used to illustrate site-specific examples of impacts.

Chapter 6 describes waterborne diseases and other potential human health impacts associated with exposure to the pollutants found in CSO and SSO discharges. The chapter summarizes mechanisms at the federal, state, and local levels for reporting and tracking these impacts. In addition, the chapter describes different techniques used to communicate the risk associated with exposure to CSO and SSO discharges and how these risks can be minimized or prevented.

Chapter 7 summarizes federal and state activities to regulate CSOs and SSOs to minimize impacts associated with discharges. The chapter reports on the issuance of permits and other enforceable orders requiring control of CSOs or elimination of SSOs. This chapter also summarizes technical assistance provided by federal and state governments to assist municipalities in controlling CSOs and SSOs.

Chapter 8 surveys the technologies most widely used to control CSO and SSO discharges, including: operation and maintenance practices, sewer system controls, storage facilities, treatment technologies, and low-impact development techniques. The chapter also describes effective combinations of technologies as well as emerging practices that show particular promise in the control of CSOs and SSOs.

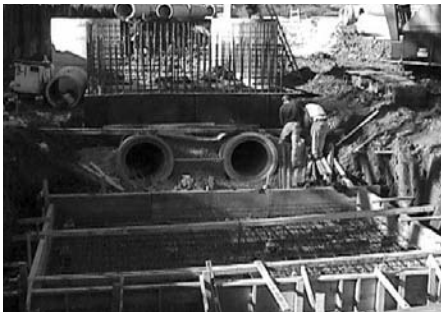

Sewer separation is one of the most often used CSO controls. The separation project shown here is underway in Louisville, Kentucky.

Photo: Louisville-Jefferson County Metropolitan Sewer District

Chapter 9 provides information on the resources spent by municipalities to control CSO and SSO discharges, including a discussion of the national investment in wastewater infrastructure. Specific information from select municipalities on expenditures related to CSO and SSO control is presented. The chapter summarizes projected financial needs for municipalities to meet current

regulatory requirements for CSO and SSO control and discusses available sources of funding to address impacts of CSOs and SSOs.

Chapter 10 summarizes report findings and key considerations for EPA in shaping future regulations and program activities aimed at CSO and SSO control.

Chapter 2

Background

Municipal sewer systems are an extensive and valuable part of the nation's infrastructure. In 2000, 16,202 wastewater treatment facilities and 21,264 sewer systems (both CSS and SSS) were in operation in the United States. These systems serve about 208 million people in the United States, as reported in EPA's *Clean Watersheds Needs Survey 2000 Report to Congress* (EPA 2003b). EPA estimates that publicly-owned sewer systems account for about 724,000 miles of sewer pipe and approximately 500,000 miles of privately-owned pipes deliver wastewater into these systems.

Much of the nation's wastewater infrastructure is aging. Components of some sewer systems date back over 100 years, as evidenced by wood and brick sewers still in operation in some cities. A survey of 42 wastewater utilities indicated the age of sewer system components ranged from new to 117 years, with an average age of 33 years (ASCE 1999). Over time, municipalities have used a wide variety of materials, design and installation practices, and maintenance and

repair procedures, which has led to considerable variability in the current condition of sewer infrastructure.

This chapter provides a brief history of sewer systems and wastewater treatment in the United States, using context provided by the Clean Water Act. Additional information on federal and state efforts related to the control of CSOs and SSOs is presented in Chapter 7.

2.1 What is the History of Sewer Systems in the United States?

In the pre-sewer era, human waste was dumped into privy vaults and cesspools, and storm water ran into the streets or into surface drains. Population increases during the 1800s, particularly in urban areas, created the need for more effective sanitary systems. Between 1840 and 1880, the percentage of Americans living in urban areas rose from 11 percent to 28 percent (Burian et al 1999). This rapid urbanization resulted in increased quantities of wastewater that

In this chapter:

- 2.1 What is the History of Sewer Systems in the United States?
- 2.2 What is the History of Federal Water Pollution Control Programs?
- 2.3 What is the Federal Framework for CSO Control?
- 2.4 What is the Federal Framework for SSO Control?
- 2.5 What is the Wet Weather Water Quality Act?

overwhelmed privy vaults and cesspool systems. Consequently, municipalities began installing sewer systems to protect public health and to address aesthetic and flooding concerns (Melosi 2000). Little precedent existed for the construction of underground sewer systems, however, and engineers were reluctant to experiment with expensive capital works (Tarr 1996). In 1858, the first comprehensive sewer system was designed for the city of Chicago (Burian et al. 1999). Extensive construction of municipal sewer systems did not start until the 1880s.

- *Combined sewer systems* – domestic, commercial, and industrial wastewater, and storm water runoff are collected and conveyed in a single pipe system, as shown in Figure 2.1; or
- *Separate sanitary sewer and storm sewer systems* – domestic, commercial, and industrial wastewater, and storm water runoff are collected and conveyed using two separate systems of pipe, as shown in Figure 2.2.

Combined sewer systems were less expensive for municipalities that needed both sanitary and storm sewers, while SSSs were less expensive

In the United States, municipalities installed sewer systems using two predominant design options:

Figure 2.1

Typical Combined Sewer System

Combined sewer systems are designed to discharge directly to surface waterbodies such as rivers, estuaries, and coastal waters during wet weather, when total flows exceed the capacity of the CSS or treatment plant.

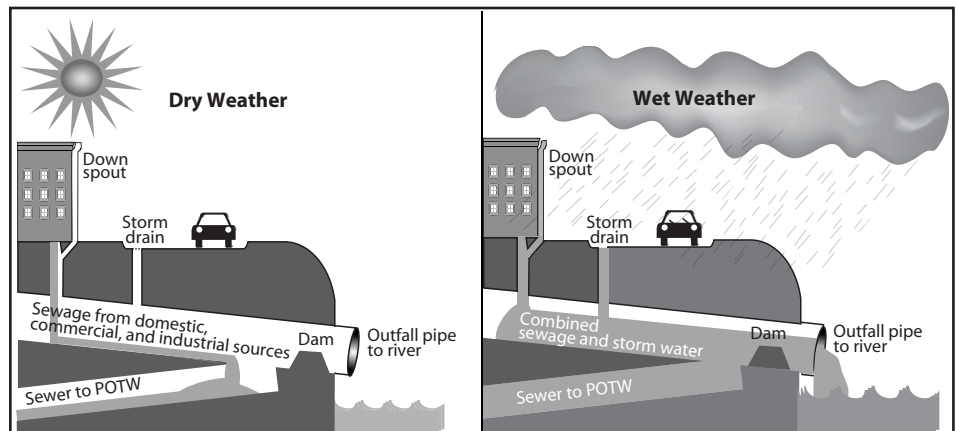
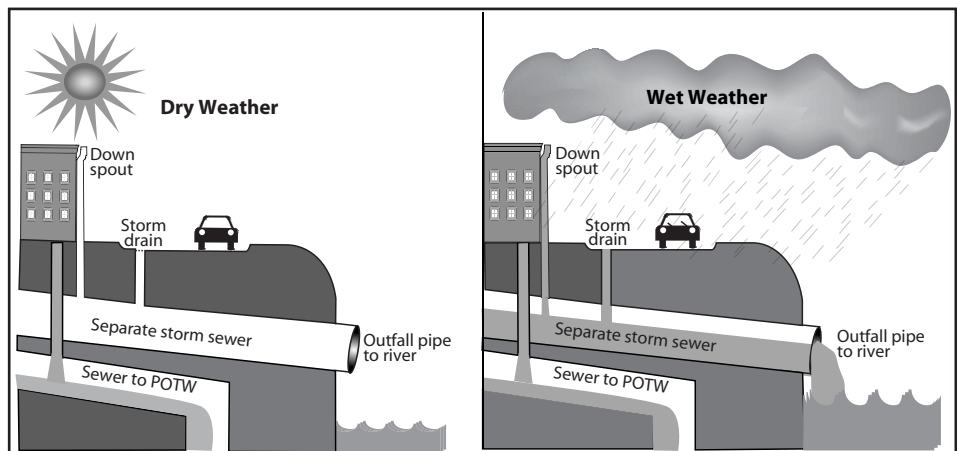

Figure 2.2

Typical Separate Sanitary and Storm Sewer Systems

Sanitary sewer systems are designed to collect and convey wastewater mixed with limited amounts of infiltration and inflow to a treatment plant. A separate storm sewer system is used in many areas to collect and convey storm water runoff directly to surface waterbodies.



for municipalities that needed only a wastewater collection system. Sanitary sewers were sized to convey domestic, commercial, and industrial wastewater, and limited amounts of infiltrated groundwater and storm water inflow. Unlike CSSs, they were not intended to collect large amounts of runoff from wet weather events. In general, large cities tended to construct CSSs, given the flood control advantages offered by such systems. By the end of the 19th century, most of the large urban areas with sewer systems had CSSs. Smaller communities generally pursued construction of separate sanitary and storm sewers (Melosi 2000).

At the time, sanitary engineers thought that both CSSs and SSSs provided roughly equivalent health protection, as neither design included wastewater treatment (Tarr 1996). This view was supported by an 1881 report to the National Board of Health that recommended that design choice be based on local conditions and financial considerations (Hering 1977).

Construction of sewer systems greatly improved local sanitary conditions and in many cases reduced illness. The direct discharge of untreated wastewater to local receiving waters, however, adversely impacted downstream communities. During the 1880s and 1890s, the rate of typhoid deaths rose in cities with drinking water intakes downstream of untreated wastewater discharges. Bacterial analysis confirmed the link between sewage pollution in rivers and epidemics of certain diseases (Tarr 1996). Large outbreaks of

cholera, which claimed thousands of lives, were also linked to sewage-contaminated water supplies (Snow 1936). As a result, views on the safety of discharging untreated wastewater directly to receiving waters began to shift toward the end of the 19th century.

As the need to provide wastewater treatment was recognized, the major design difference between CSSs and SSSs became apparent. Although combined sewers offered an efficient means of collecting and conveying storm water and wastewater, they made treatment more difficult due to the large variation in flows between dry and wet weather conditions. Sanitary sewer systems simplified and lowered the cost of wastewater treatment, due to significantly smaller volumes of wet weather flows (Burian et al. 1999). Nonetheless, municipalities with CSSs often continued to utilize and expand the areas served by such systems (Tarr 1996).

Centralized municipal wastewater treatment was still in its infancy in the late 1800s (Burian et al. 1999). In 1892, only 27 municipalities treated their wastewater; of these, 26 had SSSs.

2.1.1 Combined Sewers and CSOs

CSOs are primarily caused by wet weather events (e.g., rainfall or snowmelt), when the combined volume of wastewater and storm water entering the system exceeds the capacity of the CSS or treatment plant. When this occurs, combined systems overflow directly to a receiving water. Overflow frequency and duration varies both from system to system and



Privy vaults and a water pump are located side by side in this Pittsburgh neighborhood, circa 1909.

Photo: Paul Underwood Kellog

from outfall to outfall within a single CSS. Some CSO outfalls discharge infrequently, while others activate every time it rains. When constructed, CSSs were typically sized to carry three to five times the average dry weather flow. Thus, there is usually considerable conveyance capacity within a CSS during dry weather. Discharges from a CSS during dry weather, referred to as dry weather overflows, are infrequent and are prohibited under the NPDES program.

most of the communities served by CSSs are located in the Northeast and Great Lakes regions, while relatively few are located in the Midwest, Southeast, and Pacific Northwest. Currently, 828 NPDES permits authorize discharges from 9,348 CSO outfalls in 32 states (including the District of Columbia).

2.1.2 Sanitary Sewers and SSOs

SSOs include unauthorized discharges from SSSs that reach waters of the United States, as well as overflows out of manholes and onto city streets, sidewalks, and other terrestrial locations. A limited number of municipalities have SSO discharges

Figure 2.3

National Distribution of Communities Served by CSSs

CSSs are found throughout the United States, but are most heavily concentrated in the Northeast and Great Lakes regions.

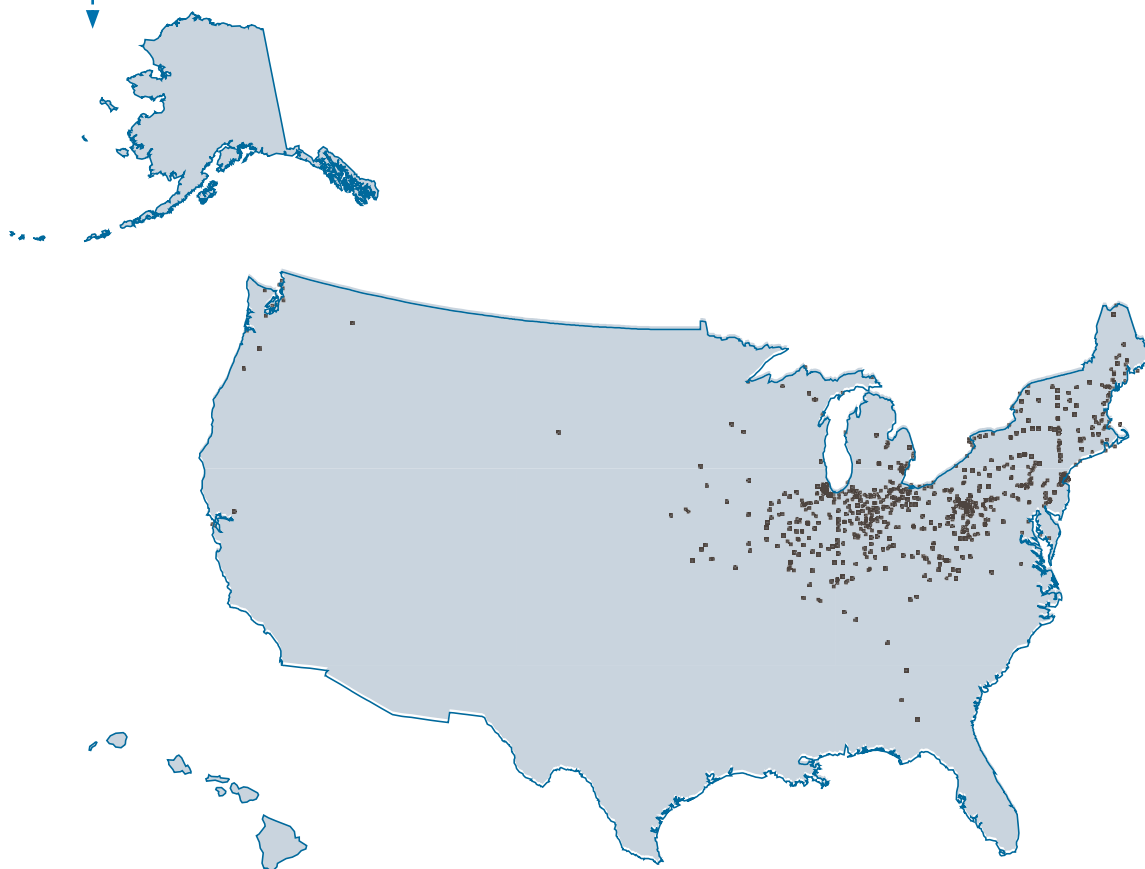

from fixed points within the sewer system, similar to CSO outfalls.

SSOs, including those that do not reach waters of the United States, may be indicative of improper operation and maintenance of the sewer system. Causes of SSOs include, but are not limited to:

- Blockages
- Structural, mechanical, or electrical failures
- Collapsed or broken sewer pipes
- Insufficient conveyance capacity
- Vandalism

In addition, high levels of infiltration and inflow (I/I) during wet weather can cause SSOs. Many SSSs that were designed according to industry standards experience wet weather SSOs because levels of I/I may exceed levels originally expected; removal of I/I has proven more difficult and costly than anticipated; or the capacity of the system has become inadequate due to an increase in service population without corresponding system upgrades. SSSs are located across the country, as presented in Figure 2.4. EPA believes that all SSSs have the potential to have occasional SSOs.

Figure 2.4

National Distribution of Communities Served by SSSs

SSSs are located in all 50 states, but are concentrated in the eastern half of the United States and on the west coast. SSSs are shown for approximately 75 percent of systems, where locational data (latitude/longitude) were available from EPA's Permit Compliance System.

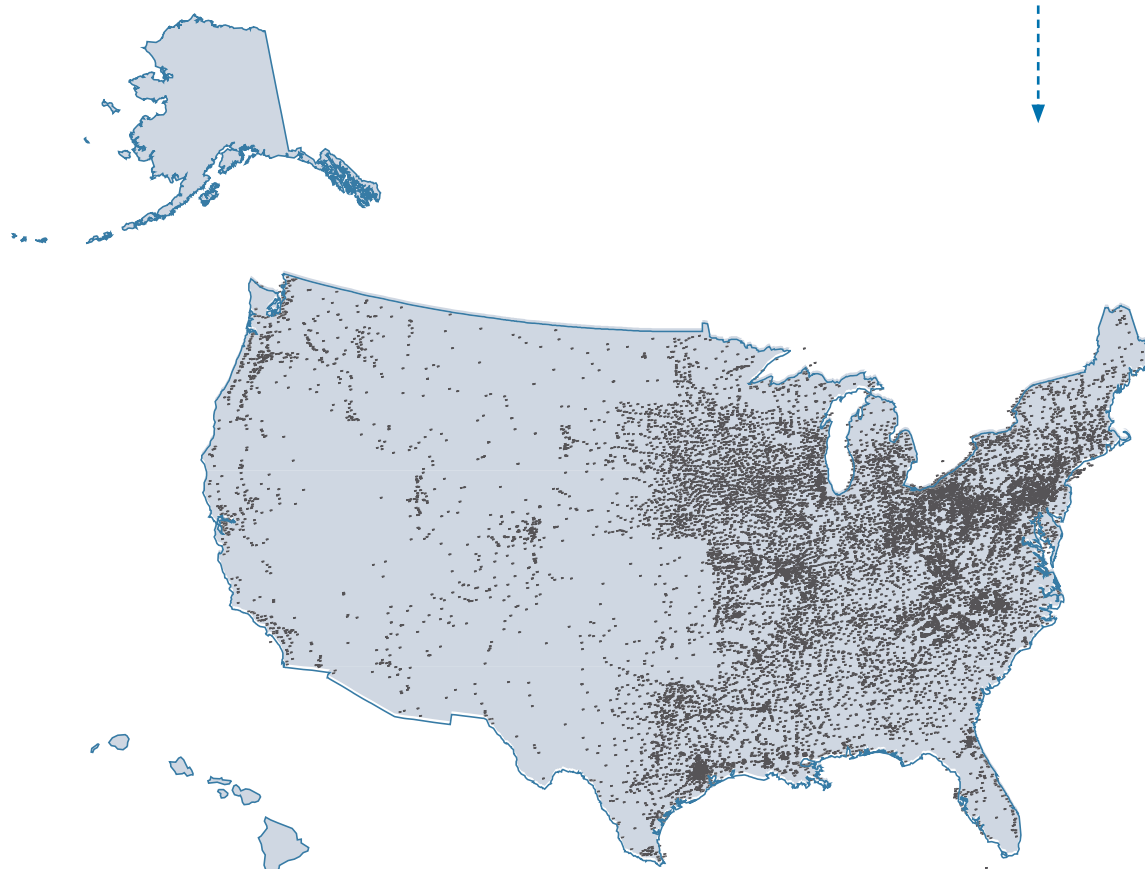

2.2 What is the History of Federal Water Pollution Control Programs?

The desire for a federal water pollution control program increased steadily through the first half of the 20th century. Congress and the public became more aware of the environmental and human health impacts resulting from direct discharges of untreated wastewater to local receiving waters. Recognizing the national interest in abating water pollution for the benefit of water supply and water resources, the 80th Congress stated:



San Francisco's CSO Oceanside Water Pollution Control Plant treats an average of 17 million gallons per day (mgd) during dry weather and has 65 mgd of peak flow capacity.

Photo: San Francisco Public Utilities Commission

"The pollution of our water resources by domestic and industrial wastes has become an increasingly serious problem for the rapid growth of our cities and industries. . . Polluted waters menace the public health through the contamination of water and food supplies, destroy fish and game life, and rob us of other benefits of our natural resources." (Senate Report No. 462 of the 80th Congress, 1948)

In 1948, Congress passed the Federal Water Pollution Control Act (FWPCA), P.L. 80-845, creating a legislative basis for water pollution control in the United States. The original FWPCA was amended many times (in 1956, 1961, 1965, 1966, 1970, 1972, 1977, 1981, and 1987). Notably, the 1972 Amendments (P.L. 92-500), commonly known as the Clean Water Act, restructured the authority for water pollution control and consolidated that authority in the Administrator of the EPA. The Clean Water Act provided a framework for:

- Prohibition of point source discharges except as authorized by a permit;
- Establishment of the National Pollutant Discharge Elimination System (NPDES), a regulatory program that requires "point source" dischargers, such as municipal wastewater collection and treatment plant operators, to obtain a permit and meet applicable regulations issued under the Clean Water Act;
- Development of technology-based effluent limits, based on the pollutant reduction capacity of demonstrable treatment technologies, to be met by NPDES permit holders; and
- Water quality standards and water quality-based effluent limitations, where technology-based limits are inadequate to meet state water quality standards.

As a result of investment in wastewater treatment, the United States has realized major improvements in environmental quality and human health. Widespread epidemics of typhoid fever and cholera that killed thousands of people in the 19th century and early 20th century were brought under control and have remained under control due to disinfection of drinking water supplies and advances in wastewater treatment.

2.2.1 Secondary Treatment

Many of the first wastewater treatment facilities were designed to simply separate solids and floating debris from wastewater prior to discharge; this process is often referred to as

primary treatment (Rowland and Heid 1976). This modest level of treatment, however, was unable to offset increased pollutant loads associated with rapidly growing urban populations and associated increases in the volume of wastewater generated. An additional level of treatment was needed to protect the quality of the nation's waters.

The 1972 Clean Water Act provided the first statutory requirement for achievement of effluent limits based on secondary treatment by POTWs. Specifically, Section 301 of the Clean Water Act required POTWs to meet limits based on secondary treatment by July 1, 1977. EPA developed limits based on secondary treatment to include maximum allowable concentrations of key parameters as well as percent removal requirements. Limits based on secondary treatment include maximum acceptable concentrations for biochemical oxygen demand measured over five days (BOD₅), total suspended solids (TSS), and pH. Percent removal requirements for BOD₅ and TSS were also included. Adjustments to percent removal requirements are available, on a case-by-case basis, for POTWs with less-concentrated influent that may prevent compliance with the standard requirements (EPA 2000a).

2.2.2 Construction Grants

In addition to establishing effluent limits for POTWs, the FWPCA and its amendments brought about substantial investment in wastewater treatment between the 1940s and the present. The 1956 Amendments (P.L. 84-660) established the Construction

Grants Program for the construction of wastewater treatment facilities and provided \$150 million in funding for the program. Additional construction grant funding was authorized with the 1961, 1965, and 1966 amendments. With passage of the Clean Water Act in 1972, funding for the Construction Grants Program dramatically increased. EPA's Construction Grants Program distributed \$100.7 billion (2002 dollars) to communities between 1970 and 1995 (EPA 2000a). The 1987 amendments to the Clean Water Act transformed the financial assistance from a grant program to a loan program. The Construction Grants Program was phased out by 1991 and replaced by the State Revolving Fund (SRF) program.

Federal funding provided a strong impetus for constructing and upgrading wastewater infrastructure. The level of treatment provided at POTWs improved substantially over the last 50 years (EPA 2000a):

- 30 percent of POTWs (3,529 of 11,784) provided secondary treatment in 1950.
- 72 percent of POTWs (10,052 of 14,051) provided secondary treatment in 1968.
- 99 percent of 16,024 POTWs provided secondary or greater treatment, or were “no-discharge facilities,” in 1996.

High levels of compliance with secondary treatment requirements resulted in notable decreases in pollutant loadings from POTWs, even as the service population increased. As an example, the amount of BOD₅ discharged from POTWs declined by

about 23 percent between 1968 and 1996, despite a 35 percent increase in influent loadings to POTWs during the same period (EPA 2000a).

2.2.3 Pretreatment

In the mid-1980s, more than one-third of all toxic pollutants entering the nation's waters were discharged from POTWs (EPA 1986a). POTWs are not typically designed to remove toxic pollutants, and in some cases constituents in industrial wastewater can actually interfere with the removal of conventional pollutants such as BOD₅ and TSS. To address the discharge of toxic pollutants, EPA, pursuant to Clean Water Act Section 307, established the National Pretreatment Program. The National Pretreatment Program requires that industrial and commercial dischargers treat or control toxic pollutants in their wastewater prior to discharge to a municipal sewer system.

The General Pretreatment Regulations require all large POTWs (i.e., those designed to treat flows of more than 5 million gallons per day (mgd)) and smaller POTWs with significant industrial users to establish local pretreatment programs. These local programs implement national pretreatment standards and requirements in addition to any more stringent local requirements necessary to protect site-specific conditions. More than 1,500 POTWs have developed and are implementing local pretreatment programs designed to control discharges from approximately 30,000 significant industrial users. The National Pretreatment Program has made great strides in reducing the

discharge of toxic pollutants to sewer systems and to waters of the United States (EPA 1999a).

2.2.4 Wet Weather

Initial implementation of the Clean Water Act during the 1970s and 1980s focused on discharges from traditional point sources of pollution, such as POTWs and industrial facilities. Beginning in the late 1980s, attention shifted to wet weather sources of pollution. Under the NPDES program, four program areas address wet weather discharges: CSOs, SSOs, storm water, and concentrated animal feeding operations (CAFOs).

Storm Water

EPA published Phase I of the NPDES Storm Water Program in 1990 (55 FR 47990). Phase I applies to large dischargers; that is, those associated with industrial activities, municipal separate storm sewer systems serving 100,000 people or more, and construction projects disturbing more than five acres of land. In 1999, EPA published the Phase II Final Rule, which requires NPDES permit coverage for storm water discharges from smaller sources, including cities and towns in urban areas with separate storm sewer systems serving fewer than 100,000 people, and smaller construction projects that disturb less than five acres (64 FR 68722).

CAFOs

CAFOs are point sources, as defined by Clean Water Act Section 502(14). On February 12, 2003, EPA published the Concentrated Animal Feeding Operations Rule to ensure that manure



Some municipalities promote storm drain stenciling as a storm water pollution prevention measure.

Photo: EPA

and wastewater from CAFOs are properly managed to protect the environment and public health (68 FR 7175).

2.2.5 Watershed-Based Permitting

On December 17, 2003, EPA published the Watershed-Based NPDES Permitting Implementation Guidance (EPA 2003c). Watershed-based permitting under the NPDES program emphasizes addressing all stressors (including CSOs and SSOs) within a watershed, rather than individual pollutant sources on a discharge-by-discharge basis. The watershed-based permitting approach is supported by EPA as a cost-effective mechanism for improving water quality and meeting watershed goals. The approach builds on watershed policy and guidance developed during the 1990s: EPA's Watershed Strategy, Watershed Framework, and Clean Water Action Plan (EPA 1994b, 1996a, EPA and USDA 1998). In addition, the approach fulfills commitments articulated in recent initiatives such as EPA's Trading Policy and Watershed-Based Permitting Policy Statement (EPA 2003d, 2003e).

Watershed-based permitting can encompass a variety of activities ranging from synchronizing NPDES permits within a basin to developing water quality-based effluent limits using a multiple discharger modeling analysis. Within a broader watershed management system, the watershed-based permitting approach is a tool that can assist with implementation activities such as monitoring, reporting, and assessment.

2.3 What is the Federal Framework for CSO Control?

CSOs are point source discharges and are subject to NPDES permit requirements. CSOs are not subject to limits based on secondary treatment requirements otherwise applicable to POTWs. Permits for CSOs must include technology-based effluent limits, based on the application of best available technology economically achievable (BAT) for toxic and non-conventional pollutants and best conventional pollutant control technology (BCT) for conventional pollutants. Additionally, like all NPDES permits, permits authorizing discharges from CSO outfalls must include more stringent water quality-based requirements, when necessary, to meet water quality standards. The development of the federal framework to address CSOs is described in detail below.

2.3.1 CSO Case Law

In 1980, the U.S. Court of Appeals for the D.C. Circuit accepted EPA's interpretation of the Clean Water Act that discharges at CSO outfalls are not discharges from POTWs and thus are not subject to the limits based on secondary treatment standards otherwise applicable to POTWs (*Montgomery Environmental Coalition vs. Costle*, 46 F2d 568 (D.C. Cir. 1980)). Following this decision, EPA and states renewed their focus on permit requirements for CSO discharges under the NPDES program.



The sewer utility serving Louisville, Kentucky, has restructured its organization to coordinate CSO control needs with other water quality improvement programs as part of an effort to move toward watershed-based permitting.

Photo: Louisville-Jefferson County Metropolitan Sewer District

2.3.2 The National CSO Control Strategy and the MAG

In 1989, EPA issued the National CSO Control Strategy (54 FR 37371). The National CSO Control Strategy encouraged states to develop statewide permitting strategies to ensure all CSOs were subject to an NPDES permit and recommended six minimum measures for CSO control; additional controls could be required as necessary. As EPA, states, and municipalities worked to implement the National CSO Control Strategy in the early 1990s, the impacts of CSOs (discussed in Chapters 5 and 6 of this report) continued to receive national attention. Environmental interest groups pushed for further action, while municipal organizations, concerned that the National CSO Control Strategy did not provide sufficient clarity, sought a consistent national approach to CSO control. In response to these concerns, EPA formed a Management Advisory Group (MAG) in 1992. The MAG included representatives from states, municipalities, industry associations, and environmental interest groups.



A CSO outfall in Wilmington, Delaware.

Photo: Wilmington Department of Public Works

2.3.3 The CSO Control Policy

EPA published the CSO Control Policy on April 19, 1994 (59 FR 18688). The purpose of the CSO Control Policy was twofold: 1) to elaborate on EPA's 1989 National CSO Control Strategy; and 2) to expedite compliance with Clean Water Act requirements. The policy sought to minimize adverse impacts

from CSOs on water quality, aquatic biota, and human health (EPA 1994a).

EPA's CSO Control Policy assigns primary responsibility for its implementation and enforcement to NPDES authorities and water quality standards authorities. This policy also established objectives for CSO communities: 1) to implement the nine minimum controls (NMC) and submit documentation on NMC implementation; and 2) to develop and implement a long-term control plan (LTCP). Implementation status of the NMC and LTCPs is presented in Chapter 7. More information on the CSO Control Policy is provided in EPA's *Report to Congress—Implementation and Enforcement of the Combined Sewer Overflow Control Policy* (EPA 2001a).

2.4 What is the Federal Framework for SSO Control?

SSOs that reach waters of the United States are point source discharges and, like other point source discharges from municipal SSSs, are prohibited unless authorized by an NPDES permit. Moreover, SSOs, including those that do not reach waters of the United States, may be indicative of improper operation and maintenance of the sewer system, and thus may violate NPDES permit conditions. In the 1989 National CSO Control Strategy, EPA explained that:

“sanitary sewer systems must adhere to the strict design and operational standards established to protect the integrity of the sanitary sewer system and wastewater treatment facilities.”

In 1994, a number of municipalities asked EPA to establish an SSO Federal Advisory Committee (FAC) of key stakeholders to make recommendations on how the NPDES program should address SSOs. The municipalities indicated a desire for greater national clarity, consistency in NPDES requirements applicable to SSOs, and a workable regulatory framework. Five general stakeholder groups were represented in the SSO FAC: sanitary sewer system operators, SSO-related health professionals, state regulatory agencies, technical professionals, and environmental and citizen groups.

In 1995, EPA chartered an Urban Wet Weather Flows FAC with stakeholder representation to address cross-cutting issues associated with wet weather discharges (i.e., CSOs, SSOs, and storm water). The Urban Wet Weather Flows FAC formed its SSO Subcommittee by reconvening the SSO FAC established in 1994. The SSO Subcommittee was tasked with developing a framework for addressing SSOs and their impacts through regulatory and non-regulatory actions.

Between 1995 and 1999, the SSO Subcommittee held 12 meetings and

developed a number of documents, including a series of issue papers and a draft comprehensive guidance document. In January 2001, EPA prepared a notice of proposed rulemaking related to SSOs, which was withdrawn for review before it was published in the Federal Register. EPA is considering various options for moving forward.

2.5 What is the Wet Weather Water Quality Act?

In December 2000, as part of the Consolidated Appropriations Act for Fiscal Year 2001 (P.L. 106-554), Congress amended the Clean Water Act by adding Section 402(q). This amendment is commonly referred to as the Wet Weather Water Quality Act of 2000. Section 402(q) requires that each permit, order, or decree issued pursuant to the Clean Water Act after the date of enactment for a discharge from a municipal combined sewer system shall conform to the CSO Control Policy. It authorized a \$1.5-billion grant program for controlling CSOs and SSOs. Section 402(q) also required EPA to issue guidance to facilitate the conduct of water quality and designated use reviews for CSO receiving waters. EPA issued this guidance on August 2, 2001 (EPA 2001b).

Chapter 3

Methodology

This chapter documents the methodology EPA used to prepare this Report to Congress. It presents EPA's study objectives and analytical approach, and summarizes the steps EPA has taken to compile information on the impacts and control of CSOs and SSOs. This chapter describes EPA's data sources, explains information collection methods, and outlines the steps EPA took to involve stakeholders in the development of this report. The chapter also summarizes data considerations and quality assurance measures used to enhance the accuracy and precision of results.

3.1 What Study Objectives and Approach Did EPA Use to Prepare this Report?

The overall objective for this report is to respond to Congress with a current characterization of the volume, frequency, and location of CSOs and SSOs; the extent of human health and environmental impacts caused by CSOs and SSOs; the resources spent

by municipalities to address these impacts; and the technologies used to address these impacts. Some new data were obtained through interviews in the development of this report, but EPA did not undertake surveys or field monitoring to characterize CSOs, SSOs, and their impacts. Instead, EPA primarily emphasized the collection, compilation, and analysis of existing data.

EPA used a two-tiered approach to address the questions posed by Congress. The first tier focused on national assessments, drawing on existing data collected by EPA and other federal agencies to the fullest extent possible. These data were supplemented with select data from non-governmental organizations that were also national in scope. The second tier focused on the use of anecdotal data to provide site-specific examples of impacts, costs, and technology applications, and to demonstrate the significance of CSOs and SSOs at the local level. Site-specific examples were largely drawn from state and local interviews and reports.

In this chapter:

- 3.1 What Study Objectives and Approach Did EPA Use to Prepare this Report?
- 3.2 What Data Sources Were Used?
- 3.3 What Data Were Collected?
- 3.4 How Were Stakeholders Involved in the Preparation of this Report?
- 3.5 What Data Considerations Are Important?
- 3.6 What Quality Control and Quality Assurance Protocols Were Used?
- 3.7 Summary

3.2 What Data Sources Were Used?

EPA developed a comprehensive list of potential data sources that could be used to characterize CSOs and SSOs, including environmental and human health impacts from the discharges, technologies used to control the discharges, and the costs of the control measures. This list included:

- Federal data sources
- NPDES authority and other state program data sources
- Community-level data sources
- Non-governmental organization data sources

The following sections describe specific data sources EPA used to develop this report.

3.2.1 Federal Data Sources

EPA researched its own files and library of CSO- and SSO-related documents for data that could be used to characterize CSOs and SSOs. Data and reports relevant to CSOs and SSOs developed by EPA's permitting, compliance and enforcement, research and development, and water quality assessment programs were among those reviewed. Specific EPA data sources used in the analysis for this Report to Congress include:

Beaches Environmental Assessment and Coastal Health (BEACH) Program.

The BEACH Program focuses on improving public health and environmental protection programs for beachgoers and providing the

public with information about the quality of beach water.

Clean Watersheds Needs Survey (CWNS). The CWNS summarizes estimated capital costs for water quality projects including projects to control CSOs and SSOs.

Enforcement and Compliance Docket (ECD). The ECD is the central archive for all documents related to EPA's enforcement and compliance activities. It contains regulatory, case settlement, and other policy related information.

EPA's 2001 *Report to Congress—Implementation and Enforcement of the Combined Sewer Overflow Control Policy.* The 2001 Report to Congress provides a comprehensive national inventory of active CSO permits.

Government Performance and Results Act (GPRA). EPA selected the CSO program as a GPRA pilot program for tracking programmatic benefits in 1997.

Municipal Technology Fact Sheets. EPA maintains a series of more than 100 technology fact sheets, including more than 20 with application to the control of CSOs and SSOs.

National Water Quality Inventory (NWQI). The biennial NWQI Report to Congress is the primary vehicle for informing Congress and the public about general water quality conditions in the United States.

Office of Research and Development (ORD) projects. ORD works with industry, universities, and other agencies to develop technologies and

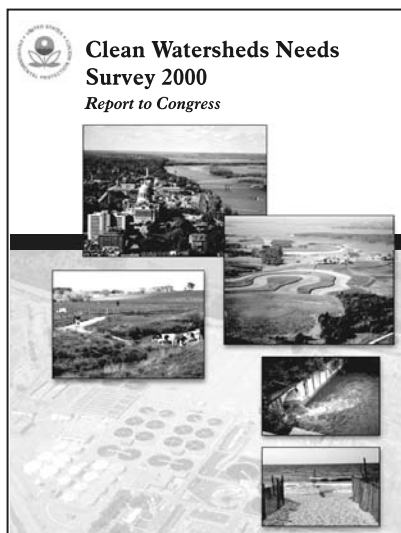

techniques for protecting the nation’s freshwater and coastal resources and human health.

Permit Compliance System (PCS). PCS provides information on point sources holding NPDES permits, including permit issuance and expiration dates, discharge limits, and discharge monitoring data.

EPA also researched the programs and files of other federal agencies to ensure that relevant data from other federal programs and activities were assessed and included in this report, as appropriate. The agencies consulted included:

- Centers for Disease Control and Prevention (CDC)
- Congressional Budget Office (CBO)
- Government Accounting Office (GAO)
- National Institutes of Health (NIH)
- National Oceanic and Atmospheric Administration (NOAA)
- United States Geological Survey (USGS)

3.2.2 NPDES Authority and Other State Program Data Sources

Individual NPDES authorities and associated state programs were the primary sources of data on the location of CSO outfalls as well as the frequency, volume, and cause of SSO events. EPA conducted interviews with states to assess the availability of data. State program data and interviews with program staff were also used to

identify site-specific CSO- and SSO-related examples of environmental and human health impacts such as fish kills, beach closures, and outbreaks of waterborne disease.

3.2.3 Community-Level Data Sources

EPA identified relevant community-level data to supplement the national data and drew on local planning and monitoring studies, such as CSO LTCPs, to illustrate site-specific impacts and common technologies used to control CSOs and SSOs. Municipalities were interviewed to obtain additional data to characterize the volume, frequency, and constituents of CSO and SSO discharges; to identify the types of controls implemented and results achieved; and to quantify the resources spent.

3.2.4 Non-Governmental Organization Data Sources

EPA also reviewed reports prepared by non-governmental organizations that contained national-level data relevant to the objectives of this report. These included:

- American Public Works Association (APWA)
- American Society of Civil Engineers (ASCE)
- Association of Metropolitan Sewerage Agencies (AMSA)
- The Ocean Conservancy
- Water Environment Federation (WEF)
- Water Environment Research Foundation (WERF)

3.3 What Data Were Collected?

Data collection involved identification and compilation of existing information. The primary data sources for this report were federal databases and reports as well as interviews with states and municipalities. In addition, EPA performed a comprehensive literature search and applied national assessment models, where appropriate.

In compliance with the Paperwork Reduction Act, EPA prepared and submitted Information Collection Request 2063.01, which was approved by OMB on September 16, 2002 (OMB No. 2040-0248).

The following sections describe data collection and the key assessments carried out by EPA.

3.3.1 Characterization of CSOs and SSOs

This report characterizes CSOs and SSOs by addressing the following key questions:

- *What pollutants are in CSOs and SSOs?*
- *What factors influence the concentrations of these pollutants in CSOs and SSOs?*
- *What other point and nonpoint sources might discharge these pollutants to waterbodies receiving CSOs and SSOs?*
- *What is the universe of combined sewer systems?*
- *What are the characteristics of CSOs?*

- *What is the universe of sanitary sewer systems?*
- *What are the characteristics of SSOs?*
- *How do the volumes and loads from CSOs and SSOs compare to those from other municipal point sources?*

To address these questions EPA used NPDES permit files, state databases for tracking CSO and SSO events, and interviews with state and municipal officials. Specific efforts included updating data on the location of CSSs and CSO outfalls from the 2001 *Report to Congress—Implementation and Enforcement of the Combined Sewer Overflow Control Policy* (EPA 2001a), and compiling SSO volume, frequency, and cause data. This allowed assessment of:

- Pollutants found in CSOs and SSOs
- Location of CSSs and individual CSO outfalls
- Volume and frequency of CSOs and SSOs
- Causes of SSOs
- Comparison of pollutant loads from CSOs and SSOs with other municipal point sources

EPA relied on existing Agency data systems wherever possible. These include PCS, the CWNS, and NWQI. EPA data systems were the principal source of information used to locate CSSs, CSO outfalls, and SSSs. Data on the concentration of pollutants found in CSO and SSO discharges were developed from a number of sources, including engineering and scientific literature, EPA studies,

municipal reports including CSO LTCPs, and interviews with municipal sewer system owners and operators. EPA applied the GPRACSO model to calculate the annual volume of CSOs. Documentation of the GPRACSO model is included as Appendix E of this report. EPA used statistical techniques to develop national estimates of the frequency and volume of SSOs based on data reported electronically by states. Documentation of the statistical techniques is included in this report as Appendix G.

3.3.2 Extent of Environmental Impacts Caused by CSOs and SSOs

This report's analysis of the extent of environmental impacts caused by CSOs and SSOs addresses the following key questions:

- *What is EPA's framework for evaluating environmental impacts?*
- *What overall water quality impacts have been attributed to CSO and SSO discharges in national assessments?*
- *What impacts on specific designated uses have been attributed to CSO and SSO discharges in national assessments?*
- *What overall water quality impacts have been attributed to CSO and SSO discharges in state and local assessments?*
- *What impacts on specific designated uses have been attributed to CSO and SSO discharges in state and local assessments?*

- *What factors affect the extent of environmental impacts caused by CSOs and SSOs?*

EPA used federal reports and data as the primary bases for reporting on environmental impacts from CSOs and SSOs on a national level. The assessment included identification of water quality impairments and environmental impacts associated with CSOs and SSOs with respect to:

- Impaired stream segments
- Impaired lakes
- Impaired estuaries
- Impaired ocean shoreline
- Impaired Great Lakes shoreline
- Beach closures
- Shellfish bed closures

EPA also reviewed national resource assessments from NOAA and non-governmental organizations such as the Ocean Conservancy.

CSS location and individual CSO outfall information published in the 2001 *Report to Congress—Implementation and Enforcement of the Combined Sewer Overflow Control Policy* was updated for this Report to Congress by contacting states and EPA regions to confirm active CSO permit data. The data system developed as part of the 2001 report effort contains latitude and longitude information for over 90 percent of the CSO outfalls currently permitted under the NPDES program. Having the latitude and longitude of the CSO outfalls allowed individual permitted outfalls to be associated with specific waterbody segments (called “reaches”) within

the National Hydrography Dataset (NHD). The NHD is a comprehensive set of digital spatial data of surface water features that enables analysis of water-related data in upstream and downstream order. Associating CSO outfall locations with the NHD-indexed assessed waters allowed for comparison of the outfalls to known impairments reported by states, as required under Clean Water Act Sections 303(d) and 305(b), and to the location of protected resources and sensitive areas. Additional detail on the CSO analysis using the NHD-indexed assessed waters is documented in Appendix F.

SSOs are generally considered unpermitted discharges, and SSO locations are not typically included in NPDES permits. As described in Chapter 4, SSOs occur for a variety of reasons and at many locations within the sewer system, including manholes, roadways, and pump stations. Further, some SSOs discharge to land and not to waters of the United States. For these reasons, it was not possible to conduct a parallel analysis for SSOs using the NHD. EPA, however, did develop a simple model for estimating the likely impact of SSO events on streams and rivers based on reasonable assumptions about SSO event duration, pollutant concentrations, and waterbody characteristics. Additional detail on the model is provided in Appendix H.

National level assessments are unable to convey the circumstances that surround an individual CSO or SSO event, the nature of site-specific environmental impacts, and the consequences with respect to water

quality criteria and designated uses. To account for these localized impacts, EPA used state and community-level data to document site-specific environmental impacts including water quality standards violations, shellfish bed closures, and fish kills. These examples are not comprehensive but are presented to illustrate the potential of CSOs and SSOs to cause or contribute to impacts and impairments.

3.3.3 Extent of Human Health Impacts Caused by CSOs and SSOs

This report's analysis of the extent of human health impacts caused by CSOs and SSOs addresses the following key questions:

- *What pollutants are present in CSOs and SSOs that can cause human health impacts?*
- *What exposure pathways and reported human health impacts are associated with CSOs and SSOs?*
- *Which demographic groups face the greatest risk of exposure to CSOs and SSOs?*
- *Which populations face the greatest risk of illness from exposure to the pollutants present in CSOs and SSOs?*
- *How are human health impacts from CSOs and SSOs prevented, communicated, and mitigated?*
- *What factors contribute to information gaps in identifying and tracking human health impacts from CSOs and SSOs?*



Water quality data from state 305(b) reports were used in gathering information on the environmental impacts of CSOs.

Photo: P. Macneill

- *What new assessment and investigative activities are underway?*

EPA began its effort to document human health impacts from CSOs and SSOs with a literature review. EPA searched on-line databases including PubMed, Toxline, LexisNexis, and the Washington Research Libraries Consortium for relevant reports and articles. A series of waterborne disease outbreak case studies developed from published literature is provided in Appendix I. EPA gathered data on the general incidence and characteristics of waterborne diseases as well as on other impacts associated with the pollutants found in CSO or SSO discharges. The primary source of data on the incidence of waterborne disease in the United States is a joint surveillance system operated by the CDC, EPA, and the Council of State and Territorial Epidemiologists (CDC 2002). Summaries of data collected by CDC are published periodically and divided into waterborne-disease outbreaks resulting from drinking water, recreational waters, or, in some cases, cruise ships. EPA also reviewed reports from non-governmental organizations for data related to human health impacts.

EPA identified experts in the fields of epidemiology, public health policy, and waterborne disease research and invited them to attend a workshop in August 2002. Experts represented EPA, CDC, local health departments, and academia. This workshop did not constitute an advisory committee under the Federal Advisory Committees Act. Rather, it solicited individual expert opinions and provided a forum for information

exchange related to this Report to Congress. EPA shared the results of its initial data collection at this workshop, received feedback on and refined the study methodology, and sought to ensure that gaps and redundancies in the research effort did not exist. An abstract of this workshop is provided in Appendix B; the summary of this workshop was published separately (EPA 2002b).

EPA also estimated the illness burden resulting from exposure to CSOs and SSOs at beaches recognized by state authorities using data from the BEACH Program's annual survey (BEACH Survey) and other sources. EPA analyzed data from responses to the 1999-2002 BEACH Surveys including the number of CSO and SSO events, number of swimmers, bacterial concentrations, and CSO and SSO event duration. An illness rate derived by Cabelli et al. (1983) and Dufour (EPA 1984a) was applied to estimate the number of swimmers who contract gastrointestinal illnesses. Additional details describing this methodology are included in Appendix J.

EPA also conducted interviews with public health personnel, including state or territorial epidemiologists and local public health officials. States and communities were selected from each EPA region in an attempt to ensure geographic, climatic, and population variability among communities interviewed. Nevertheless, the sample is intentionally biased, targeting communities that were likely to have health data related to CSOs and SSOs, or that employed noteworthy water quality monitoring or waterborne

disease outbreak tracking techniques. The results of the interviews are provided in Appendix I.

3.3.4 Evaluation of Technologies Used by Municipalities to Address Impacts Caused by CSOs and SSOs

This report's evaluation of the technologies used by municipalities to address impacts caused by CSOs and SSOs addresses the following key questions:

- *What technologies are commonly used to address CSOs and SSOs?*
- *How do CSO and SSO controls differ?*
- *What are effective technology combinations?*
- *What are emerging technologies for CSO and SSO control?*

EPA conducted a literature review and collected reports on CSO and SSO abatement efforts to evaluate technologies used by municipalities to address the impacts of CSO and SSO discharges. These data included existing EPA fact sheets, technical reports covering relevant research, and wet weather demonstration studies. EPA also reviewed technical guidance manuals developed by states, as well as documentation of local programs, including CSO LTCs. The literature review was supplemented with discussions of CSO and SSO programs in interviews with municipal sewer system owners and operators.

The analysis conducted by EPA included:

- Development of 23 technology descriptions, included as Appendix L of this report, that summarize available technologies and the factors that influence their applicability and effectiveness.
- Identification of common and promising technologies used by municipalities to control CSOs and SSOs.

EPA and non-EPA experts were called upon to provide peer review of technology descriptions, costs, and performance. It is anticipated that technology data gathered and presented in this report's technology descriptions will support development of the technology clearinghouse required by the Wet Weather Water Quality Act of 2000 (P.L.106-554).

3.3.5 Assessment of Resources Spent by Municipalities to Address Impacts Caused by CSOs and SSOs

This report's assessment of resources spent by municipalities to address impacts caused by CSOs and SSOs addresses the following key questions:

- *What federal framework exists for evaluating resources spent on CSO and SSO control?*
- *What are the past investments in wastewater infrastructure?*
- *What has been spent to control CSOs?*
- *What has been spent to control SSOs?*
- *What does it cost to maintain sewer systems?*

- What are the projected costs to reduce CSOs?
- What are the projected costs to reduce SSOs?
- What mechanisms are available for funding CSO and SSO control?

EPA used several of its own reports and reviewed data from other federal agencies (e.g., CBO, GAO, and Census Bureau), states, and non-governmental organizations to assess the national investment in wastewater infrastructure and future needs. EPA also reviewed data collected for the 2000 CWNS (EPA 2003b). EPA used a variety of reports to quantify the resources spent by municipalities to control CSOs and SSOs, including:

- EPA's 1996 *Clean Water Needs Survey* (EPA 1997a) and 2000 CWNS (EPA 2003b)
- EPA's *Clean Water and Drinking Water Infrastructure Gap Analysis* (EPA 2002a)
- Clean Water State Revolving Fund (CWSRF) records
- Negotiated enforcement actions
- Interviews with municipal owners and operators of sewer systems
- CSO LTCPs
- Recent AMSA, ASCE, and WERF reports

EPA also used a variety of sources to assess available mechanisms for funding CSO and SSO control, including:

- EPA's *Clean Water and Drinking Water Infrastructure Gap Analysis* (EPA 2002a)

- EPA's 2001 *Report to Congress—Implementation and Enforcement of the Combined Sewer Overflow Control Policy* (EPA 2001a)
- EPA's Fact Sheet: *Financing Capital Improvements for SSO Abatement* (EPA 2001c)
- EPA's *Combined Sewer Overflows: Guidance for Funding Options* (EPA 1995a)
- GAO reports
- CSO LTCPs

3.4 How Were Stakeholders Involved in the Preparation of this Report?

EPA consulted and worked with a broad group of stakeholders for this report. EPA conducted site visits to several EPA regions and six states; developed a series of 23 technology descriptions in cooperation with municipalities; and sought review of sections of the report from experts internal and external to EPA. States and municipalities featured in this Report to Congress were provided the opportunity to review information specifically pertaining to them.

Throughout 2002 and 2003, EPA met with representatives from key stakeholder groups such as AMSA, NRDC, and WEF. During these meetings, EPA presented an overview of the congressional directive and the Agency's planned response. EPA then solicited feedback on its progress. The comments and suggestions of the stakeholder groups were incorporated into the preparation of this report.



In 1999, North Bergen Municipal Utilities installed numerous mechanical screen bars and netting systems to control solids and floatables in CSOs. The facilities cost \$3.3 million and annually cost \$57,373 to operate and maintain (2002 dollars).

Photo: NJDEP

As described in Section 3.3.3, EPA facilitated a workshop for public health experts in Arlington, Virginia. Experts represented EPA, CDC, local health departments, and academia. Observers of the workshop included representatives of many stakeholder groups.

EPA also sponsored stakeholder meetings during development of this report in Washington, DC (June 2003), and in Huntington Beach, CA (July 2003). Participants included representatives from EPA regions; states; municipal sewer system owners, operators, and consultants; national and local environmental organizations; professional associations; and public health experts. The purpose of these meetings was to:

- Provide a preliminary description of the report methodology and findings
- Discuss the implications of preliminary findings
- Describe data availability and limitations
- Solicit additional data on impacts, costs, and technologies

EPA presented preliminary data on all aspects of the report, received comments on data sources and data interpretation, and received input on the context within which these findings should be viewed. A summary of the stakeholder meetings is provided in Appendix B of this report. EPA also made presentations at numerous national meetings and conferences to provide progress reports and updates to stakeholders.

3.5 What Data Considerations Are Important?

The information collection strategy used to support this report includes several important data considerations. First and foremost, EPA based this report on the collection, compilation, and analysis of existing data and program information. No surveys or field monitoring were conducted to quantify pollutant concentrations or environmental and human health impacts. Similarly, EPA did not undertake new research or analysis in the assessment of technologies or evaluation of costs.

Another important data consideration is state-to-state differences in the definition of “CSO event” and “SSO event” related to threshold volumes and duration of events that last beyond midnight or for more than 24 hours. EPA also found that wastewater backups into buildings, including private residences, are not typically tracked by or reported to NPDES authorities.

A third consideration is that often the pollutants present in CSOs and SSOs have numerous sources within a given watershed. These sources include municipal wastewater treatment plants, storm water runoff, decentralized wastewater treatment systems, runoff from agricultural areas, and wildlife and domesticated animals. It can be difficult, if not impossible, to differentiate environmental and human health impacts caused by CSO and SSO discharges from those caused by these other sources.

A fourth consideration is the potential underreporting of waterborne disease outbreaks. Existing systems for tracking these outbreaks often lack sufficient information on the cause of the outbreak to establish whether CSOs or SSOs are a suspected source.

A final data consideration is that the nature of many CSO and SSO control activities makes it difficult to separate their costs from routine municipal wastewater infrastructure expenditures. Further, local and state governments currently fund the majority of wastewater infrastructure costs. Mechanisms for compiling comprehensive national level information on expenditures on CSO and SSO control do not exist. The CWSRF is the most comprehensive source of information on state and local spending on wastewater projects. There are, however, several important limitations to using data from the CWSRF. First, operation and maintenance (O&M) costs are not reported. Second, many CSO communities do not participate in the CWSRF. Third, the CWSRF has no separate accounting categories for SSO control. Moreover, although many communities and states are making concerted efforts to report additional needs for CSO and SSO control, very few report the cost of implementing technologies.

Although the above considerations shaped the approach used to develop this report, the basic objectives—to respond to Congress with an accurate characterization of the volume, frequency, and location of CSOs and SSOs; the extent of human health and environmental impacts caused by

CSOs and SSOs; the resources spent by municipalities to address these impacts; and the technologies used to address impacts—never varied.

3.6 What Quality Control and Quality Assurance Protocols Were Used?

EPA applied a detailed data verification and interpretation process following data collection. Federal and state data sets were evaluated for missing and inconsistent data. Follow-up phone calls were made to data providers to verify the accuracy and completeness of EPA's records. Likewise, site-specific examples of impacts and technology application were reviewed by local officials.

The data taken from reports prepared by external sources, such as ASCE and AMSA, were not obtained directly by EPA and were used as reported. These data were not subjected to the same quality control as data collected and compiled directly by EPA.

3.7 Summary

Chapters 4 through 9 provide a detailed assessment of the data and materials collected in support of this Report to Congress. The compilation of existing data led to development of several new analyses that previously did not exist. These include:

- National estimates of the frequency and volume of SSOs
- Analysis of causes of SSOs

- National modeling of SSO events to estimate violations of water quality standards
- Updated CSO permit information with latitude and longitude for over 90 percent of CSO outfalls
- Analysis linking CSO outfall locations with impaired waters and sensitive areas through the NHD
- Modeling to estimate the number of gastrointestinal illnesses resulting from exposure to CSOs and SSOs at BEACH Survey beaches

Chapter 4

Characterization of CSOs and SSOs

Consistent with the congressional directive, this chapter provides a comprehensive description of CSOs and SSOs with respect to the location of discharges, the frequency and volume of discharges, and the constituents discharged. Similarities and differences in the character of CSO and SSO discharges are noted where they occur. Comparisons of CSOs and SSOs to other sources of pollution have been made where appropriate. The CSO and SSO characterization information provided in this chapter is important for assessing the environmental and human health impacts of CSOs and SSOs.

For purposes of this Report to Congress, the terms “wet weather” and “dry weather” are used to distinguish sewer overflows that are rainfall- or snowmelt-induced from those that are not caused by rainfall or snowmelt. The discussion of CSOs in this report is limited to wet weather CSOs. That

is, those CSOs that are rainfall- or snowmelt-induced and occur at permitted CSO outfalls. Dry weather CSO discharges are prohibited under the NPDES program.

SSOs can be induced by rainfall or snowmelt when excess I/I causes the conveyance capacity of the SSS to be exceeded. SSOs also occur as a result of other, non-wet weather causes such as blockages, line breaks, vandalism, mechanical failures, and power failure. The terms “wet weather SSOs” and “dry weather SSOs” are used in this report to differentiate these two general types of SSOs because these events have different characteristics and respond to different control strategies. The discussion of SSOs in this report, including national estimates of volume and frequency, does not account for wet weather or dry weather discharges occurring after the headworks of the treatment plant, regardless of the level of treatment, or backups into buildings caused by problems in the publicly-owned portion of the SSS.

In this chapter:

- 4.1 What Pollutants are in CSOs and SSOs?

- 4.2 What Factors Influence the Concentrations of the Pollutants in CSOs and SSOs?

- 4.3 What Other Point and Nonpoint Sources Might Discharge These Pollutants to Waterbodies Receiving CSOs and SSOs?

- 4.4 What is the Universe of CSSs?

- 4.5 What are the Characteristics of CSOs?

- 4.6 What is the Universe of SSSs?

- 4.7 What are the Characteristics of SSOs?

- 4.8 How Do the Volumes and Pollutant Loads from CSOs and SSOs Compare to Those from Other Municipal Point Sources?

4.1 What Pollutants are in CSOs and SSOs?

The principal pollutants present in CSO and SSO discharges include:

- Microbial pathogens
- Oxygen depleting substances (measured as BOD₅)
- TSS
- Toxics
- Nutrients
- Floatables

The pollutants in CSOs and SSOs come from a variety of sources.

Domestic wastewater contains microbial pathogens, BOD₅, TSS, and nutrients. Wastewater from industrial facilities, commercial establishments, and institutions can contribute additional pollutants such as fats, oils, and grease (FOG), and toxic substances including metals and synthetic organic compounds. Fungi do not have a major presence in wastewater (WERF 2003b). Storm water can also contribute pollutants to CSSs and, in some instances, SSSs. The concentration of pollutants in storm water is generally more dilute than in wastewater, but can contain significant amounts of microbial pathogens, BOD₅, TSS, toxics (notably metals and pesticides), nutrients, and floatables. Pollutant concentrations in CSOs and SSOs vary substantially, not only from community to community and event to event, but also within a given event.

Descriptions of the pollutants in CSOs and SSOs are provided in the following subsections and include comparisons of concentration data for discharges

from different municipal sources. The comparisons include, where available, median pollutant concentrations and ranges of concentrations found in treated wastewater, untreated wastewater, CSOs, wet weather SSOs, dry weather SSOs, and urban storm water. The origin and relative availability of data on pollutant concentrations in discharges were not consistent for the different municipal sources. In general, adequate data were available to characterize treated and untreated wastewater, CSOs, and urban storm water. Monitoring data to characterize actual wet and dry weather SSO discharges, however, were less readily available.

EPA compiled a limited dataset on pollutant concentrations in wet weather SSOs as part of municipal interviews conducted for this Report to Congress. EPA also identified a study conducted by the Wisconsin Department of Natural Resources that quantified the concentration of various constituents in wet weather SSOs from a number of federal and locally-sponsored studies (WDNR 2001). The findings of the WDNR study support the data EPA collected on wet weather SSOs for this Report to Congress. For the purposes of this report, EPA assumed that dry weather SSOs would have the same characteristics and pollutant concentrations as untreated wastewater.

The descriptions of pollutants in CSOs and SSOs include an overview of the types of impacts typically associated with these pollutants. The presence of pollutants in a CSO or SSO discharge in and of itself is not indicative of

environmental or human health impacts. The occurrence of actual impacts depends on the concentration of the pollutant present, the volume and duration of the CSO or SSO event, the location of the discharge, the condition of the receiving water at the time of the discharge, and, in the case of human health, exposure. More detailed discussions of environmental and human health impacts of CSOs and SSOs are presented in Chapters 5 and 6, respectively.

4.1.1 Microbial Pathogens

Microbial pathogens are microorganisms that can cause disease in aquatic biota and illness or even death in humans. The three major categories of microbial pathogens present in CSOs and SSOs are bacteria, viruses, and parasites. These microbial pathogens are, for the most part, easily transported by water. A brief discussion of these pathogens, including the concentrations present in various municipal discharges, is presented below. A more detailed discussion of pathogens is presented in Chapter 6 of this report.

Bacteria

The two broad categories of bacteria associated with wastewater are indicator bacteria and pathogenic bacteria. Indicator bacteria are widely used as a surrogate for microbial pathogens in wastewater and water quality assessments. Indicator bacteria suggest the presence of disease-causing organisms, but generally are not pathogenic themselves. The principal indicator bacteria used to assess water quality are fecal coliform, *E. coli*, and enterococcus. All three are found in the intestines and feces of warm-blooded animals.

Fecal coliform concentrations from municipal sources are presented in Table 4.1. As shown, concentrations of fecal coliform found in CSOs and wet weather SSOs are generally less than the concentrations found in untreated wastewater and dry weather SSOs, and greater than the concentrations reported for urban storm water.

Pathogenic bacteria are capable of causing disease. Examples of pathogenic bacteria associated with untreated wastewater, CSOs, and SSOs

Table 4.1

Fecal Coliform Concentrations in Municipal Discharges

The presence of fecal coliform bacteria in aquatic environments indicates that the water has been contaminated with fecal material of humans or other warm-blooded animals.

Municipal Sources	Fecal Coliform (colonies/100 ml)		
	Number of Samples	Range	Median
Untreated wastewater/dry weather SSOs	--	1,000,000 ^a - 1,000,000,000 ^d	--
Wet weather SSOs ^a	--	--	500,000
CSOs ^b	603	3 - 40,000,000	215,000
Urban storm water ^c	1,707	1 - 5,230,000	5,081
Treated wastewater	--	--	<200 ^e

^a WDNR 2001

^b Data collected as part of municipal interviews

^c Pitt et al. 2003

^d NRC 1996

^e Limit for disinfected wastewater

include *Campylobacter*, *Salmonella*, *Shigella*, *Vibrio cholerae*, and *Yersina*.

Viruses

More than 120 enteric (intestinal) viruses may be found in sewage (NAS 1993). Concentrations of viruses reported in wastewater vary greatly and depend on the presence and amount of infection in the population served by a sewer system, season of the year, and the methods used for enumerating the virus counts. Examples of viruses associated with untreated wastewater, CSOs, and SSOs include poliovirus, infectious hepatitis virus, and coxsackie virus.

Parasites

The common parasites of human health concern in untreated wastewater are parasitic protozoa and helminths (NAS 1993). Parasitic protozoa include *Giardia*, *Cryptosporidium*, and *Entamoeba*. *Giardia* is the most common protozoan infection in the United States (NAS 1993). *Giardia* has been detected in treated and untreated wastewater at levels of 0.0002 to 0.011 cysts per L and 2 to 200,000 cysts per L, respectively (Payment and Franco 1993; Yates 1994; NAS 1998; Rose et al. 2001b). *Cryptosporidium* has also been detected in treated and untreated wastewater at concentrations of 0.0002 to 0.042 oocysts per L and less than 0.3 to 13,700 oocysts per L, respectively (Payment and Franco 1993; NAS 1998; Rose et al. 2001a; McCurin and Clancy 2004).

Several recent studies have specifically investigated the presence of

Cryptosporidium and *Giardia* in CSOs. *Giardia* concentrations ranging from 2 to 225 cysts per L were measured in samples collected during two overflow events at each of the six CSO outfalls (EPA 2003f). A study conducted in Pittsburgh also found *Cryptosporidium* (0 to 30 oocysts per L) and *Giardia* (37.5 to 1,140 cysts per L) in CSOs (States et al. 1997). Given that both CSOs and SSOs include untreated wastewater, this suggests that CSOs and SSOs are also likely to contain significant concentrations of *Giardia*, and possibly *Cryptosporidium*.

Helminths include roundworms, hookworms, tapeworms, and whipworms. These organisms are endemic in areas lacking adequate access to hygiene facilities, including toilets. Their transmission is generally associated with untreated sewage and sewage sludge. However, there is very little documentation of waterborne transmission of helminths (NAS 1993).

4.1.2 BOD₅

BOD₅ is widely used as a measure of the amount of oxygen-demanding organic matter in water or wastewater. The organic matter in sewage is a mix of human excreta, kitchen waste, industrial waste, and other substances discharged into sewer systems. When significant amounts of BOD₅ are discharged to a waterbody, the dissolved oxygen can be depleted. This occurs principally through the decay of organic matter and the uptake of oxygen by bacteria. The depletion of dissolved oxygen in waterbodies can be harmful or fatal to aquatic life. Low levels of dissolved oxygen are responsible for many of the fish

Table 4.2

BOD₅ Concentrations in Municipal Discharges

The consequences of high BOD₅ concentrations are the same as those for low dissolved oxygen: aquatic organisms become stressed, suffocate, and die.

Municipal Sources	Number of Samples	BOD ₅ (mg/l)	
		Range	Median
Untreated wastewater/dry weather SSOs ^a	--	88 - 451	--
Wet weather SSOs ^b	22	6 - 413	42
CSOs ^b	501	3.9 - 696	43
Urban storm water ^c	3,110	0.4 - 370	8.6
Treated wastewater ^d	--	--	30

^a AMSA 2003a. 85 facilities reported annual average BOD₅ concentration data; each facility based its value on an unspecified amount of monitoring

^b Data collected as part of municipal interviews

^c Pitt et al. 2003

^d Typical limit for wastewater receiving secondary treatment

kills reported and tracked by resource agencies. BOD₅ concentrations from municipal sources are presented in Table 4.2. As shown, the median concentrations of BOD₅ in CSOs and wet weather SSOs are typically five times greater than concentrations found in urban stormwater. Median BOD₅ concentrations in CSOs and wet weather SSOs are typically 1.3 to 1.4 times greater than concentrations found in treated wastewater.

4.1.3 TSS

TSS is a measure of the small particles of solid pollutants that float on the surface of, or are suspended in, water or wastewater. TSS in wastewater includes a wide variety of material,

such as decaying plant and animal matter, industrial wastes, and silt. High concentrations of TSS can cause problems for stream health and aquatic life. TSS can clog fish gills, reduce growth rates, decrease resistance to disease, and impair reproduction and larval development. The deposition of solids can damage habitat by filling spaces between rocks that provide shelter to aquatic organisms. TSS can accumulate in the immediate area of CSO and recurrent SSO discharges, creating turbid conditions that smother the eggs of fish and aquatic insects. TSS concentrations from municipal sources are presented in Table 4.3. As shown, the median concentration of TSS in CSOs and wet weather SSOs is

Table 4.3

TSS Concentrations in Municipal Discharges

Over the long-term, the deposition of solids in the immediate area of CSO and SSO discharges can damage aquatic life habitat.

Municipal Sources	Number of Samples	TSS (mg/l)	
		Range	Median
Untreated wastewater/dry weather SSOs ^a	--	118 - 487	--
Wet weather SSOs ^b	27	10 - 348	91
CSOs ^b	995	1 - 4,420	127
Urban storm water ^c	3,396	0.5 - 4,800	58
Treated wastewater ^d	--	--	30

^a AMSA 2003a. 121 facilities reported annual average TSS concentration data; each facility based its value on an unspecified amount of monitoring

^b Data collected as part of municipal interviews

^c Pitt et al. 2003

^d Typical limit for wastewater receiving secondary treatment

higher than concentrations in urban storm water.

4.1.4 Toxics

Toxics are chemicals or chemical mixtures that, under certain circumstances of exposure, present an environmental or human health risk. Toxics include metals, hydrocarbons, and synthetic organic chemicals. Concentrations of toxics in wastewater can be a concern in industrialized areas or where monitoring data

indicate potential toxicity (Moffa 1997). Storm water contributions to CSOs in urbanized areas can also contain significant concentrations of hydrocarbons and metals. Metals concentrations from municipal sources are presented in Tables 4.4 and 4.5.

In general, environmental problems related to toxicity fall into two categories: chronic or long-term exposure to toxics causing reduced growth and reproduction, and acute

Table 4.4

Cadmium and Copper Concentrations in Municipal Discharges

For many municipalities, the largest source of copper in wastewater is corrosion of copper pipes (PARWQCP 1999). Other sources include industrial discharges, copper-based root killers, and cooling water discharges.

Municipal Sources	Cadmium (µg/l)			Copper (µg/l)		
	Number of Samples	Range	Median	Number of Samples	Range	Median
Untreated wastewater/dry weather SSOs ^a	--	0.1 - 101	--	--	1.8 - 322	--
Wet weather SSOs	--	--	--	--	--	--
CSOs ^b	401	0.16 - 30	2	346	10-1,827	40
Urban storm water ^c	2,582	0.04 - 16,000	1	2,728	0.6 - 1,360	16
Treated wastewater ^d	465	0.01 - 3.0	0.04	596	2.8-16.0	5.2

^a AMSA 2003a. 101 and 109 facilities reported annual average Cd and Cu concentrations, respectively; each facility based its value on an unspecified amount of monitoring

^b Data collected as part of municipal interviews

^c Pitt et al. 2003

^d WERF 2000

Table 4.5

Lead and Zinc Concentrations in Municipal Discharges

Municipal wastewater treatment facilities are reported to be the largest point source for zinc discharges to surface waters (WSDOH 1996).

Municipal Sources	Lead (µg/l)			Zinc (µg/l)		
	Number of Samples	Range	Median	Number of Samples	Range	Median
Untreated wastewater/dry weather SSOs ^a	--	0.5 - 250	--	--	9.7 - 1,850	--
Wet weather SSOs	--	--	--	--	--	159
CSOs ^b	438	5 - 1,013	48	442	10 - 3,740	156
Urban storm water ^c	2,954	0.2 - 1200	16	3,016	0.1 - 22,500	117
Treated wastewater ^d	21	0.2 - 1.4	0.6	530	20.0 - 57.5	51.9

^a AMSA 2003a. 106 and 109 facilities reported annual average Pb and Zn concentrations, respectively; each facility based its value on an unspecified amount of monitoring

^b Data collected as part of municipal interviews

^c Pitt et al. 2003

^d WERF 2000

or short-term exposure at higher concentrations causing increased mortality. Chronic effects are subtle and difficult to identify, but can be observed by lower productivity and biomass (numbers of organisms), bioaccumulation of chemicals, or reduced biological diversity. Acute effects can be observed as immediate fish kills or severely reduced biologic diversity.

4.1.5 Nutrients

Nutrients is the term generally applied to nitrogen and phosphorus. Untreated wastewater contains significant amounts of nitrogen and phosphorus from domestic and industrial sources. CSSs also receive nutrients contained in urban runoff from street litter and chemical fertilizers applied to landscaped areas, lawns, and gardens. Nutrients are essential to the growth of plants and animals. Excess amounts of nitrogen and phosphorus can cause rapid growth of algae and nuisance plants, as well as eutrophic conditions that can lead to oxygen depletion.

Total phosphorus and total kjeldahl nitrogen (a measure of ammonia and organic nitrogen) concentrations from municipal sources are presented in Table 4.6. As shown for total phosphorus, wet weather SSO concentrations are roughly equivalent to treated wastewater concentrations and are approximately one-third of untreated wastewater concentrations. Total phosphorus concentrations in CSO and urban stormwater are generally less than those in wet weather SSOs.

4.1.6 Floatables

Floatables is the term used to describe the trash, debris, and other visible material discharged when sewers overflow. In SSSs, floatables generally include sanitary products and other wastes commonly flushed down a toilet. In CSSs, floatables include litter and detritus that accumulate on streets and other paved areas that wash into CSSs during rainfall or snowmelt events. Floatables can have an adverse impact on wildlife, primarily through entanglement or ingestion. Floatables

Municipal Sources	Total Phosphorus (mg/l)			Total Kjeldahl Nitrogen (mg/l)		
	Number of Samples	Range	Median	Number of Samples	Range	Median
Untreated wastewater/dry weather SSOs ^a	--	1.3 - 15.7	5.8	59	11.4 - 61	33
Wet weather SSOs ^b	--	--	2	--	--	--
CSOs ^c	43	0.1 - 20.8	0.7	373	0 - 82.1	3.6
Urban storm water ^d	3,283	0.01 - 15.4	0.27	3,199	0.05 - 66.4	1.4
Treated wastewater ^a	72	0.07 - 6	1.65	64	0.5 - 32	3.95

^a AMSA 2003a. 59 facilities reported annual average total P and TKN concentrations; each facility based its value on an unspecified amount of monitoring

^b WDNR 2001

^c Data collected as part of municipal interviews

^d Pitt et al. 2003

Table 4.6

Nutrient Concentrations in Municipal Discharges

Nutrient additions can cause increased algae or aquatic weed growth that, in turn, can deplete dissolved oxygen, reduce biologic diversity, worsen aesthetics, and impair use for water supply (Moffa 1997).

can also contribute to aesthetic impacts in recreation areas.

An extensive monitoring program conducted in New York City suggests that more than 90 percent of floatables in the city's CSOs originate as street litter (NYCDEP 1997). The monitoring program specifically found that street trash, including plastics, polystyrene, and paper, accounted for approximately 93 percent of the floatables discharged. Personal hygiene items and medical materials accounted for approximately one percent of all floatables discharged into New York Harbor through CSOs. The remaining six percent of floatable items included glass, metal, wood, and cloth.

4.2 What Factors Influence the Concentrations of the Pollutants in CSOs and SSOs?

The pollutant concentrations associated with CSO and SSO discharges are highly variable. Pollutant concentrations vary not only from site to site and event to event, but also within a given overflow event. Brief descriptions of some of the factors that influence pollutant concentrations in CSOs and SSOs are described in the following subsections.

4.2.1 Factors Influencing Pollutant Concentrations in CSOs

The relative amounts of domestic, commercial, and industrial wastewater, and urban storm water carried by a CSS during specific wet weather events are the primary driver of pollutant concentrations in CSOs. Other factors

that contribute to the variability include:

- Elapsed time since the wet weather event began, with higher pollutant concentrations expected during the early stages of a CSO event (often termed the “first flush”);
- Time between the current and most recent wet weather events, with higher pollutant concentrations expected in CSOs occurring after lengthier dry periods; and
- Intensity and duration of the wet weather event.

The sudden rush of flow into a CSS brought on by rainfall, or in some instances, snowmelt, can create a first flush effect. The first flush effect occurs when pollutants washed from city streets and parking lots combine with pollutants re-suspended from settled deposits within the CSS. This combination can produce peak pollutant concentrations at the beginning of the CSO event, particularly if rainfall is intense. First flush effects are typically observed during the first 30 to 60 minutes of a CSO discharge (Moffa 1997). They are generally more pronounced after an extended dry period and in sewer systems with low gradients (slope). Many CSO control programs have been designed specifically to capture the first flush.

4.2.2 Factors Influencing Pollutant Concentrations in SSOs

Wastewater flows generated by domestic, commercial, and industrial sources fluctuate on diurnal, weekend/weekday, and seasonal cycles. Periods

of low and high flows are associated with water demand and use. SSSs carry varying amounts of I/I during wet weather periods, when the ground is saturated, and when the water table is elevated. The amount of I/I entering an SSS is influenced by:

- Age and condition of SSS components
- Local use of SSS for roof and foundation drainage
- Location of sewer pipes relative to the water table
- Characteristics of recent rainfall events
- Soil type and antecedent soil moisture conditions

The amount of I/I, in turn, influences the concentration of pollutants in SSO discharges.

Dry weather SSOs consist mainly of domestic, commercial, and industrial wastewater, with limited amounts of I/I. Therefore, the pollutant concentrations in dry weather SSOs are most heavily influenced by the relative contribution from domestic, commercial, and industrial customers to the total flow.

4.3 What Other Point and Nonpoint Sources Might Discharge These Pollutants to Waterbodies Receiving CSOs and SSOs?

CSOs and SSOs contribute to pollutant loadings where discharges occur. Waterbodies also receive pollutants of the types found in CSOs and SSOs from other point and nonpoint sources including:

- Wastewater treatment facilities
- Decentralized wastewater treatment systems
- Industrial point sources
- Urban storm water
- Agriculture
- Domestic animals and wildlife
- Commercial and recreational vessels

The contribution of pollutant loads from CSOs and SSOs relative to other point and nonpoint sources varies widely depending on the characteristics of the waterbody and the volume, frequency, and duration of CSO and SSO events. Each of these sources is discussed briefly below.

In 1999, the Augusta Sanitary District completed the first phase of a \$40-million five-phase CSO Long Term Control Plan as part of an Administrative Order (AO). Phase One involved a \$12.2-million upgrade of the wastewater treatment plant to increase the treatment capacity and to better treat excess wet weather flows from the CSS. Prior to the upgrade, excess wet weather flows received minimal treatment (sometimes bypassing primary and secondary treatment processes entirely) and were not disinfected prior to discharge. Since completion of the treatment plant upgrade, the District bypasses secondary treatment processes only during wet weather events, and has the capacity to provide primary treatment, chlorination, and dechlorination to the bypassed flows. Bypassing frequency has decreased by 70 percent.

**CSO-related Bypass at
Wastewater Treatment Facility:
Augusta, ME**



**Wet Weather Bypass at
Wastewater Treatment Facility
Serving SSS:
Jefferson County, AL**



The Village Creek Wastewater Treatment Plant in Jefferson County, Alabama, routinely experienced peak wet weather flows greater than 10 times its annual average flow of 40 mgd. Due to extreme peak wet weather flows in the system, untreated wastewater was frequently diverted from the Village Creek plant and discharged without treatment. Between 1997 and 2001, excess wastewater flow was diverted and discharged an average of 41 times per year. Under a Consent Decree issued in 1996, Jefferson County initiated corrective actions to address diversions of untreated wastewater from the Village Creek facility, as well as other problems within the system. The total cost for the improvements are estimated to approach \$2.5 billion.

4.3.1 Wastewater Treatment Facilities

Wastewater treatment facilities are designed to receive domestic, commercial, and industrial wastewater, and to treat it to the level specified in an NPDES permit. Permits typically define effluent concentration limits for BOD₅ and TSS, and for indicator bacteria (typically fecal coliform, *E. coli*, or enterococci) when disinfection is required. Wastewater treatment facilities that discharge to impaired or sensitive waters may have more stringent effluent limits for BOD₅, TSS, or additional parameters (e.g., additional reduction of nutrients and metals).

Wastewater treatment facilities in the United States are estimated to contribute to the impairment of four percent of the nation's assessed rivers and streams; five percent of the nation's assessed lakes, ponds, and reservoirs; and 19 percent of assessed estuaries (EPA 2002c). The concentrations of fecal coliform, BOD₅, TSS, metals, and nutrients in treated and untreated wastewater can be compared using the tables in Section 4.1 of this report.

Untreated and Partially Treated Discharges from Wastewater Treatment Facilities

In CSSs and to a lesser degree in SSSs, flows to wastewater treatment facilities increase during periods of wet weather. Significant increases in influent flow caused by wet weather conditions (e.g., due to I/I into the sewer system) can create operational challenges for treatment facilities and can adversely affect treatment efficiency, reliability, and control of treatment processes. Excess wet weather flows can result in discharges of untreated or partially treated wastewater at the treatment facility.

Treatment plants are sometimes designed to route peak wet weather flows that exceed capacity around secondary treatment units and then blend them with treated wastewater to meet permit limits. Volumes associated with wet weather discharges can be substantial.

Treatment facilities serving CSSs may be allowed to discharge partially treated wastewater (e.g., wastewater having received primary treatment and disinfection, if necessary) during periods of wet weather, according to

the terms of their permit. Untreated wet weather discharges at treatment facilities serving CSSs are not permitted and are required to be reported to the NPDES authority within 24 hours of their occurrence.

With rare exception, treatment facilities serving SSSs are only permitted to discharge wastewater that has received appropriate treatment. Discharges of untreated wastewater at treatment facilities serving SSSs are required to be reported to the NPDES authority within 24 hours of their occurrence.

4.3.2 Decentralized Wastewater Treatment Systems

Decentralized wastewater treatment systems are on-site or clustered wastewater systems used to treat and dispose of relatively small volumes of wastewater, generally from private residences and businesses that are located in close proximity to each other. These systems serve individual residences as well as trailer parks, recreational vehicle parks, and campgrounds. They are commonly referred to as septic systems, private sewage systems, or individual sewage systems. Some decentralized systems are designed to have a surface discharge. Approximately 25 percent of the total population of the United States is served by decentralized wastewater treatment systems, and about 33 percent of new residential construction employs this type of treatment (EPA 2003g). The 2001 American Housing Survey for the United States reported that approximately 6 percent of decentralized wastewater treatment systems fail annually. Depending

on assumptions about persons per household and water use, these failures may result in improper treatment of 180 to 396 million gallons of wastewater daily, or 66 to 144 billion gallons discharged annually. Failing decentralized wastewater treatment systems can contribute to pathogen and nutrient contamination of surface water and groundwater (Bowers 2001).

4.3.3 Industrial Point Sources

Industrial point sources include non-municipal industrial and commercial facilities that treat and discharge wastewater, with attendant pollutants, directly to receiving waters. Unlike municipal wastewater treatment facilities, the types of raw materials, production processes, and treatment technologies utilized by industrial and commercial facilities vary widely. Consequently, the pollutants discharged by industrial point sources vary considerably and are dependent on specific facility characteristics (EPA 1996b). In addition to wastewater, industrial point sources can also collect and discharge storm water runoff generated at their facility. Industrial point sources are regulated under the NPDES point source and storm water programs. Many discharges are governed by industry-specific effluent guidelines. Industrial point sources can be a major source of pollutants, particularly nutrients and toxics, in waters receiving the discharges.

4.3.4 Urban Storm Water

Urban storm water runoff occurs when rainfall does not infiltrate into the ground or evaporate. Urban storm water runoff flows onto adjacent

land, directly into a waterbody, or is collected and routed through a separate storm sewer system. Urban storm water runoff is principally generated from impervious surfaces such as city streets and sidewalks, parking lots, and rooftops. In general, the degree of urbanization increases the variety and amount of pollutants carried by storm water runoff. Although concentrations of specific pollutants in urban storm water runoff vary widely, the most common pollutants include microbial pathogens from pet and wildlife wastes; TSS; metals, oil, grease, and hydrocarbons from motor vehicles; and nutrients, pesticides, and fertilizers from lawns and gardens (EPA 2003h).

Urban storm water discharges are a leading cause of impairment of the nation's surface waters (EPA 2002c). Storm water is estimated to contribute to the impairment of 5 percent of assessed river miles nationwide, 8 percent of assessed lake acres, and 16 percent of assessed estuarine square miles (EPA 2002). EPA has estimated that approximately 27.6 billion gallons of storm water runoff are generated daily from urbanized areas nationwide (EPA 2002c).

4.3.5 Agriculture

Agriculture is a major source of pollution in the United States and the leading source of impairment in assessed rivers and streams, as well as in assessed lakes, ponds, and reservoirs (EPA 2002c). Agricultural sources that contribute pollutant loads to waterbodies include row crops, pastures, feed lots, and holding pens. Agricultural practices that add

pollution include over-application of manure, other fertilizers, and pesticides; tillage practices that leave the earth exposed to erosion; and pasture and range practices that provide livestock with direct access to waterways. These practices add microbial pathogens, BOD₅, TSS, toxics, and nutrients to runoff from agricultural areas. More than 150 microbial pathogens found in livestock manure are associated with health risks to humans. This includes the microbial pathogens that account for more than 90 percent of food and waterborne diseases in humans (EPA 2003i). These pathogens are *Campylobacter*, *Salmonella* (non-typhoid), *Listeria monocytogenes*, pathogenic *E. coli*, *Cryptosporidium*, and *Giardia*.

4.3.6 Domestic Animals and Wildlife

Although livestock are believed to be the greatest contributor of animal waste to receiving waters, loads from pets, wild birds, and other mammals can be significant (EPA 2001d). This is particularly true in urban areas where there are no livestock, but pets and wildlife are common. In addition, the feces of waterfowl (e.g., geese and ducks) can contribute significant nutrient loads to waterbodies (Manny et al. 1994).

Animal waste associated with pets, wild birds, and small mammals can present significant risk to humans. Between 15 and 50 percent of pets and 10 percent of mice and rats may be infected with *Salmonella* (NAS 1993). In addition, many wildlife species are reservoirs of microorganisms that can be pathogenic to humans. Beaver and

deer are large contributors of *Giardia* and *Cryptosporidium*, respectively (EPA 2001d). Waterfowl such as geese, ducks, and heron can also contaminate surface waters with microbial pathogens (Graczyk et al. 1998).

Bacteria source-tracking can be employed to establish the relative contribution of human and non-human sources to levels of indicator bacteria measured in a given waterbody. For example, watershed studies in the Seattle, Washington area found that nearly 20 percent of bacteria in receiving water samples were traceable to dogs (EPA 2001d). A study of Four Mile Run in Northern Virginia found that waterfowl accounted for 37 percent, humans and dogs together accounted for 26 percent, and raccoons accounted for 15 percent of the bacteria. Deer and rats contributed smaller percentages (NVPDC 2000).

4.3.7 Commercial and Recreational Vessels

Improper disposal of sewage by commercial and recreational vessels can spread disease, contaminate shellfish beds, and lower oxygen levels in receiving waters (CFWS 2003). Improper disposal is also a problem in marinas and harbors, despite the prohibition on the discharge of untreated sewage in the Great Lakes, in all navigable rivers, and within three miles of the U.S. coastline. Improper disposal of sewage occurs largely as a result of inadequate facilities on-board vessels and at docks, and a lack of education about safe handling and disposal of sewage. Boaters often illegally dump or dispose sewage improperly in marina toilets,

overloading them (Baasel-Tillis 1998). Impacts due to pollution from commercial and recreational vessels are highly localized.

4.4 What is the Universe of CSSs?

Most CSSs are located in the Northeast and Great Lakes regions. Thirty-two states (including the District of Columbia) have permitted CSSs in their jurisdiction. As of July 2004, these 32 states had issued 828 active CSO permits to 746 communities. These permits regulate 9,348 CSO discharge points. The distribution of CSO permits and CSO outfalls in each state are shown in Figures 4.1 and 4.2, respectively. About 46 million people are served by CSSs, which include an estimated 140,000 miles of municipally-owned sewers.

CSO permits have been issued to the owners and operators of two types of CSSs:

- CSSs owned and operated by the same entity that owns and operates the receiving POTW; and
- CSSs that convey flows to a POTW owned and operated by a separate entity under a different permit.

Communities that operate and maintain a sewer system but send wastewater flows to a treatment plant owned and operated by another entity are referred to as “satellite systems.” The 828 active CSO permits include 616 combined systems with POTWs, 176 satellite systems, and 36 systems that EPA has been unable to classify due to insufficient data.

Figure 4.1

Distribution of CSO Permits by Region and by State

More than half of the nation's 828 active CSO permits are held by communities in four states: Illinois, Indiana, Ohio, and Pennsylvania.

Total Permits: 828

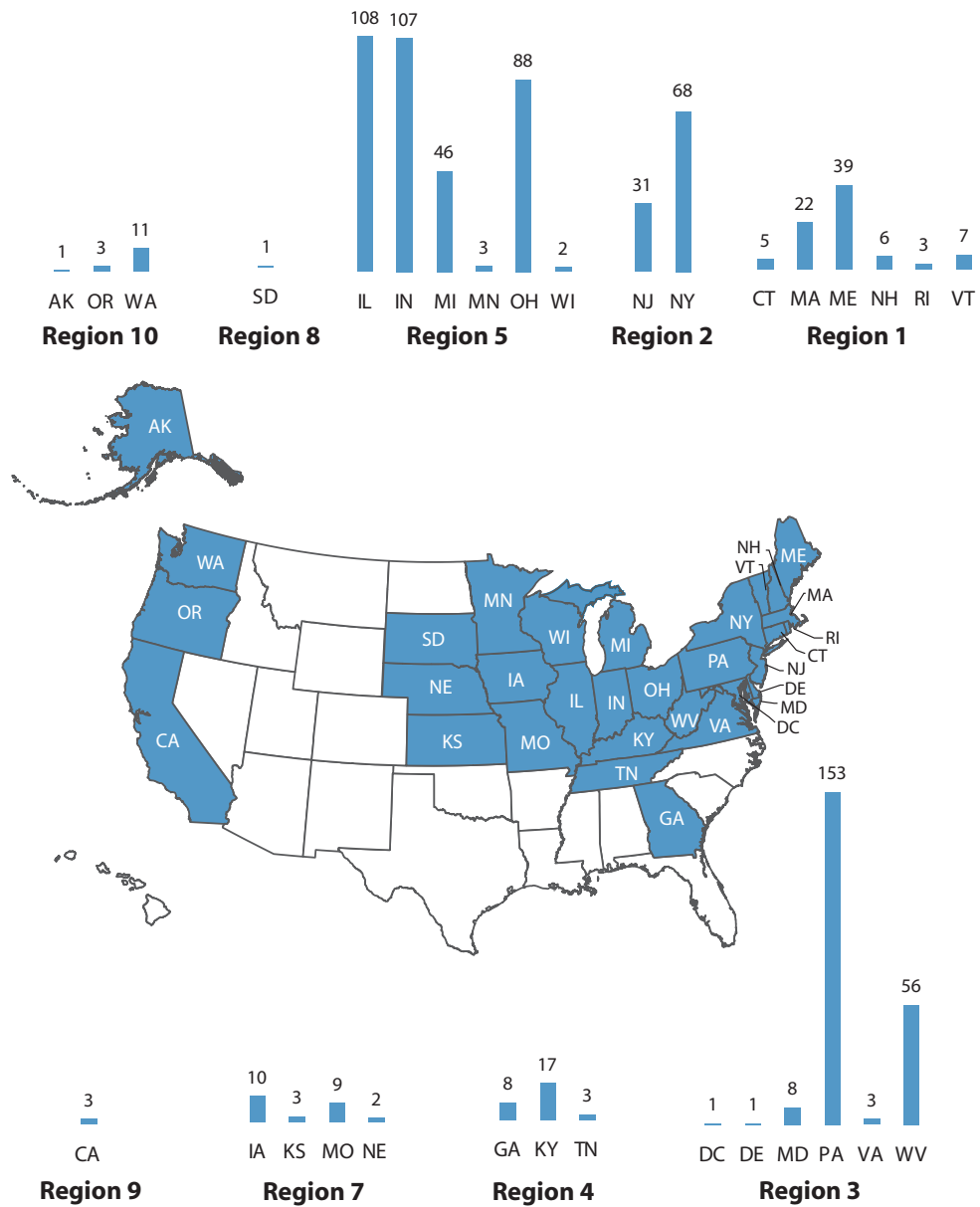
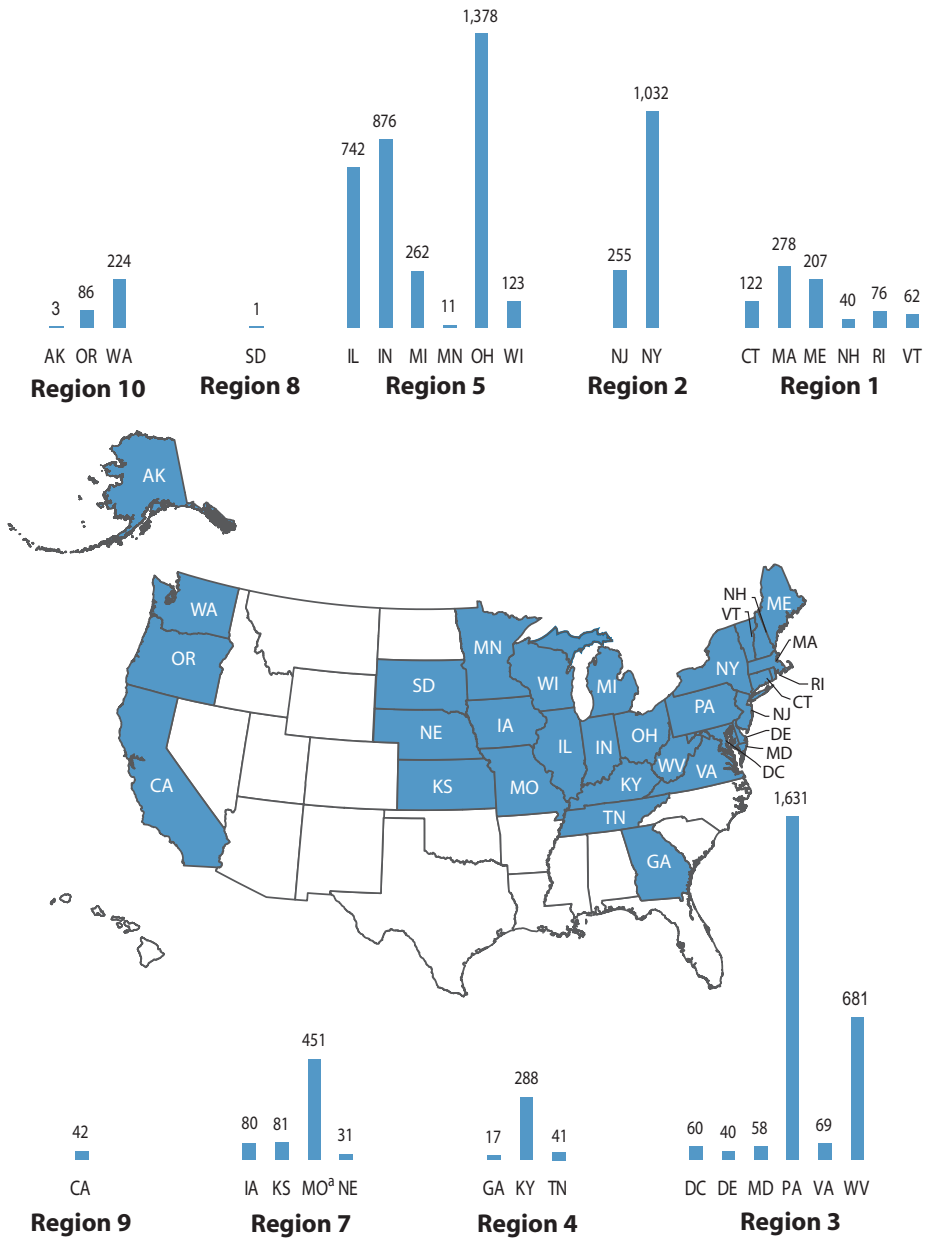

Figure 4.2

Distribution of CSO Outfalls by Region and by State

Similar to the distribution of CSO permits, CSO outfalls are also concentrated in the Northeast and Great Lakes regions.

Total Outfalls: 9,348



^aSince the 2001 *Report to Congress—Implementation and Enforcement of the Combined Sewer Overflow Control Policy*, the Missouri Department of Natural Resources has been working with its CSO communities to confirm the number of CSO outfalls for each NPDES permit. The significant increase in the number of CSO outfalls in Missouri is a result of this effort.

NPDES permittees are classified by regulatory authorities as “major” or “minor” dischargers. Facilities are classified as “major” when the wastewater treatment plant is designed to discharge more than 1 mgd. Facilities with flows less than 1 mgd may be classified as “major” when the NPDES authority determines that a specific permit needs a stronger regulatory focus. Classification as “major” is used to guide permitting, compliance, and enforcement activities to ensure that larger sources of pollutants are given priority. Major facilities are typically inspected annually and must report monthly effluent concentrations and loadings. Based on information available in EPA’s PCS for the 828 active CSO permits, EPA found that 57 percent were classified as major facilities. Facilities classified as “minor” usually have design flows less than 1 mgd.

The CSO Control Policy established a population threshold of 75,000 to define small jurisdictions that may be held to less rigorous requirements

in developing an LTCP for CSO control. EPA does not have population data by permit for CSSs. EPA has previously estimated that average daily wastewater flows are approximately 100 gallons per capita per day (EPA 1985). As a surrogate, plants treating 7.5 mgd (75,000 x 100 gallons per capita per day) are used to define the upper limit of a small jurisdiction.

EPA obtained flow data for 398 of the 616 permits for CSSs that include a POTW. As shown in Figure 4.3, 73 percent of CSO permits (with available flow data) are for POTWs with design flows less than 7.5 mgd, and therefore an estimated service population of less than 75,000.

4.5 What are the Characteristics of CSOs?

An accurate characterization of the frequency, volume, and location of CSO discharges, coupled with information on the pollutants present in the discharges, is

Figure 4.3

Distribution of POTW Facility Sizes Serving CSSs

POTWs serving CSSs are designed to treat flows ranging from 0.1 mgd to 1,600 mgd, but most treat less than 7.5 mgd.

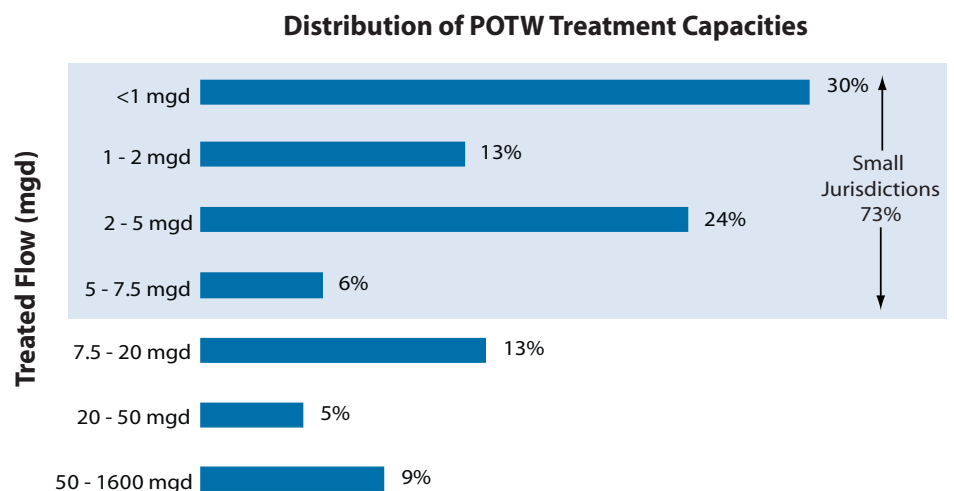

needed to fully evaluate the potential for environmental and human health impacts from CSOs. This section describes the process EPA used to characterize CSO discharges at the national level.

4.5.1 Volume of CSOs

EPA applied the previously developed GPRACSO model to estimate the volume and pollutant loads attributable to CSOs nationwide. A summary of the GPRACSO model and how it was used to derive the national estimates presented in this report is provided in Appendix E.

The GPRACSO model was applied to estimate the CSO volume associated with three planning-level scenarios. Corresponding BOD₅ loads associated with the CSO volumes were also estimated. The three scenarios modeled are:

- Baseline scenario (1992) representing CSO volumes and pollutant loads prior to issuance of the CSO Control Policy.
- Current implementation scenario (2002) representing estimates of CSO volumes and pollutant loads with CSO controls that are currently in place.
- Full CSO Control Policy implementation scenario representing future CSO volume and pollutant loads assuming full implementation of the CSO Control Policy (e.g., four to six untreated overflows per year).

The three scenarios are compared in terms of CSO volume and pollutant load reduction in Table 4.7. National estimates of the annual volume of combined wastewater generated and treated are added for context. The volume of combined wastewater generated represents the volume of domestic, commercial, and industrial wastewater and storm water runoff that enters CSSs across the nation during wet weather periods under annual average conditions. The estimate of combined wastewater treated represents the amount of combined wastewater that receives the minimum treatment specified under

Scenario	Annual Volume (billion gallons/yr)		Annual Load (million pounds/yr)	
	Combined Wastewater Generated	Combined Wastewater Treated	Untreated CSO Discharged	BOD ₅ from Untreated CSO Discharges
Baseline, prior to CSO Control Policy	4,250	3,180	1,070	445
Current level of CSO control	4,230	3,380	850	367
Full CSO Control Policy implementation	4,230 ^a	4,070 ^a	160	159

^a Assumes that the areas and populations served by CSSs will remain relatively constant at current levels through full implementation of the CSO Control Policy.

Table 4.7

Volume Reduction Estimates Based on Implementation of CSO Control Policy

EPA’s GPRACSO model was used to evaluate the potential reduction in discharges of untreated CSO and the attendant BOD₅ loads based on current and future expected implementation of CSO controls.

the CSO Control Policy (primary clarification or equivalent and disinfection, as necessary). The volume of combined wastewater treated under the three scenarios is not constant, as each reflects a different control condition.

EPA took a conservative approach in using the GPRACSO model to estimate reductions in CSO volumes and BOD₅ loads. Only structural CSO controls, such as expanded capacity at a wastewater treatment facility, were considered. Non-structural controls, such as enhanced pretreatment requirements, inflow reduction, and pollution prevention, were not simulated with the GPRACSO model. The fact that sewer separation can lead to increased storm water volumes and loads was not factored into this analysis.

The GPRACSO model estimates that prior to issuance of the CSO Control Policy (baseline scenario) approximately 1,070 billion gallons of untreated CSO and 445 million pounds of BOD₅ were discharged annually from CSSs. Under the current implementation scenario, the GPRACSO model estimates that approximately 850 billion gallons of untreated combined sewage and 367 million pounds of BOD₅ are discharged from CSSs annually. The GPRACSO model estimates that the national CSO volume and associated BOD₅ loads have decreased by 21 percent and 18 percent, respectively, since issuance of the CSO Control Policy.

The full CSO Control Policy implementation scenario assumes that all CSO communities have, at a

minimum, implemented the controls necessary to reduce the frequency of CSO events to an average of four to six untreated CSO events per year. The actual level of control needed to meet water quality standards may require measures beyond those needed for an average of four to six events per year. When full implementation is achieved under this scenario, the GPRACSO model predicts that approximately 160 billion gallons of untreated CSO and 159 million pounds of BOD₅ would be discharged annually from CSSs. Reaching a full implementation of CSO control will require communities with CSSs to provide the equivalent of primary clarification and disinfection, as necessary, to an estimated additional 690 billion gallons of currently untreated CSO discharges.

4.5.2 Frequency of CSOs

In the CSO Control Policy, a “CSO event” is defined as a discharge from one or more CSO outfalls in response to a single wet weather event. The frequency of CSO events in a given community can range from zero events to 80 or more per year. The frequency of CSO events in a given community can also vary considerably from year to year depending on weather conditions. The CSO Control Policy specifies that the evaluation of CSO control alternatives and development of LTCPs should be on a system-wide, annual average basis. Annual average conditions are typically established by performing a statistical analysis on local, long-term precipitation records that consider the number of precipitation events per year, maximum rainfall intensity, and average storm duration.

In addition to estimating national CSO volumes and pollutant loads, the GPRACSO model was used to estimate the frequency of CSO events. Under the baseline scenario, prior to issuance of the CSO Control Policy, the GPRACSO model estimates that there were approximately 60,000 CSO events per year nationwide. Under the current implementation scenario with the current level of CSO control, the GPRACSO model estimates there are 43,000 CSO events per year nationwide, a reduction of 28 percent since the issuance of the CSO Control Policy.

4.5.3 Location of CSOs

A key EPA initiative undertaken as part of this Report to Congress was to update, verify, and digitally georeference the inventory of CSO outfalls documented as part of EPA's 2001 *Report to Congress—Implementation and Enforcement of the CSO Control Policy*. This effort resulted in establishing latitude and longitude coordinates for more than 90 percent of CSO outfalls.

With this new information, EPA was able to associate those CSO outfalls with latitude and longitude coordinates with specific waterbody segments (reaches) identified in the NHD. The NHD is a comprehensive set of digital spatial data of surface water features that enables analysis of water-related data in upstream and downstream order. Associating CSO outfall locations with the NHD-indexed assessed waters allowed analysis of the types of waterbodies receiving CSO discharges. Through

this analysis, EPA found:

- 75 percent of CSOs discharge to rivers, streams, or creeks;
- 10 percent of CSOs discharge to oceans, bays, or estuaries;
- 8 percent of CSOs discharge to waters that are unclassified or unidentified in the NHD;
- 5 percent of CSOs discharge to other types of waters (unnamed tributaries, canals, etc.); and
- 2 percent of CSOs discharge to ponds, lakes, or reservoirs.

Further, associating CSO outfall locations with the NHD-indexed assessed waters allowed comparison with impairments reported by states in the 303(d) program (waters not meeting water quality standards or not supporting their designated uses), and the location of protected resources and sensitive areas. These analyses are discussed in more detail in Section 5.3 of this report. Additional detail on the CSO analysis using the NHD is presented in Appendix F.

4.6 What is the Universe of SSSs?

EPA's 2000 CWNS reported 15,582 municipal SSSs with wastewater treatment facilities across the nation (EPA 2003b). EPA has also identified an additional 4,846 satellite SSSs that collect and transport wastewater to regional treatment facilities (EPA 2003b). The number of SSSs with wastewater treatment facilities and the number of satellite systems are shown for each state in Figures 4.4 and 4.5, respectively.

Figure 4.4

Distribution of SSSs with Wastewater Treatment Facilities by EPA Region and by State

SSSs are located in all 50 states. EPA's 2000 CWNS reported 15,582 municipal SSSs with wastewater treatment facilities across the nation.

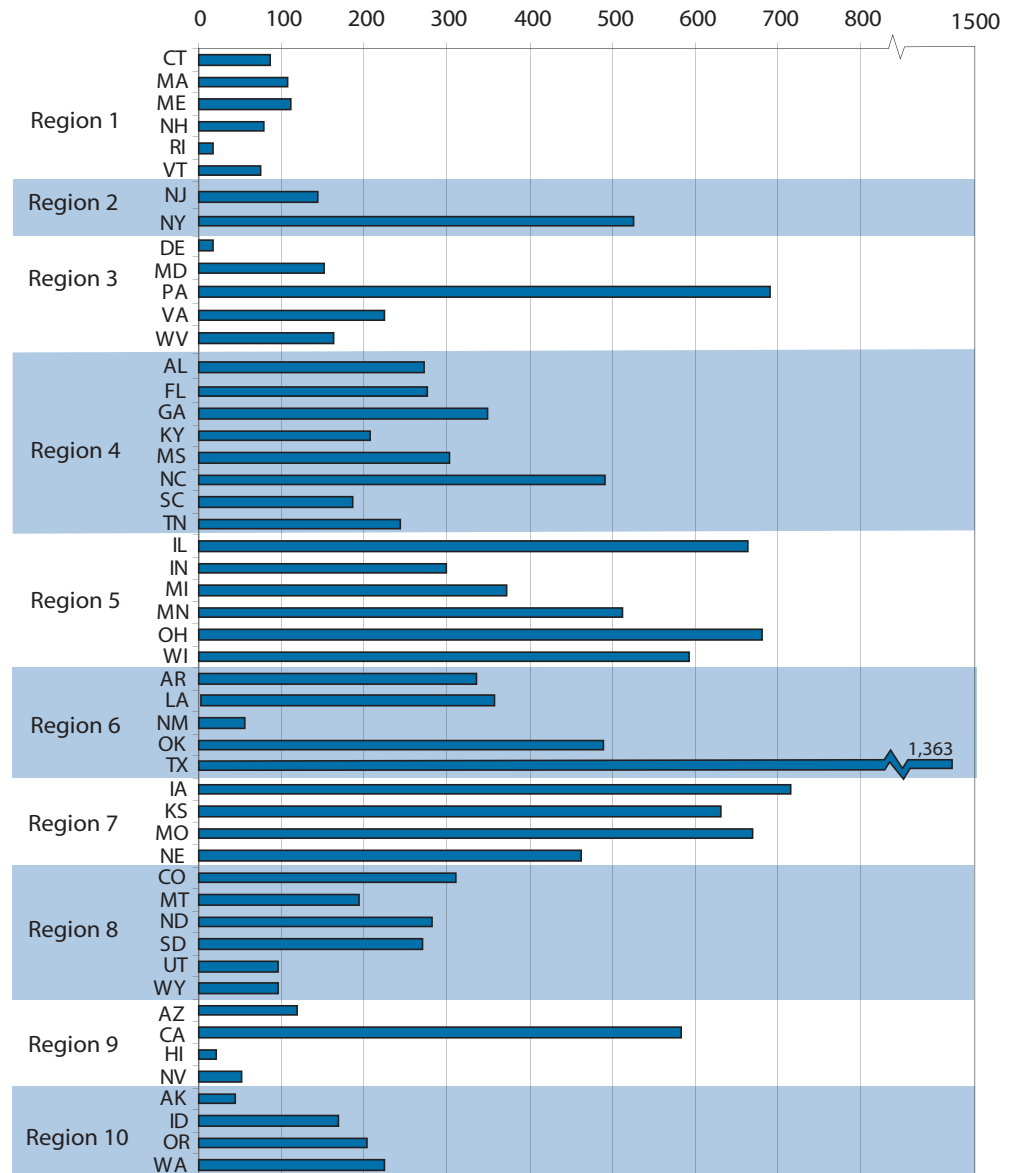
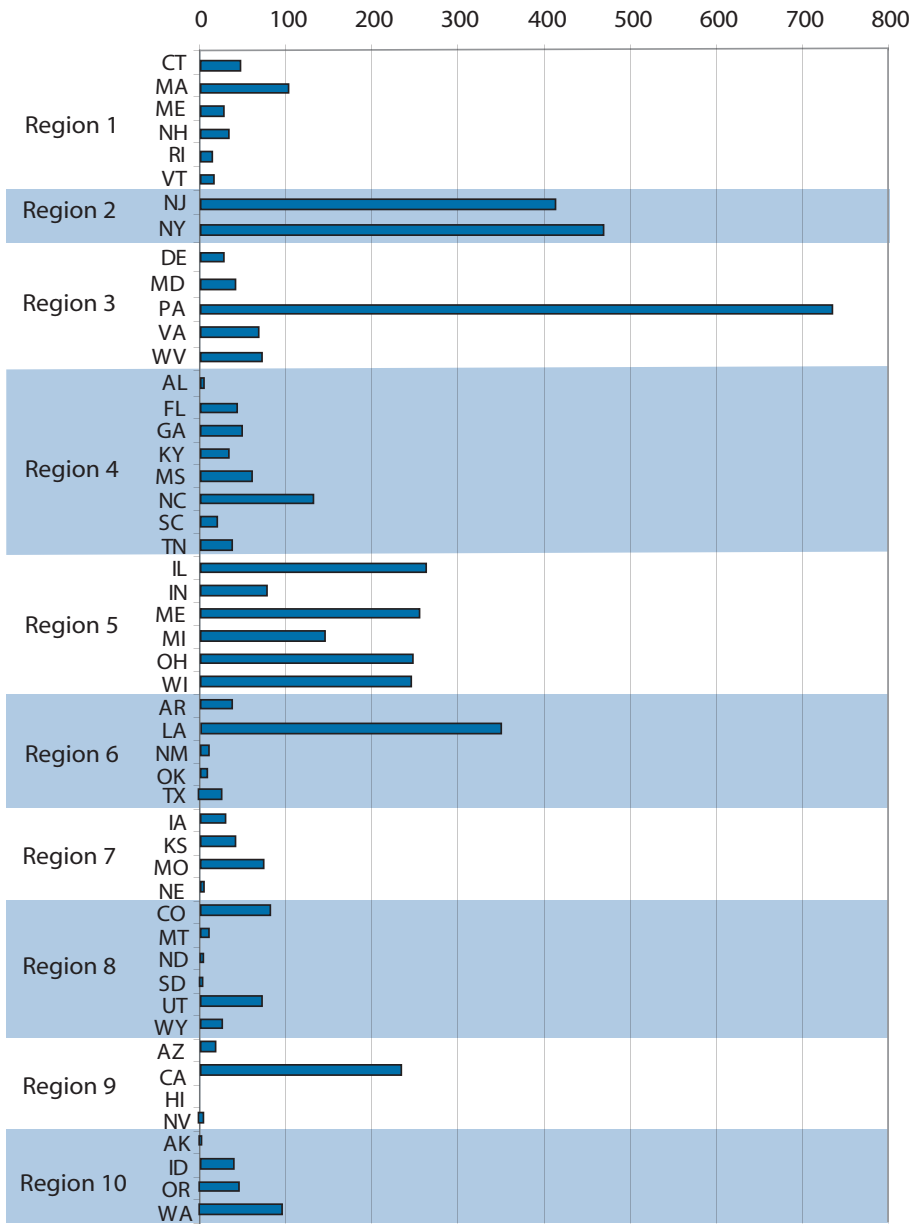

Figure 4.5

Distribution of Satellite SSSs by Region and by State

EPA identified 4,846 satellite SSSs that collect and transport flows to regional wastewater treatment facilities; such systems exist in all states, with the exception of Hawaii.



EPA estimates that 164 million people are served by municipal SSSs. EPA estimates that SSSs contain 584,000 miles of municipally-owned sewer pipes and that approximately 500,000 miles of privately-owned pipes deliver wastewater into SSSs (EPA 2003b).

As described in Section 4.4, NPDES permittees are commonly classified by NPDES authorities as “major” or “minor” dischargers. Based on information available in PCS for permits issued to SSSs with wastewater treatment facilities, EPA found that 80 percent were classified as minor facilities, with average daily discharges less than 1 mgd.

4.7 What are the Characteristics of SSOs?

An accurate characterization of the frequency, volume, and location of SSO discharges, coupled with information on the pollutants present in the discharges, is needed to fully evaluate the potential for environmental and human health impacts from SSOs. Currently, there are no federal systems in place to compile data on the frequency, volume, and location of SSO discharges. This section describes the processes EPA used to characterize SSOs.

Figure 4.6

States Providing Electronic Data on SSO Discharges

EPA identified 25 states in which the NPDES authority is using an electronic data system to track the volume, frequency, location, and cause of SSO discharges within its jurisdiction. Data from these states were used to develop national estimates of SSO frequency and volume.

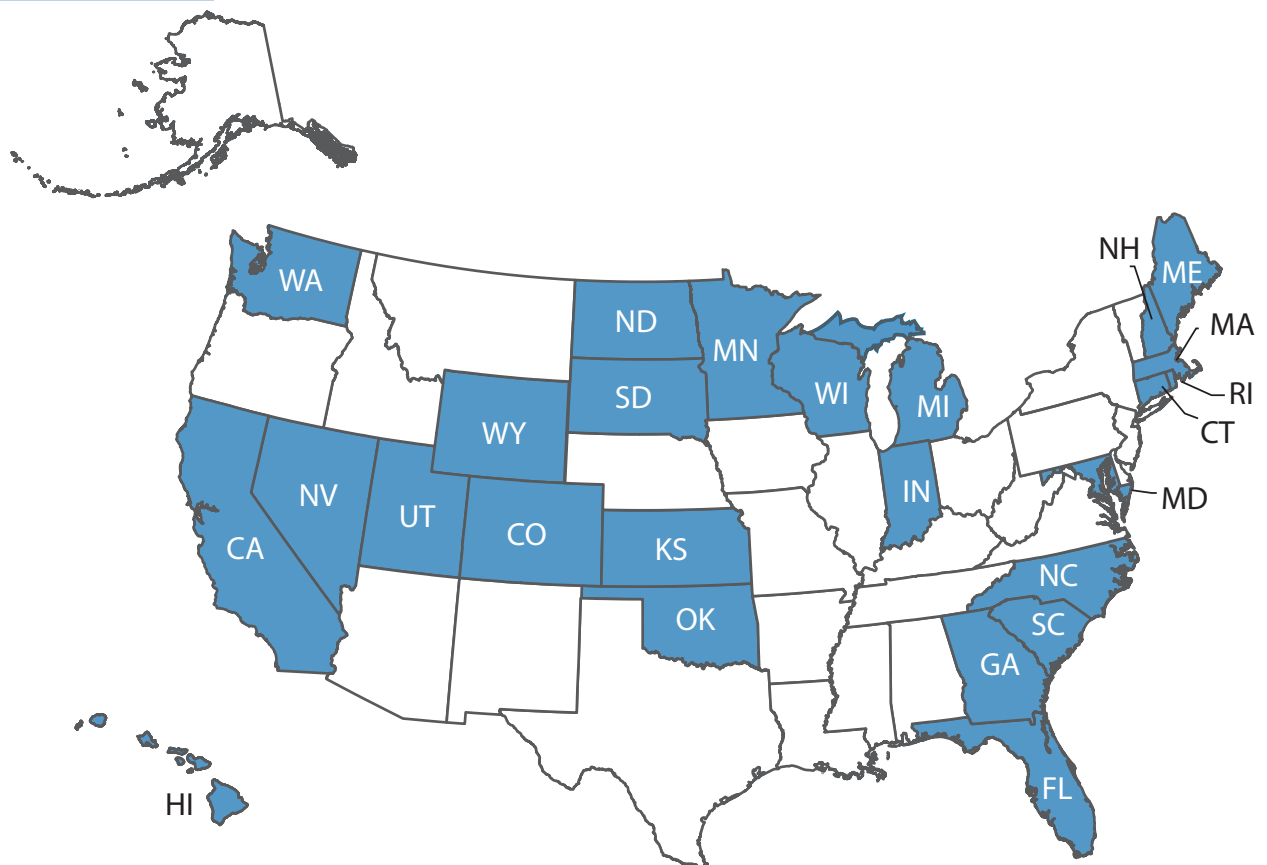

4.7.1 SSO Data Management System

For the purposes of this report, EPA identified 25 states where the NPDES authority is using an electronic data system to track the volume, frequency, location, and cause of SSO discharges within its jurisdiction. As shown in Figure 4.6, these 25 states are spread across the nation.

EPA collected the individual state datasets and compiled them in a single SSO data management system. In its collection of SSO data from the states, EPA found that the definition of an “SSO event” varied. For example, some states include incidents such as secondary treatment bypasses which exceed NPDES permit limits by more than 50 percent at the main outfall, and spills from septic haulers as SSO events in their data systems. EPA also found that backups into buildings caused by problems in the publicly-owned portion of an SSS are not tracked by states.

SSOs are untreated or partially treated releases from an SSS. The discussion of SSOs in this report does not include discharges occurring after the headworks of the treatment plant, regardless of the level of treatment; or backups into buildings caused by problems in the publicly-owned portion of an SSS. Datasets for each state were screened using these qualifiers. SSO events that did not meet the above criteria were omitted from the SSO data management system and from the analyses of SSO frequency, volume, and cause presented later in this chapter. Additional information on the data

management system is provided in Appendix G of this report.

4.7.2 Statistical Technique Used to Estimate Annual National SSO Frequency and Volume

National estimates of SSO frequency and volume were generated using reported data on 33,213 SSO events in 25 states that occurred in calendar years 2001, 2002, and 2003, combined with basic information describing the sewerage universe in each state from the 2000 CWNS. This basic state information included:

- Total number of sewer systems by state (combined and separate sanitary);
- Number of SSSs by state; and
- Population served by SSSs by state.

To account for the uncertainty in the data reported by states, two separate scenarios were evaluated:

- The first scenario assumed that SSO events tracked in the state’s data system include all of the SSO events that occurred statewide during the reporting period.
- The second scenario assumed that SSO events tracked in the state’s data system include SSO events from only those communities that chose to report and are therefore a fraction of SSO events that occurred statewide during the reporting period.

Regression analyses demonstrated that the frequency of SSO events in a state is correlated both to the total number of SSSs as well as to the population served, although neither parameter

is a perfect predictor. To account for the uncertainty as to which provides the better national estimate of SSO frequency, two additional sub-scenarios were analyzed:

- Estimating SSO event frequency for non-reporting states based on total number of SSSs in each state; and
- Estimating SSO event frequency for non-reporting states based on the total population served by SSSs in each state.

National estimates of SSO volume were generated using the following five-step procedure:

1. Tabulate the total number of events and SSO volume for each of the reporting states.
2. Estimate the total number of SSO events per year for each non-reporting state based on a) the number of SSSs in the state, and b) the population served by SSSs in the state.
3. Divide the total number of events in each non-reporting state into

different categories describing the cause of the SSO event, accounting for observed regional differences from the 25 reporting states.

4. Calculate SSO volume for each cause category in each non-reporting state, accounting for observed regional differences.
5. Calculate national estimates by summing the total number of events by state and the total volume across all states.

A detailed explanation of the statistical techniques applied to the SSO data provided by the 25 states is presented in Appendix G.

4.7.3 Frequency of SSOs

Between January 1, 2001, and December 31, 2003, 33,213 SSO events were reported by individual communities in the 25 states. During this three-year period, 2,663 communities reported one or more SSO discharges. The number of SSO discharges reported by each community is presented in Figure 4.7. As shown, most of the 2,663

Figure 4.7
Total Number of SSO Events Reported by Individual Communities, January 1, 2001 - December 31, 2003
 Nearly 70 percent of the communities in the 25 states reported between one and four SSO events during the three-year reporting period.

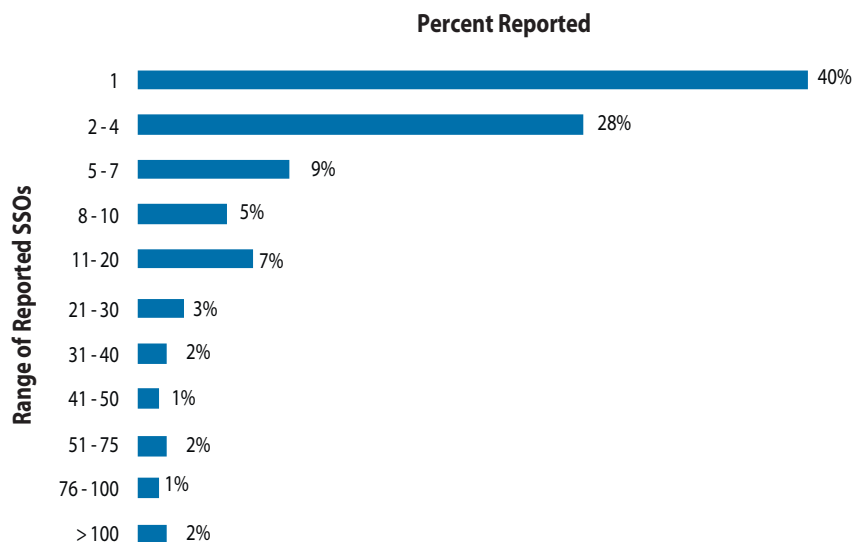

communities reported between one and four SSO events during the three-year reporting period. One community reported more than 1,300 SSOs over the three years.

Using the statistical techniques described previously, and in Appendix G, SSO frequency information in the SSO data management system was extrapolated into a national estimate. This analysis suggests that between 23,000 and 75,000 SSO events per year occur in the United States. EPA evaluated the SSO frequency information in the SSO data management system for regional trends and found only marginal regional effects for overall event frequency. Therefore, EPA did not make adjustments to the estimated number of SSO events in non-reporting states based on geographic location.

4.7.4 Volume of SSOs

Estimated SSO volumes were reported and available for 28,708 (86 percent) of the 33,213 events included in the SSO data management system. Between January 1, 2001, and December 31, 2003, a total of 2.7 billion gallons of SSO was reported discharged in the 25 states. The reported volume for individual SSO events ranged from one gallon to 88 million gallons. The distribution of reported SSO volumes for these events is presented in Figure 4.8. As shown:

- More than half of the reported SSOs were less than 1,000 gallons;
- More than 80 percent of the SSOs were less than 10,000 gallons; and
- Approximately 2 percent of the SSOs were greater than 1 million gallons.

Further, the 1,000 largest SSO events (3 percent of reported events) accounted for almost 90 percent of the total SSO volume reported.

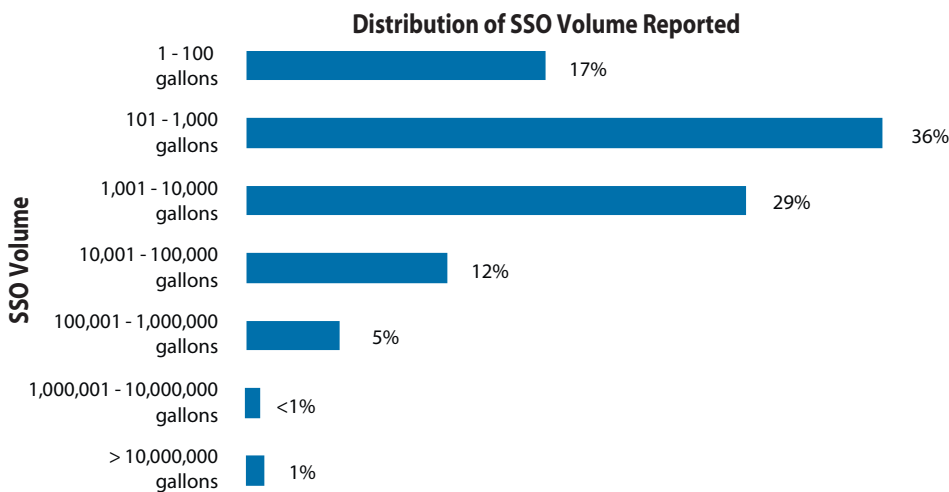

Figure 4.8

Distribution of SSO Volume Reported Per Event

Estimated SSO volumes were available for 86 percent of events in the SSO data management system. The reported volumes for individual SSO events ranged from one gallon to 88 million gallons.

Using the statistical techniques described in Appendix G, data on the volume discharged during individual SSO events were extrapolated into a national estimate of the annual volume of SSO discharged. This analysis suggests that the total SSO volume discharged annually is between three and 10 billion gallons.

In an unpublished EPA report supporting a draft rulemaking on SSOs, EPA previously estimated that the national volume of SSO discharges caused by wet weather totaled 311 billion gallons per year. That estimate was derived from a model designed to predict the relationship between the frequency of wet weather SSO events and the required national investment in SSO control measures. The model was based on variables such as sewer system capacity, acreage served by SSSs, and the percentage of rainfall that became I/I. Values assigned to each of these variables were based on very little empirical data, and the output of the model was not verified. EPA has a much higher degree of confidence in the national SSO volume estimates presented in this Report to Congress because the new estimates are based on a much larger empirical data set and rely on a simplified approach for extrapolating to a national estimate.

4.7.5 Location of SSOs

SSOs can occur at any location in the SSS, including: manholes, cracks and other defects in sewer lines, emergency relief outlets, and elsewhere. Reports of SSO events often include street addresses where the spill occurred. Because SSO events can occur at so many locations, gathering latitude and

longitude for SSOs at a national level is impractical. Rather, it is more useful to look at the cause of the events, which is often linked to the type of location where it occurs. EPA grouped the reported SSO events into five broad cause categories:

- Blockages
- Wet weather and I/I
- Power and mechanical failures
- Line breaks
- Miscellaneous (e.g., vandalism, contractor error)

In general, SSOs attributed to wet weather and I/I are caused by insufficient sewer system capacity, while the other types of spills are attributable to sewer system operation and maintenance.

Cause information was available for 77 percent of the SSO events included in the SSO data management system. As shown in Figure 4.9, 48 percent of all SSO events with a known cause were the result of the complete or partial blockage of a sewer line, and 26 percent of SSO events were caused by wet weather and I/I. In general, the communities reporting large numbers of SSO events have programs that place a strong emphasis on tracking. As a result, EPA believes that these communities are likely to identify additional low-volume SSO events (e.g., SSOs resulting from blockages) that have the potential to go unnoticed or unreported in other jurisdictions.

EPA evaluated the reported causes of SSO events in the SSO data management system for regional trends and found significant

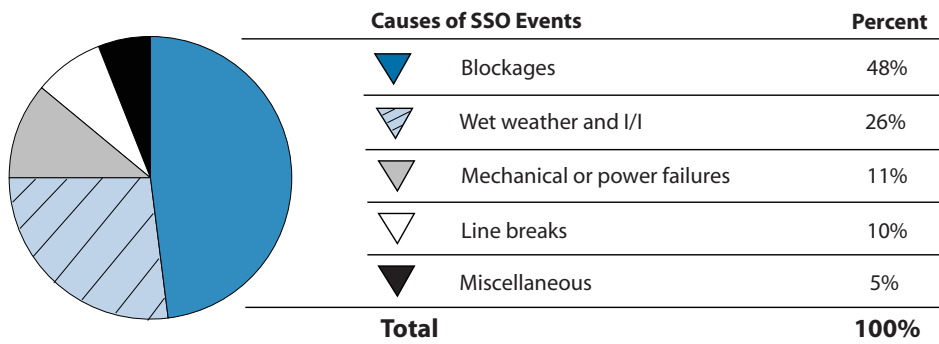

Figure 4.9

Most Common Reported Causes of SSO Events

Nearly 50 percent of all SSO events with a known cause were the result of complete or partial blockage of a sewer line.

differences in the cause of SSO events between EPA regions. Specifically, EPA found that nearly three-quarters of SSO events in the arid Southwest were caused by blockages, while more than half of SSO events in Great Lakes states were attributed to wet weather and I/I. Therefore, average regional distributions for SSO cause were developed and applied in the estimation of SSO volume in non-reporting states. More information on regional trends in SSO cause is presented in Appendix G.

EPA found that individual SSO event volumes show a strong correlation with cause, with the smallest events attributed to blockages and the largest events occurring as a result of wet weather or excessive I/I. As shown in Table 4.8, the average volume of SSO events caused by wet weather or excessive I/I is much greater than the

average volume for any other type of SSO event.

Additional analysis was performed on the cause of SSO events in those communities reporting more than 100 events during a calendar year (either 2001 or 2002); this analysis was done to determine whether the distribution of causes was markedly different in municipalities reporting higher numbers of SSO events. As shown in Figure 4.10, EPA found that communities reporting higher numbers of SSO events attributed a significantly higher percentage of their SSO events to blockages and a correspondingly lower percentage of SSO events to wet weather and I/I.

More detailed information on cause was available for approximately 80 percent of the more than 12,000 SSO events attributed to the complete or

Cause	Average SSO Event Volume (gallons)	Median SSO Event Volume (gallons)	Total Volume (million gallons)	Percent of Total Volume
Blockages	5,900	500	69	3
Wet weather and I/I	360,000	14,400	1,860	74
Mechanical or power failures	63,000	2,000	157	6
Line breaks	172,000	1,500	239	9
Miscellaneous	260,000	1,200	199	8

Table 4.8

SSO Event Volume by Cause

Although wet weather and I/I was listed as the cause for one-quarter of SSO events, these events account for nearly three-quarters of the total SSO volume discharged.

Figure 4.10

Reported Causes of SSOs in Communities Reporting More than 100 SSO Events During a Single Calendar Year

EPA found that communities reporting higher numbers of SSO events (>100 per year) attributed a significantly higher percentage of their SSO events to blockages.

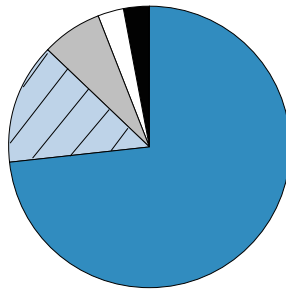

Causes of SSO Events	Percent
Blockages	74%
Wet weather and I/I	14%
Line breaks	7%
Mechanical or power failures	3%
Miscellaneous	2%
Total	100%

partial blockage of a sewer line. As shown in Figure 4.11, grease from restaurants, homes, and industrial sources is the most common cause of reported blockages. Grease is problematic because it solidifies, reduces conveyance capacity, and blocks flow. Grit, rocks, and other debris that find their way into the sewer system account for nearly a third of the reported blockages. Roots are responsible for approximately one quarter of reported blockages. Roots are problematic because they penetrate weaknesses in sewer lines at joints and other stress points, and cause blockages.

4.8 How Do the Volumes and Pollutant Loads from CSOs and SSOs Compare to Those from Other Municipal Point Sources?

As described in Section 4.3, waterbodies receive pollutant loads of the types found in CSOs and SSOs from other urban and rural sources. Responsibility for two of these sources—wastewater treatment plants and urban storm water runoff—belongs almost exclusively to municipalities. Comparing information on annual discharges from municipal sources gives context

Figure 4.11

Reported Cause of Blockage Events

Grease—the most common cause of blockage—solidifies, reduces conveyance capacity, and can eventually block flow in sewers.

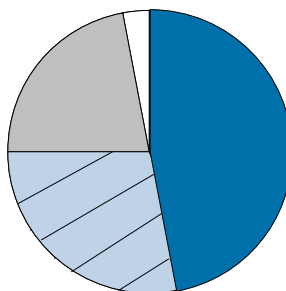

Causes of Blockage Events	Percent
Grease	47%
Grit, rock, and other debris	27%
Roots	22%
Roots and grease	4%
Total	100%

to the magnitude of CSO and SSO discharges. At a national level, as shown in Table 4.9, the volume of CSOs and SSOs discharged is one to two orders of magnitude less than the total flow processed at wastewater treatment plants. The volume of urban storm water runoff generated annually is nearly equivalent to the volume of treated wastewater.

In addition to considering the volumes discharged by various municipal sources, it is also informative to consider their relative contributions in terms of pollutant loads at the national level. The comparisons of BOD₅, TSS, and fecal coliform loads presented in Tables 4.10, 4.11, and 4.12 are based on the volumes presented in

Table 4.9

Estimated Annual Municipal Point Source Discharges

On an annual basis, the volume of CSO and SSO discharged is a proportionally small amount of the total flow processed at municipal wastewater treatment facilities.

Source	Average Discharge Volume (billion gallons)	Percent of Total Municipal Discharges
Treated wastewater ^a	11,425	51%
CSO ^b	850	4%
SSO ^c	10	<1%
Urban storm water runoff ^d	10,068	45%

^a EPA 2000a
^b GPRACSO model, Section 4.5.1
^c High estimate, Section 4.7.4

Table 4.10

Estimated Annual BOD₅ Load from Municipal Point Sources

CSOs and SSOs contribute to a relatively low percentage of the total municipal BOD₅ load discharged annually.

Source	Annual Discharge Volume (billion gallons)	Median BOD ₅ Concentration (mg/L)	Total BOD ₅ Load (lbs. x 10 ⁸)	% of Total Municipal BOD ₅ Load
Treated wastewater	11,425	30	28.5	72%
CSO	850	15-215 ^a	3.7	9%
SSO	10	42	<0.1	<1%
Urban storm water runoff	10,068	8.6	7.2	19%

^a BOD₅ concentrations taken from the GPRACSO model vary with time, as described in Appendix E.

Table 4.11

Estimated Annual TSS Load from Municipal Point Sources

Storm water discharges account for nearly 60 percent of the municipal TSS load discharged annually.

Source	Annual Discharge Volume (billion gallons)	Median TSS Concentration (mg/L)	Total TSS Load (lbs x 10 ⁸)	% of Total Municipal TSS Load
Treated wastewater	11,425	30	28.5	33%
CSO	850	127	8.9	10%
SSO	10	91	< 0.1	< 1%
Urban storm water runoff	10,068	58	48.6	56%

Table 4.12

Estimated Annual Fecal Coliform Load from Municipal Point Sources

CSOs appear to be the most significant source of fecal coliform when compared to other municipal point sources on an annual basis.

Source	Annual Discharge Volume (billion gallons)	Median FC Concentration (#/100 ml)	Total FC Load (MPN x 10 ¹⁴)	% of Total Municipal FC Load
Treated wastewater	11,425	200 ^a	865	1%
CSO	850	215,000	69,172	76%
SSO	10	500,000	1,892	2%
Urban storm water runoff	10,068	5,081	19,362	21%

^a Assumes wastewater treatment includes disinfection

Table 4.9, and on the concentrations presented in Tables 4.1, 4.2, and 4.3. As shown, CSOs and SSOs contribute a relatively low percentage of the total municipal BOD₅ and TSS load discharged annually. CSOs, however appear to be the most significant municipal source of fecal coliform. Further, as shown earlier in Figure 4.1, most CSSs are located in the Northeast and Great Lakes regions. Therefore, the fraction of discharge volume and pollutant load attributed to CSOs in states with many CSSs and locally in communities with CSSs is likely to be much higher. Similarly, communities experiencing frequent and/or high volume SSO events are likely to

attribute a larger percentage of the discharge volume and pollutant load to SSOs.

BOD₅, TSS, and fecal coliform loads from several important watershed sources of pollutants identified in Section 4.3 of this report, including agricultural practices and animal feeding operations, domestic animals and wildlife, and decentralized wastewater treatment systems, are not reflected in these comparisons. It is not practical to estimate the contributions of these various sources to the total annual load of BOD₅, TSS, or fecal coliform on a national level; however, local examples provide some context.

Relative Contribution of CSOs to Bacterial Loads: Rouge River, MI



A recent study on Michigan's Rouge River (a river with a long history of CSOs and pollution problems) assessed the relative contributions of CSOs to overall bacterial indicator loads in the river (Murray and Bona 2001). This study conducted sampling for fecal coliform and fecal streptococci bacteria at 28 sites within the watershed. The results of the study suggest that CSOs contribute 10 to 15 percent of the total bacterial load in the watershed. The authors acknowledge the contributions of a variety of other sources, including non-CSO municipal sources and nonpoint sources. The nonpoint sources mentioned as other contributors included wildlife, domestic animals, rural runoff, contaminated groundwater, and faulty septic systems.

Relative Contribution of CSOs to Bacterial and BOD₅ Loads: Washington, D.C.



The District of Columbia Water and Sewer Authority quantified pollutant loads to receiving waters as part of its modeling analysis to support development of a CSO LTCP (DCWASA 2002). The CSO contribution to the tidal Anacostia River in Washington, D.C., was estimated to be 61 percent for fecal coliform and 14 percent for BOD₅. Similarly, the CSO contribution to Rock Creek was estimated to be 41 percent for fecal coliform and 6 percent for BOD₅. Storm water from Washington, D.C., and suburban areas in Maryland as well as other upstream nonpoint sources accounted for the remaining loads in both watersheds.

Chapter 5

Environmental Impacts of CSOs and SSOs

This chapter describes the extent to which CSOs and SSOs cause or contribute to environmental impacts. The chapter first discusses EPA's framework for evaluating environmental impacts from CSOs and SSOs, using water quality standards. The chapter then summarizes environmental impacts from CSOs and SSOs as reported in national assessments and presents the results of new analyses completed by EPA. Next, site-specific examples are presented to illustrate the types of impacts that CSOs and SSOs have at the local watershed level. Lastly, the factors that affect the extent of environmental impacts caused by CSO and SSO discharges are described.

In conducting data collection and research for this report, EPA found that CSOs and SSOs cause or contribute to environmental impacts that affect water quality and the attainment of designated uses. Pollutant concentrations in CSOs and SSOs alone may be sufficient to cause a violation of water quality standards. Impacts from CSOs and SSOs are often compounded by impacts from

other sources of pollution such as storm water runoff, decentralized wastewater treatment systems, and agricultural practices. This can make it difficult to identify and assign specific cause-and-effect relationships between CSO or SSO events and observed water quality impacts and impairments.

For the purpose of this report, environmental impacts do not include human health impacts. The extent of human health impacts due to CSOs and SSOs is discussed in Chapter 6.

5.1 What is EPA's Framework for Evaluating Environmental Impacts?

EPA's water quality standards program provides a framework for states and authorized tribes to assess and enhance the quality of the nation's waters. Water quality standards define goals by designating uses for the water (e.g., swimming, boating, fishing) and setting pollutant

In this chapter:

- 5.1 What is EPA's Framework for Evaluating Environmental Impacts?
- 5.2 What Overall Water Quality Impacts Have Been Attributed to CSO and SSO Discharges in National Assessments?
- 5.3 What Impacts on Specific Designated Uses Have Been Attributed to CSO and SSO Discharges in National Assessments?
- 5.4 What Overall Water Quality Impacts Have Been Attributed to CSO and SSO Discharges in State and Local Assessments?
- 5.5 What Impacts on Specific Designated Uses Have Been Attributed to CSO and SSO Discharges in State and Local Assessments?
- 5.6 What Factors Affect the Extent of Environmental Impacts Caused by CSOs and SSOs?

limits (criteria) necessary to protect the uses.

Attainment of water quality standards is determined through a process of evaluation and assessment, as follows:

- States adopt water quality goals or standards that, once approved by EPA, serve as the foundation of the water quality-based control program mandated by the Clean Water Act.
- States, EPA, and other federal agencies (e.g., U.S. Geological Survey) conduct water quality monitoring studies to measure water quality and assess changes over time.
- States compare measured water quality to goals or standards in a statewide assessment required under section 305(b) of the Clean Water Act and report conditions as good, threatened, or impaired.
- Waters designated as impaired are included on a state's 303(d) list. A total maximum daily load (TMDL) is required for each pollutant causing impairment. The TMDL establishes an allowable pollutant load that, when achieved, will result in the attainment of the water quality standard.

The discussion of environmental impacts in this chapter is focused on circumstances in which a designated use is not being attained due entirely

or in part to CSO and SSO discharges. The pollutants found in CSOs and SSOs can potentially impact five designated uses:

- Aquatic life support, meaning the water provides suitable habitat for the protection and propagation of desirable fish, shellfish, and other aquatic organisms.
- Drinking water supply, meaning the water can supply safe drinking water with conventional treatment.
- Fish consumption, meaning the water supports fish free from contamination that could pose a significant human health risk.
- Shellfish harvesting, meaning the water supports a population of shellfish free from toxics and pathogens that could pose a significant health risk to consumers.
- Recreation, meaning water-based activities (e.g., swimming, boating) can be performed without risk of adverse human health effects.

As discussed in Section 4.1 of this report, the principal pollutants present in CSOs and SSOs are: microbial pathogens, oxygen depleting substances, TSS, toxics, nutrients, and floatables. Table 5.1 summarizes designated uses likely to be impaired by each of these pollutants.

Table 5.1

Pollutants of Concern in CSOs and SSOs Likely to Cause or Contribute to Impairment	Aquatic life support	Drinking water supply	Fish consumption	Shellfish harvesting	Recreation
Oxygen-demanding substances	●				
Sediment (TSS)	●				
Pathogens		●	●	●	●
Toxics	●		●	●	
Nutrients	●	●			
Floatables					●

Pollutants of Concern in CSOs and SSOs Likely to Cause or Contribute to Impairment

The pathogens present in CSO and SSO discharges have the potential to impact several designated uses, including, drinking water supply, fish consumption, shellfish harvesting, and recreation.

5.2 What Overall Water Quality Impacts Have Been Attributed to CSO and SSO Discharges in National Assessments?

States are required to periodically assess the health of their waters and the extent to which water quality standards are being met. EPA compiles these reports into the NWQI, which offers a comprehensive review of water quality conditions nationwide. This section summarizes findings from the NWQI and describes two original analyses undertaken by EPA to identify potential water quality impacts from CSO and SSO discharges at the national level.

5.2.1 NWQI 2000 Report

Since 1975, EPA has prepared a series of biennial NWQI reports as required under Section 305(b) of the Clean Water Act. The *NWQI 2000 Report*, the most recently published report, is a compilation of assessment reports on the quality of state waters (EPA 2002c). The NWQI Report categorizes assessed waters as follows:

Good – fully supporting all uses or fully supporting all uses but threatened for one or more uses; or

Impaired – partially or not supporting one or more uses.

The national summary of the quality of assessed waters, by type, is presented in Figure 5.1. This summary shows that 19 percent of the nation’s total river and stream miles; 43 percent of lake, reservoir, and pond acres; 36 percent of estuarine and bay square miles; 6 percent of ocean shoreline miles; and 92 percent of Great Lakes shoreline miles were assessed.

EPA’s *NWQI 2000 Report* also identified the types of pollutants or stressors most often found to impair the assessed waters as well as the leading sources of these pollutants. These results are presented in Table 5.2 and Table 5.3, respectively. Overall, EPA found that the three pollutants most often associated with impaired waters were solids, pathogens, and nutrients. All three are present in CSO and SSO discharges. Therefore, at a minimum, CSOs and SSOs contribute

Figure 5.1
NWQI 2000 Report: Summary of Assessed Waters by Waterbody Type (EPA 2002c)
 Waterbody assessments are normally based on five broad types of monitoring data: biological integrity, chemical, physical, habitat, and toxicity. Monitoring data are then integrated for an overall assessment.

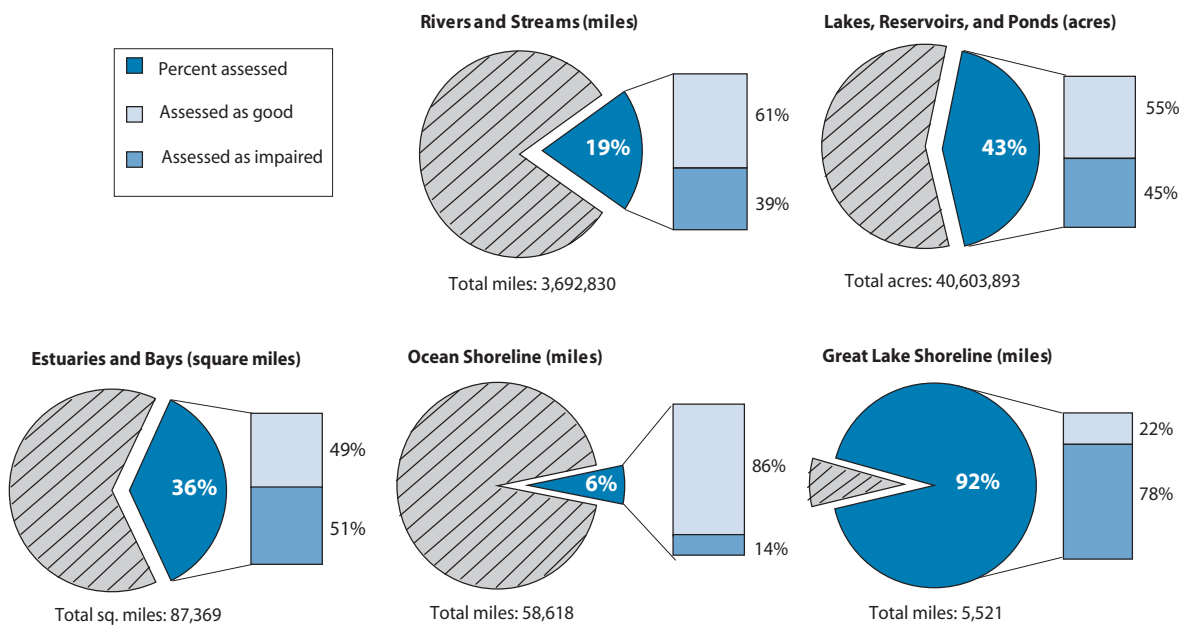

Pollutant/Stressor	Rivers and Streams	Lakes, Ponds, and Reservoirs	Estuaries and Bays	Ocean Shoreline	Great Lakes Shoreline
Habitat alterations	3				
Metals		2	1		
Nutrients	5	1			2
Oil and grease				5	
Oxygen-depleting substances	4	5	3	2	5
Pathogens (bacteria)	1		4	1	3
Pesticides			2		
Priority toxic organic chemicals			5		1
Siltation (sedimentation)	2	3			4
Suspended solids				4	
Total dissolved solids		4			
Turbidity				3	

Table 5.2

Pollutants and Stressors Most Often Associated with Impairment (EPA 2002c)

Overall, EPA found that the three pollutants most often associated with impaired waters were solids (i.e., suspended solids, siltation, and total dissolved solids), pathogens, and nutrients. This table ranks the top five pollutants (or stressors) for each waterbody.

Pollutant Source	Rivers and Streams	Lakes, Ponds, and Reservoirs	Estuaries and Bays	Ocean Shoreline	Great Lakes Shoreline
Agriculture	1	1	5		3
Atmospheric deposition		5	4		4
Contaminated sediment					1
Forestry	5				
Habitat modifications	3				5
Hydrologic modifications	2	2			
Industrial discharges			3		
Land disposal				3	
Municipal point sources			1	5	
Nonpoint sources		4		2	
Septic tanks				4	
Urban runoff/storm sewers	4	3	2	1	2

Table 5.3

Leading Sources of Pollutants and Stressors Causing Water Quality Impairment (EPA 2002b)

Overall, EPA found that pollution from urban and agricultural land, transported by precipitation and runoff, is a leading source of impairment. This table ranks the top five pollutant sources causing water quality impairments.

to the loading of these pollutants where they occur.

The *NWQI 2000 Report* did not cite CSOs or SSOs as a leading source of impairment in any of the five waterbody types listed in Table 5.3 (EPA 2002c). CSOs were identified as a source of impairment for 1,466 square miles (5 percent) of assessed estuaries and 56 miles (1 percent) of Great Lakes shoreline.

The *NWQI 2000 Report* is based on a compilation of individual state assessments, and reporting of the source of impairment varies widely from state to state. The lack of uniformity in assessment and reporting makes it difficult to fully assess the magnitude of CSO and SSO impacts. Inconsistencies in state reporting of CSOs and SSOs as pollutant sources are described below.

Unknown sources and failure to classify: Some states cite unknown pollutant sources or do not attribute impairment to a specific source.

Inconsistent source listing: CSOs are tracked as a specific pollutant source in many, but not all, states where they occur. Twenty of the 32 CSO states identified “combined sewer overflow” as a source of impairment, in the *NWQI* at least once. Where SSOs are identified by states, they are tracked in an inconsistent manner. States use categories such as “collection system failure (SSO),” “wet weather discharges,” and “spills” for tracking SSOs.

Cumulative impacts from multiple pollutant sources: Impacts from CSOs and SSOs are often compounded

by impacts from other sources of pollution, particularly during wet weather. As such, CSOs and SSOs may be grouped into municipal or urban source categories.

EPA is working with the states to develop a framework to promote consistent listing of sources of impairment (EPA 2002d).

5.2.2 Analysis of CSO Outfalls Discharging to Assessed or Impaired Waters

As described in Section 4.5, a key EPA initiative undertaken as part of this report was to update, verify, and digitally georeference the inventory of CSO outfall locations documented as part of EPA’s 2001 *Report to Congress—Implementation and Enforcement of the CSO Control Policy*. Through this effort, EPA established latitude and longitude coordinates for over 90 percent of CSO outfalls. EPA then linked CSO outfall locations to other national-level data and assessments. For example, permitted CSO outfall locations were linked to 305(b)-assessed waters and 303(d)-impaired waters. These analyses are presented in the following subsections. A similar analysis linking permitted CSO outfall locations with classified shellfish growing areas is presented in Section 5.3.2. An analysis of CSO outfall proximity to drinking water intakes is presented in Chapter 6. More information on each of these analyses is provided in Appendix F.

As discussed in Chapter 4, SSOs do not necessarily occur at fixed locations. Therefore, a parallel effort to georeference SSO locations and evaluate their location with respect

to other national-level data and assessments was not possible.

Analysis of CSO Outfalls Discharging to EPA's 305(b) Assessed Waters

EPA was able to compare CSO outfall locations with assessed waters in the *NWQI 2000 Report* through the 305(b) assessment database for 19 CSO states with electronic 305(b) data. The purpose of this analysis was to determine the number of CSO outfalls discharging to waters classified as good or impaired. EPA limited the analysis to assessed water segments located within one mile downstream of a CSO outfall. The results of this analysis are summarized in Table 5.4. EPA found that of the 59,335 assessed water segments in CSO states with electronic 305(b) data only a small number (733 segments) were in close proximity to CSO outfalls. Of these, 75 percent (552 segments) were impaired. The proximity of a permitted CSO outfall to an impaired segment does not in and of itself demonstrate that the CSO is the cause of the impairment. CSOs generally are located in urban areas where waterbodies also receive relatively high volumes of storm water runoff and other pollutant loads. Nevertheless, the high percentage of impairment associated with CSO

outfalls suggests some correlation between impairment and CSOs.

Analysis of CSO Outfalls Discharging to EPA's 303(d) Waters

EPA also compared CSO outfall locations to water segments identified in EPA's Section 303(d) list of impaired waters in states with NHD-index data. For the purpose of this analysis, EPA assumed the causes of reported Section 303(d) impairment most likely attributed to or associated with CSOs were:

- Pathogens
- Organic enrichment, leading to low dissolved oxygen
- Sediment and siltation

Again, EPA limited the analysis to water segments located within one mile downstream of a CSO outfall. The results of this analysis are summarized in Table 5.5. EPA found that although less than one-tenth of one percent (1,560 of more than 1,495,000) of all waterbody segments in CSO states are within one mile of a CSO outfall, between five and 10 percent of the waters assessed as impaired are within that one mile. EPA believes the strong correlation between CSO location and impaired waters is due in part to the

Assessed Waters	Total Assessed	Assessed as Good	Assessed as Impaired	Percent Impaired
Assessed 305(b) segments in CSO states with electronic 305(b) data	59,335	44,457	14,878	25%
Assessed segments within one mile downstream of a CSO outfall	733	181	552	75%

Table 5.4

Occurrence of 305(b) Assessed Waters Within One Mile Downstream of a CSO Outfall

EPA was able to complete this analysis only for states with electronic 305(b) data; that is, for 19 of the 32 states with active CSO permits.

Table 5.5

Occurrence of 303(d) Listed Waters Within One Mile Downstream of a CSO Outfall

Waters within one mile of a CSO outfall are much more likely to be assessed as impaired than a typical water in a CSO state.

Listed Waters	Reason or Cause of Listing		
	Pathogens	Enrichment Leading to Low Dissolved Oxygen	Sediment and Siltation
Total number of listed waters in CSO states	3,446	1,892	3,136
Number of listed waters within one mile of a CSO outfall	191	163	149

following factors: CSOs generally are located in urban areas where waterbodies also receive relatively high volumes of storm water runoff and other pollutant loads; and waters within urban areas are much more likely to be assessed as part of the 305(b) process.

As described in the 305(b) analysis, the existence of a permitted CSO outfall in close proximity to an impaired water does not in and of itself demonstrate that the CSO is the cause of the impairment. It does suggest, however, that CSOs should be considered as a potential source of pollution with respect to TMDL development. EPA has collected anecdotal data demonstrating that CSOs are being considered in TMDL development and that substantial load reductions have been assigned to CSOs in some communities as a result of the TMDL process.

5.2.3 Modeled Assessment of SSO Impacts on Receiving Water Quality

The unpredictable nature of most SSO events makes it difficult to monitor and collect the data needed to measure the occurrence and severity of environmental impacts. As described in Section 4.7 of this report, however, EPA was able to compile a substantial

amount of information on the frequency, volume, and cause of SSO events. From these data, EPA found 72 percent of these SSO events reach a surface water.

Using the national SSO data, EPA developed a simple model for estimating the likely impact of SSO events on different size receiving waterbodies, based on reasonable assumptions about SSO event duration and concentrations of fecal coliform bacteria in SSO discharges. For the purpose of this report, modeled impacts associated with SSO events are evaluated in terms of violations of the single sample maximum water quality criterion for fecal coliform. That is, a predicted concentration of greater than 400 counts of fecal coliform per 100 mL of surface water would be considered to be a water quality standards violation.

The model was run under three different scenarios: one that assumed the entire volume of each modeled SSO discharge reached a surface water (100% delivery), a second that assumed half the volume of each modeled SSO discharge reached a surface water (50% delivery), and a third that assumed ten percent of the volume of each modeled SSO discharge reached a surface water (10% delivery).

Flow in a particular waterbody can increase dramatically with a wet weather event. For example, after an extended period without rain, 2.6 inches of rain fell in the Washington, DC area over two days in late February, 2004. This, in turn, caused flow in local waterbodies to increase by varying amounts—e.g., to 63 times the median flow in the Anacostia River. The flows given reflect the peak daily flow observed due to this rainfall event.

Example: Change in Flow in Washington, D.C. Area Waterbodies as a Result of Wet Weather



Waterbody	Median Flow (cfs)	February Storm Peak (cfs)	Peak Factor
Potomac River	8,490	79,300	9
Monocacy River	624	9,130	15
Goose Creek	250	4,480	18
Seneca Creek	91	1,630	18
Anacostia River	47	2,950	63

Flow varies widely in receiving waters both from year to year and seasonally. Flow can also increase substantially in a particular receiving water during local wet weather events. The potential impact of a specific SSO discharge depends on a number of factors including flow and background pollutant concentrations in the receiving water at the time the discharge occurs, and the volume and strength of the discharge that reaches the receiving water.

SSO-related water quality impacts are presented in Table 5.6 for a range of flow conditions, wastewater strength, and delivery ratios. In general, SSOs consisting of concentrated wastewater are predicted to violate water quality standards the majority of the time, particularly under low flow conditions. In contrast, SSOs consisting of more dilute wastewater are much less likely to cause water quality standards violations, particularly under high flow conditions.

The results of EPA’s simple model of

Table 5.6

Estimated Percentage of Time SSOs Would Cause Water Quality Standard Violations

EPA developed a frequency distribution characterizing typical volumes of SSO events based on available data in order to estimate the likely impact of SSO events on water quality.

Flow Rate (cfs)	Dilute Wastewater (FC = 500,000 #/ml)			Medium Strength Wastewater (FC = 10,000,000 #/100 ml)			Concentrated Wastewater (FC = 1,000,000,000 #/ml)		
	10% Delivery	50% Delivery	100% Delivery	10% Delivery	50% Delivery	100% Delivery	10% Delivery	50% Delivery	100% Delivery
50	12%	27%	36%	45%	68%	77%	95%	99%	100%
100	9%	20%	27%	36%	58%	68%	92%	98%	99%
250	5%	12%	18%	25%	45%	55%	84%	95%	97%
500	3%	9%	12%	18%	36%	45%	77%	92%	95%
1000	2%	6%	9%	13%	27%	36%	68%	86%	92%
5000	1%	2%	3%	5%	13%	18%	45%	68%	77%
10000	0%	1%	2%	3%	9%	13%	36%	58%	68%

A detailed description of the methodology used to develop these estimates is presented in Appendix H. No comparable analysis of SSO discharges to lake or estuarine waters was undertaken.

5.3 What Impacts on Specific Designated Uses Have Been Attributed to CSO and SSO Discharges in National Assessments?

EPA, other federal agencies, and non-governmental organizations periodically conduct national assessments of environmental impacts that are framed in terms of the loss of a specific designated use. Examples include beach closures in waters designated for recreation and shellfish harvesting restrictions in waters designated for shellfishing. This section summarizes findings from a number of national assessments, with emphasis placed on environmental impacts identified as being caused, or contributed to, by CSOs or SSOs.

EPA was unable to identify national assessments that specifically consider the impacts of CSOs and SSOs on aquatic life, although EPA found several state and local watershed assessments which do so. These assessments are discussed in Section 5.5 of this report. Also, for purposes of this report, impairment of drinking water supply as a designated use is considered to be a human health rather than an environmental impact. Consequently, drinking water supply is discussed in Chapter 6 of this report.

5.3.1 Recreation

Recreation is an important designated use for most waters of the United States. The results of national assessments of recreational waters and the causes of impairment are described in the following subsections.

EPA BEACH Program

EPA's Beaches Environmental Assessment and Coastal Health Program (BEACH Program) conducts an annual survey of the nation's swimming beaches, the National Health Protection Survey of Beaches. Nearly 2,500 agencies representing beaches in coastal locations, the Great Lakes, and inland waterways participate in the survey. With respect to designated use impairment during the 2002 swimming season, 25 percent of the beaches inventoried (709 of 2,823) had at least one advisory or closing (EPA 2003a). Elevated bacteria levels accounted for 75 percent of recreational use impairments, manifested as beach advisories and closings. As shown in Figure 5.2, a wide variety of pollutant sources were reported as causing beach advisories and closings. Nearly half of the advisories and closings, however, were reported as having an unknown cause. CSOs were reported to be responsible for 1 percent of reported advisories and closings, and 2 percent of advisories and closings that had a known cause. SSOs (including sewer line blockages and breaks) were reported to be responsible for 6 percent of reported advisories and closings, and 12 percent of advisories and closings that had a known cause.

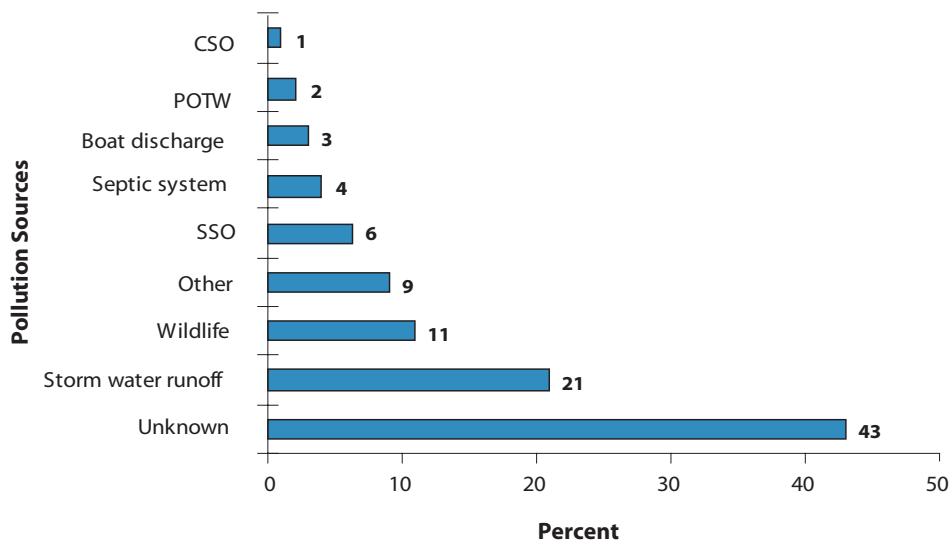

Figure 5.2

Sources of Pollution that Resulted in Beach Advisories and Closings (EPA 2003a)

EPA's BEACH Program conducts an annual survey of the nation's swimming beaches. During the 2002 swimming season, CSOs and SSOs were responsible for 1 and 6 percent, respectively, of reported advisories and closings.

Floatables

Floatables are visible buoyant or semi-buoyant solids that originate from a variety of sources, including CSOs and SSOs. CSOs can be a source of floatables when debris in raw sewage and storm water is released into the receiving waterbody. The type of floatables typically found in CSOs include sewage-related items (e.g., condoms and tampons), street litter, medical items (e.g., syringes), and other material from storm drains, ditches, or runoff (EPA 2002c).

Floatables on beaches and waterways, also known as marine debris, create aesthetic impacts and safety issues that detract from the recreational value of beaches and other public shorelines. As defined by the EPA, marine debris includes all objects found in the marine environment that do not naturally occur there. The marine environment includes the ocean, salt marshes, estuaries, and beaches.

The National Marine Debris Monitoring Program (NMDMP),

coordinated by the Ocean Conservancy (formerly the Center for Marine Conservation) and funded by EPA, maintains a national marine debris database. The NMDMP has conducted monthly beach cleanups since 1996. Volunteers track information on specific marine debris items that are added to the national database. The most frequently collected marine debris items from 1996 to 2002 are presented in Table 5.7 (Ocean Conservancy 2003).

Medical and personal hygiene items are an important component of marine debris. Given the nature and use of these items and their disposal in toilets, CSOs and SSOs are considered a possible source. The Ocean Conservancy's 2003 International Coastal Cleanup, a large one-day event, found a substantial amount of medical and personal hygiene items on U.S. beaches (Ocean Conservancy 2004). More than 7,500 condoms and 10,000 tampons and tampon applicators were collected from 9,200 miles of U.S. shoreline during this event. While this

Table 5.7

NMDMP Marine Debris Survey Results from 1996 - 2002 (Ocean Conservancy 2003)

Funded by EPA is Office of Water, the NMDMP uses standardized data collection methods to determine the status of and trends in marine debris pollution. The data are compiled in a national database.

Marine Debris (excluding ocean-based)	Total Items
Straws	83,714
Plastic beverage bottles	60,426
Other plastic bottles	36,598
Balloons	34,355
Plastic food bottles	18,383
Plastic bottles	11,946
Condoms	1,675
Syringes	1,379
Plastic bags with seam <1 meter	422
Cotton swabs	171
Metal beverage cans	109
Plastic bags with seam > 1 meter	88
Tampon applicators	61
Motor oil containers	19
Six-pack rings	17

information is inconclusive on its own, it does suggest that CSOs and SSOs may contribute to the occurrence of medical and personal hygiene waste found on beaches and other shorelines.

5.3.2 Shellfish Harvesting

Commercial and recreational shellfishing in populated coastal areas has declined steadily since the early 1900s, when outbreaks of typhoid were linked to untreated wastewater. Environmental impacts that restrict shellfish harvesting as a designated use are discussed in the following section. Human health impacts related to the consumption of contaminated fish and shellfish are discussed in Chapter 6.

NOAA National Shellfish Register

NOAA published assessments of classified shellfish growing waters in the contiguous states every five

years between 1966 and 1995. The last report, *1995 National Shellfish Register of Classified Growing Waters*, provided an assessment of 4,230 different classified shellfish growing areas in 21 coastal states (NOAA 1997). Areas open for harvesting are rated as “approved” or “conditionally approved;” areas where harvesting is limited are rated as “restricted” or “conditionally restricted;” and areas where harvesting is not allowed are rated as “prohibited.”

Findings from the 1995 report with respect to shellfish harvesting are as follows:

- 76 percent of all classified waters were approved or conditionally approved for harvest (14.8 million acres);

- 11 percent of all classified waters were restricted or conditionally restricted (3.9 million acres); and
- 13 percent of all classified waters were prohibited (2.8 million acres).

NOAA reported that the primary basis for harvest restrictions was the concentration of fecal coliform bacteria associated with untreated wastewater and wastes from livestock and wildlife. CSOs are one of many sources of fecal coliform that impact

shellfish harvesting. A summary of all pollution sources identified in the 1990 and 1995 National Shellfish Registers as causing or contributing to restrictions and prohibitions is presented in Table 5.8.

A cooperative effort between the Interstate Shellfish Sanitation Conference and NOAA has resulted in the development of a state Shellfish Information Management System. The system will summarize basic information about shellfish programs



CSO controls implemented in Oswego, NY, have helped provide suitable habitat for desirable fish.

Photo: P. MacNeill

Table 5.8

Pollution Sources Reported for Harvest Limitations on Classified Shellfish Growing Waters in the 1990 and 1995 National Shellfish Registers (NOAA 1997)

Compared to the 1990 Register, the 1995 Register shows significant decreases in the acreage that is harvest-limited due to contributions from industry and wastewater treatment plants; the acreage impacted by CSOs remained relatively constant during the five-year period.

Pollution Source	1990 ^a	1995 ^a
Urban Runoff Precipitation-related discharges (e.g., septic leachate, animal wastes) from impervious surfaces, lawns, and other urban land uses	38%	40%
Upstream Sources Contaminants from unspecified sources upstream of shellfish growing waters	46%	39%
Wildlife Precipitation-related runoff of animal wastes from high wildlife concentration areas (e.g., waterfowl)	25%	38%
Decentralized Wastewater Treatment Systems Discharge of partially treated sewage from malfunctioning on-site septic systems	37%	32%
Wastewater Treatment Plants Routine and accidental sewage discharge from public and private wastewater treatment plants with varying levels of treatment	37%	24%
Agricultural Runoff Precipitation- and irrigation-related runoff of animal wastes and pesticides from crop and pasture lands	11%	17%
Marinas Periodic discharge of untreated or partially treated sewage from berthed vessels	–	17%
Boating Periodic discharge of untreated or partially treated sewage from vessels underway or anchored offshore	18%	13%
Industry Routine and accidental discharges from production/manufacturing processes and on-site sewage treatment	17%	9%
CSOs Discharge of untreated sewage/storm water when sewage system capacity is exceeded by heavy rainfall	7%	7%
Total harvest-limited area, in acres	6.4 million	6.7 million

^a Harvest-limited areas are impacted by multiple pollution sources. Annual values do not total 100 percent.

in each state, replacing NOAA's national shellfish register. This system, which will provide spatial data through a web-based interface, is expected to be operational in 2004.

Analysis of CSO Outfalls Discharging Near Classified Shellfish Growing Areas

EPA associated the location of individual CSO outfalls with classified shellfish growing areas as reported by NOAA in 1995, the last year for which national data were available. EPA limited the analysis to classified shellfish growing areas within five miles of a CSO outfall. The number of classified areas was tabulated by shellfish harvest classification. As shown in Table 5.9, harvesting was prohibited or restricted in most of the classified shellfish growing areas that are proximate to CSO outfalls. As discussed earlier under similar 305(b) and 303(d) analyses, the presence of a CSO outfall alone does not necessarily mean that the CSO is causing or contributing to the prohibition or restriction. Many classified shellfish growing areas

where shellfish harvesting is currently prohibited or restricted are in urban areas in the Northeast where CSOs are one of several factors that might account for impairment. Nevertheless, the association between prohibited and restricted conditions and the presence of CSO outfalls is strong.

5.4 What Overall Water Quality Impacts Have Been Attributed to CSO and SSO Discharges in State and Local Assessments?

State and local governments track environmental impacts and gather data for programmatic reasons that are not necessarily included in national assessments. Examples of environmental impacts included in this section were gathered from state and local reports and from watershed studies in which broad assessments of water quality were undertaken. These examples are not meant to be comprehensive. They are presented to illustrate environmental impacts attributed to CSO and SSO

Table 5.9

Harvest Limitations on Classified Shellfish Growing Areas Within Five Miles of a CSO Outfall

Fifty-eight active CSO permits in nine states cover outfalls located within five miles of a classified shellfish growing area. Shellfish harvesting is prohibited or restricted in the majority of the 659 shellfish growing areas in proximity to CSO outfalls national database.

Shellfish Harvest Classification	Number of Classified Shellfish Growing Areas within 5 Miles of a CSO outfall
Prohibited	411
Restricted	80
Approved	154
Unclassified	14
Total	659

discharges, and, in some instances, the site-specific circumstances under which they occurred.

5.4.1 Water Quality Assessment in New Hampshire

In its 2000 *Water Quality Report*, New Hampshire reported that bacteria is the third leading cause of water quality impairment in the state, causing or contributing to 13 percent of the total miles of impaired rivers and streams in the state (NHDES 2000). Elevated levels of bacteria impaired recreational uses as well as shellfish harvesting uses in New Hampshire. The overall sources of water quality impairment to rivers and streams in New Hampshire are presented in Figure 5.3. As shown, unknown sources cause 79 percent of the 642 miles of impairment reported. A total of 24.1 miles were impaired due to CSOs; this represents 3 percent of all impaired waters in the state and 19 percent of impaired waters with a known source of impairment.

5.4.2 Water Quality Assessment of the Mahoning River Near Youngstown, Ohio

Working in cooperation with the City of Youngstown, Ohio, USGS conducted a comprehensive assessment of water quality and habitat in the Mahoning River and its tributaries (USGS 2002). The City of Youngstown has 80 CSOs that discharge to local receiving waters. Water quality monitoring was conducted during 1999 and 2000. CSO discharges were found to contribute to bacterial and nutrient loads observed in the Mahoning River, but they were not the only factor adversely affecting water quality and habitat. USGS found that:

“Improvement of water quality in the lower reaches of the Mahoning River and Mill Creek (a tributary) to the point that each waterbody meets its designated-use criteria will likely require an integrated approach that includes not only abatement of sewer overflow loadings but also identification and remediation of other loadings in Youngstown and improvement of water quality entering Youngtown.”

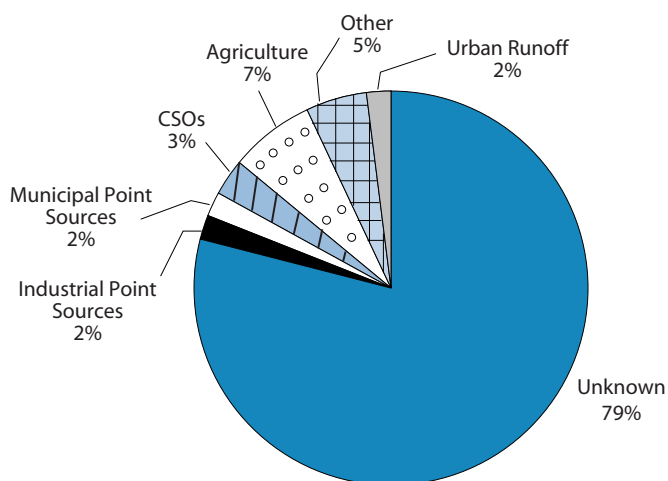

Figure 5.3

Sources of Water Quality Impairment in New Hampshire (NHDES 2000)

In 2000, New Hampshire reported a total of 24.1 miles of rivers and streams impaired by CSOs; this represents 3 percent of all impaired waters in the state and 19 percent of impaired waters with a known source of impairment.

5.4.3 Water Quality in Indianapolis, Indiana

The City of Indianapolis, Indiana, is working to identify and implement CSO controls. The city identified specific water quality problems in waterbodies receiving CSO discharges (City of Indianapolis 2000). The city’s assessment of pollutant sources contributing to water quality problems is presented in Table 5.10. As shown, CSO discharges and wet weather bypasses at POTWs are ranked high relative to other sources of pollution.

5.4.4 Water Quality Risk Assessment of CSO Discharges in King County, Washington

King County, Washington, conducted a CSO water quality risk assessment for the Duwamish River and Elliot Bay, an estuary in Seattle (KCDNR 1999). The water quality assessment consisted of three main parts. First, more than 2,000 environmental samples were collected and analyzed to determine pollutant concentrations in the water, sediment, and tissues of aquatic organisms. Six CSO locations within the estuary were included in

this sampling. The samples were analyzed for 35 chemical, physical, and biological attributes. Next, a computer model was developed to describe water flow and contaminant transport within the estuary. The model was used to estimate current pollution levels in estuarine water and sediment as well as to predict pollution levels after CSO control. Finally, a risk assessment was conducted to determine the impacts of the various pollutants on aquatic life, wildlife, and people that use the estuary. Key study findings with respect to risk reduction resulting from CSO control are as follows:

- No predicted reduction in risks for water-dwelling organisms;
- Some predicted reduction in risks to sediment-dwelling organisms near the CSO discharges;
- A possible increase in the variety of benthic organisms near CSOs as the result of a decrease in organic matter;
- A possible reduction in impacts of localized scouring and sedimentation, which may be

Table 5.10

Relative Contributions of Pollutant Sources to Water Quality Problems in Indianapolis, Indiana (City of Indianapolis 2000)

Indianapolis ranked the contribution of CSO discharges and wet weather bypasses at POTWs high relative to other sources of pollution in local receiving waters. Blank spaces represent negligible or no contribution in comparison to other sources.

Pollutant Source	Dissolved Oxygen Violations	Bacteria Violations	Aesthetic Problems
CSO Discharges	High	High	High
Upstream Sources		Low	
Storm Water		Low	High
Wet Weather Bypass at POTW	High	High	
Electric Utility Thermal Discharge	Low		
Sediment Oxygen Demand	Low		
Dams	Low		
Water Supply Withdrawals	Low		
Septic Tanks		Low	

small compared to the overall scouring impacts of the river and sediment from other sources; and

- No predicted reduction in risks to wildlife as other sources contribute the majority of the risk-related chemicals.

A stakeholder committee composed of local citizens, business owners, environmental organizations, and tribal governments drew the following conclusions from the study results:

- Existing sediment quality and associated risks to people, wildlife, and aquatic life in the estuary are unacceptable;
- Levels of human pathogens and fecal coliform in the estuary are unacceptable;
- Controlling CSOs according to the King County comprehensive sewer plan will improve some aspects of environmental quality; and
- Even if CSOs are completely eliminated, overall environmental quality of the estuary will continue to be unacceptable.

5.5 What Impacts on Specific Designated Uses Have Been Attributed to CSO and SSO Discharges in State and Local Assessments?

Examples of environmental impacts included in this section were gathered from state and local reports and watershed studies; the examples are presented according to the designated use impacted by CSO and SSO discharges. They are

not meant to be comprehensive. They are presented to illustrate representative environmental impacts attributed to CSO and SSO discharges, and, in some instances, the site-specific circumstances under which they occurred. CSO or SSO discharges are clearly the cause of documented environmental impacts in some cases, and are a contributing factor in others. Several examples summarize studies in which impacts from CSOs and SSOs were sought, but were not found.

5.5.1 Aquatic Life Support

The designated use for aquatic life support is achieved when the water provides suitable habitat for the protection and propagation of desirable fish, shellfish, and other aquatic organisms. Oxygen-demanding substances are the principal pollutants found in CSOs and SSOs that can cause or contribute to impaired aquatic life support. CSO and SSO discharges can also contribute sediment, pathogens, nutrients, and toxics to receiving waters, but there is little evidence that levels of these pollutants in CSOs and SSOs are major causes of aquatic life impairment. Select examples of impacts or relevant studies are presented below.

Fish Kills in North Carolina

Reports of impaired aquatic life (i.e., fish kills) have been investigated and documented in North Carolina since 1997 (NCDENR 2003). A summary of fish kills attributed to sewage spills from 1997 to 2002 is presented in Table 5.11. As shown, SSOs are a relatively small cause of the documented fish kills. Other causes of

Table 5.11

Fish Kills Reported in North Carolina: 1997 - 2002 (NCDENR 2003)

Between 1997 and 2002, NCDENR attributed the deaths of nearly 10,000 fish to SSOs (sewer spills).

Year	Total Number of Fish Kills	Number of Fish Kills Attributed to Sewer Spills	Total Number of Fish Killed	Number of Fish Killed in Events Attributed to Sewer Spills
1997	57	8	91,998	8,384
1998	58	3	593,545	336
1999	54	1	1,298,472	200
2000	58	2	716,141	400
2001	77	2	1,369,140	490
2002	45	0	269,635	0

fish kills include chemical spills, heavy rainfall, eutrophication, low dissolved oxygen due to unspecified causes, natural phenomena (e.g., temperature and salinity effects), and unknown causes.

Individual fish kill events linked to sewage spills in North Carolina are presented in Table 5.12. Descriptive comments provided by field crews investigating the fish kills are listed in an abbreviated manner. The oxygen-depleting substances in the spilled sewage appear to reduce oxygen levels to a point at which there is insufficient oxygen to support aquatic life, particularly when spills occur in relatively small streams. No North Carolina communities are served by CSSs.

Assessment of SSO Impacts on Fish and Aquatic Life at Camp Pendleton, California

In September 2000, an SSO occurred at the Marine Corps Base Camp Pendleton near Oceanside, California. The California State Water Resources Control Board investigated the spill, monitored water quality, and assessed the impact of the spill on fish and

aquatic life (Vasquez 2003). The SSO occurred at a deteriorated access port in a sewer force main operated by the Marine Corps. An estimated 2.73 million gallons of sewage was spilled over an eight-day period. Data showed that dissolved oxygen levels in the impacted area dropped below 1 mg/L, well below the numeric criteria of 5 mg/L and levels needed to support most aquatic life, and remained low for several days. The assessment of impacted wildlife documented 320 dead fish, 67 dead shrimp, 169 dead clams, 1 dead snail, and 1 dead bird.

Assessment of PCBs in the Buffalo River, New York

Polychlorinated biphenyls (PCBs) are a contaminant of concern for the Buffalo River in New York and the Great Lakes in general. PCB levels in the river often exceed state water quality criteria, and PCBs found in fish tissue exceed levels allowed by the Food and Drug Administration. In 1994, a study was conducted to identify sources of PCBs to the Buffalo River (Loganthan et al. 1997). Monitoring was conducted in the 700-acre Babcock Creek sewershed, one of 27 sewersheds served by combined

Table 5.12**Fish Kills Caused by Sewage Spills in North Carolina: 1997 - 2001 (NCDENR 2003)**

Oxygen-depleting substances in SSOs (sewer spills) can reduce in-stream dissolved oxygen to levels that are insufficient to support aquatic life.

Date Investigated	Waterbody	Number of Fish Killed	Comments
7/1/97	Tributary to Cokey Swamp	300	Spill of at least 23,000 gallons of sewage
7/14/97	Elerbee Creek	120	Sewer spill at storm drain due to sump overflow
7/29/97	Tributary to Elerbee Creek	100	30,000 gallon spill at pump station
8/13/97	Swift and Mahlers Creeks	1,000	500,000–1,000,000 gallon sewer line spill
8/14/97	Tributary to Northeast Creek	200	20,000 gallon sewer line spill
8/19/97	Coon Creek	3,500	1,200,000 gallon spill at pump station
9/23/97	Little Buffalo Creek	25	50,000 gallon sewage spill
10/7/97	Lovills Creek	3,099	Sewage leakage at junction in sewage lines
11/9/97	East Beaverdam Creek	40	500,000 spill at broken manhole
1/5/98	Cooper's Pond	85	Sewage spill
3/16/98	Unnamed Lake	175	114,000 gallons spilled
7/6/98	Reedy Fork Creek	76	3,000 gallons spilled at pump station
6/29/99	Muddy Creek	200	Sewer overflow reported in area
4/13/00	South Fork Catawba River	200	3,000 gallons spilled
6/9/00	Town Branch	200	5,200 gallons spilled due to blockage
5/3/01	Subdivision Pond	400	Sewage overflow
10/23/01	Tributary to Hare Snipe Creek	90	40,000 gallon sewage spill

sewers in the City of Buffalo. The study detected the presence of PCBs in CSO discharges from the Babcock Creek CSO outfall and confirmed that the city's CSS was a source of PCBs to the river. Monitoring at other study locations as well as watershed modeling indicated that the PCB loadings from unknown, non-CSO sources were more than 10 times greater than the loading from all of the CSOs in the lower Buffalo River (Atkinson et al. 1994).

Whole Effluent Toxicity of CSO Discharges in Toledo, Ohio

Whole effluent toxicity testing uses *Ceriodaphnia dubia* (water flea) and *Pimephales promelas* (fathead minnow) to measure if a discharge is toxic. The City of Toledo, Ohio, conducted whole effluent toxicity testing on samples collected at four separate CSO outfalls during wet weather conditions (Jones & Henry Engineers 1997). In comparison with laboratory control groups, acute (short-term) toxicity was observed in samples from two CSO

outfalls, and chronic (long-term) toxicity was observed in samples from the other two CSO outfalls. Some chronic toxicity effects were also observed in river samples taken above and below the CSO discharges. Parallel modeling analysis of CSO discharges by the City of Toledo identified copper, lead, silver, and zinc as pollutants of concern.

As a result of the testing, Toledo recently developed a draft *Industrial Wastewater Release Minimization Plan* with policies and procedures for minimizing the discharge of industrial wastewater during CSO events (City of Toledo 2003). The plan includes a variety of measures to reduce the volume and concentration of industrial wastewater discharged to the CSS during wet weather events. Eight industrial facilities identified as having the potential to contribute toxics to CSO discharges have implemented or scheduled changes to their operations to reduce flow, load, or both. The city plans to contact the remaining industrial facilities participating in its Industrial Pretreatment Program to encourage operational modifications to reduce the volume and concentration of wastewater discharged to the CSS during wet weather events.

[Analysis of Toxics in CSOs in Washington, D.C.](#)

The District of Columbia Water and Sewer Authority monitored its CSO outfalls for nine months during 1999 and 2000 (DCWASA 2002). The purpose of the monitoring was to characterize the chemical composition of CSO discharges in order to assess

the potential for receiving water impacts. Monitoring was carried out for 127 priority pollutants including:

- Total recoverable metals and cyanide
- Dissolved metals
- Pesticides and PCBs
- Volatiles and semivolatiles

The CSO monitoring data reported by the Water and Sewer Authority indicated that all results for priority pollutants were below the laboratory method reporting limits, except for cyanide, chloroform, and several metals. The cyanide and chloroform concentrations were found to be well below the applicable water quality criteria. Further evaluation of detected metals showed that all but dissolved copper and dissolved zinc were at acceptable levels. Additional analysis using the EPA-approved CORMIX and Biotic Ligand models indicated that the effective instream concentrations of dissolved copper and dissolved zinc were also at acceptable levels. Although Washington, D.C. is not a heavily industrialized city, 25 permitted significant industrial users and approximately 3,000 smaller commercial dischargers (e.g., medical facilities, printing and photocopying facilities) discharge to its sewer system.

[Fish Diversity in Chicago-area Waterways](#)

Prior to the implementation of wastewater treatment facility upgrades in the 1970s and CSO controls in the 1980s, aquatic life suffered in urban Chicago-area streams. The

ability of Chicago-area waterways to support a rich and diverse aquatic community was severely limited by inadequate levels of wastewater treatment, discharges of chlorinated effluent at treatment facilities, and CSO discharges. In particular, CSO discharges contributed large amounts of oxygen-demanding organic substances that depressed oxygen levels in the waterways, and the presence of chlorine in treatment plant effluent contributed to conditions that were toxic to aquatic life. Improved wastewater treatment, including facilities to dechlorinate treated wastewater, and CSO control over the past 30 years have improved the richness and diversity of aquatic life. As shown in Figure 5.4, the total number of fish species found and supported in the principal waterways in Chicago has expanded during this period (MWRD 1998).

5.5.2 Recreation

Primary contact and secondary contact recreation uses are protected when a waterbody supports swimming and other water-based activities,

such as boating, without risk of adverse human health effects from contact with the water. The principal pollutants found in CSOs and SSOs that affect recreational uses at beaches are microbial pathogens and, to a lesser extent, floatables. Select local examples of impacts to recreational uses and relevant studies are presented below. Additional information about potential human health impacts from recreational exposure to water contaminated by CSO or SSO discharges is presented in Chapter 6.

Beach Closures in California

SSOs were identified by the California State Water Resources Control Board as one of several sources of beach pollution in its *California Beach Closure Report 2000* (CSWRCB 2001). Beach closures result from exceedences of bacterial standards. A closure provides the public with notice that the water is unsafe for contact recreation (i.e., swimming poses an unacceptable risk of illness).

The majority of beach closures during 2000 were attributed to unspecified creek and river sources. As shown in

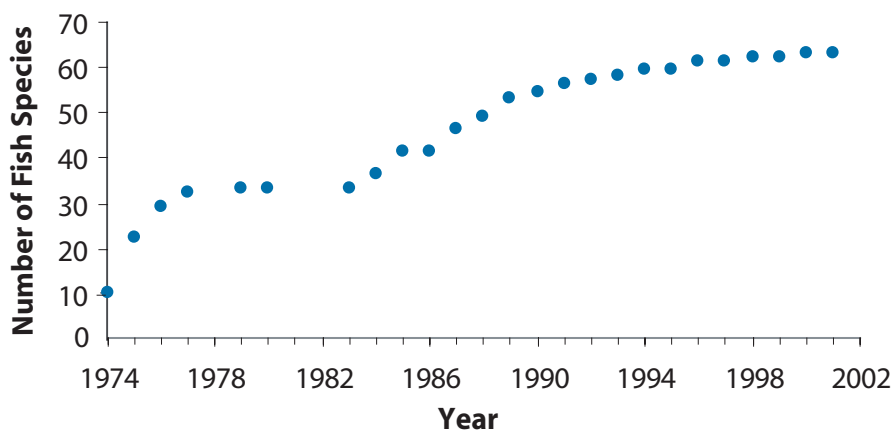

Figure 5.4

Fish Species Found in the Chicago and Calumet River System, 1974 - 2001 (MWRD 1998; Dennisen 2003)

The total number of fish species found in the Chicago and Calumet River system increased six-fold between 1974 and 2001.

Figure 5.5

Sources of Contamination Resulting in California Beach Closures in 2000 (CSWRCB 2001)

In California, problems with sewer lines such as line breaks; blockages due to grease, roots, or debris; and pump station failures have been identified as the cause of a to a significant number of beach closures.

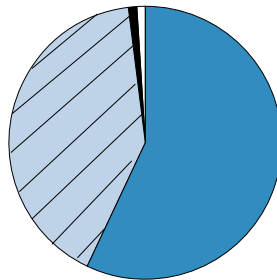

Sources of Contamination Resulting in Beach Closures	Percent
Unspecified river sources	58%
SSOs	42%
CSOs	<1%
Unknown	<1%
Total	100%

Figure 5.5, SSOs accounted for 42 percent and CSOs accounted for less than one percent of all beach closures in California during 2000. California has only two communities with CSSs: San Francisco and Sacramento.

A summary of beach closures due to SSOs in California in 2000 is presented in Figure 5.6. The total number of days that at least one beach was closed is presented in the map by county. The accompanying bar graph shows closures by county in beach-mile days, a measure of beach availability for recreation that integrates miles of beach closed with days of impairment.

Beach Closures in Connecticut

The Connecticut Council on Environmental Quality reported on beach closures in the state in its 2001 Annual Report (CTCEQ 2002). Connecticut’s goal is to eliminate beach closures caused by discharges of untreated or poorly treated wastewater, which Connecticut identified as the most common cause of elevated bacteria levels. Currently, several towns close beaches following a heavy rainfall as a precaution,

presuming that CSO, SSO, and storm water discharges will occur and contaminate water. The average number of days that beaches are closed depends largely on the frequency and amount of rainfall during the beach season. The long-term trend in beach closures reported by the Council is presented in Figure 5.7.

Beach Closures in Orange County, California

Orange County monitors and reports on bacteria levels along 112 miles of its ocean and bay coastline. Major findings documented in its *Annual Ocean and Bay Water Quality Report* (Orange County 2002) are:

- The total number of SSOs reported to the Orange County Health Care Agency has steadily increased over the past 15 years.
- The total number of ocean and bay beach closures due to SSOs has increased each year since 1999.
- The total number of beach mile-days lost as a result of sewage spills has remained constant since 1999.

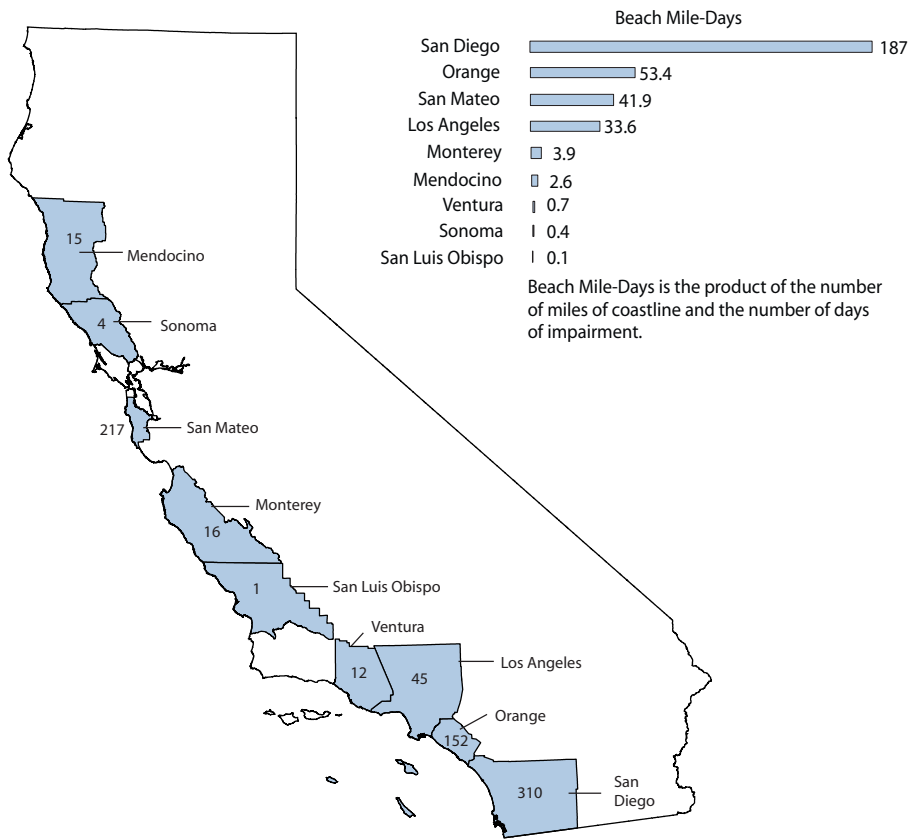

Figure 5.6

Beach Closures in California During 2000 Attributed to SSOs (CASWRCB 2001)

During 2000, nine coastal counties in California reported beach closures as a result of SSOs. Beach closure statistics are presented two ways. The number shown in each county indicates the total number of days that are least one beach in the county was closed in 2000. The number of lost beach mile-days in each county is presented in the adjacent bar chart.

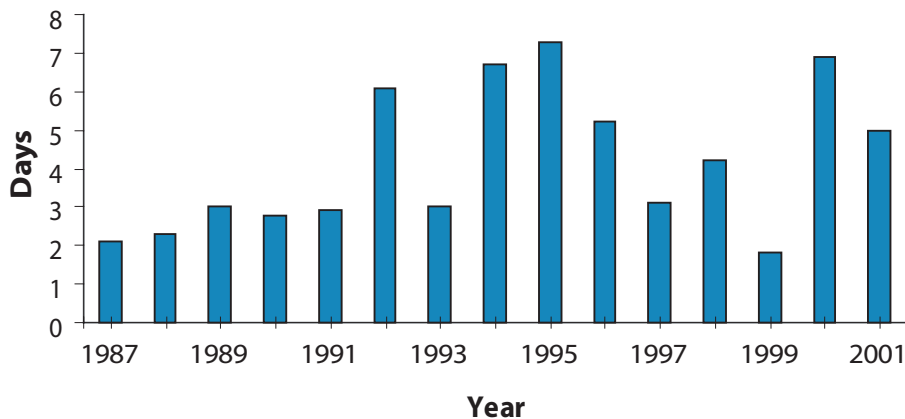

Figure 5.7

Average Number of Days per Year Coastal Municipalities in Connecticut Closed One or More Beaches (CTCEQ 2002)

Yearly variations in beach closures are a product of rainfall patterns and incidents such as sewer line ruptures. In 1999, a relatively dry summer led to less than two closings, on average. The sharp increase in beach closings in 2000 was the result of a rainy summer.

Table 5.13

Summary of Unauthorized Wastewater Discharges in Orange County, California, that Resulted in Beach Closures (Mazur 2003)

Blockages were identified as the cause of approximately three-quarters of all unauthorized wastewater discharges that resulted in beach closures in Orange County between 1999 and 2002.

Cause of Discharge	1999	2000	2001	2002
Line breaks	38	55	69	95
Blockages	210	288	308	409
Pump station failures	14	8	15	11
Treatment plant discharges	0	0	4	2
Miscellaneous	14	25	16	2
Total unauthorized discharges	276	377	412	522

A summary of the specific types of unauthorized wastewater discharges that resulted in beach closures is presented in Table 5.13. As shown, the total number of unauthorized discharges resulting in beach closures increased steadily between 1999 and 2002. However, during this same time period the total number of beach mile-days lost as a result of sewage spills has remained constant, suggesting that the impacts from individual spills have been reduced. The Orange County Health Care Agency attributes the reduced impacts to improvements in wastewater utility response procedures and increased regulatory oversight.

Lake Michigan Beach Closures

The Lake Michigan Federation tracks beach closures in Michigan, Indiana, Illinois, and Wisconsin based on data collected from local health departments, parks managers, and other municipal agencies. EPA and NRDC data were used to augment these sources prior to 2000. The Federation’s tabulation of beach closures from 1998 to 2002 for all of Lake Michigan is presented in Figure 5.8. The Federation believes that CSOs are associated with a high percentage of the beach closures. Other sources of pathogens that cause or contribute

to beach closures include wildlife, storm water runoff, direct human contamination, and re-suspension of bacteria in sediment (Brammeier 2003).

To examine whether CSOs were responsible for beach closures and advisories along Lake Michigan in Cook County, Illinois, the Metropolitan Water Reclamation District of Greater Chicago conducted independent research into river reversals to Lake Michigan (MWRD 2003). River reversals to Lake Michigan occur when, due to heavy rainfall, the gates that separate Lake Michigan and the Chicago River are opened. River water impacted by CSOs is discharged to the lake during river reversals. Swimming at nearby beaches is preemptively banned for two consecutive days by park officials when river reversals occur.

In its report, the District noted that river reversals (and thus the discharge of CSO-impacted waters) to Lake Michigan were infrequent and did not explain most beach closings and advisories (MWRD 2003). Other sources of bacteria at Chicago beaches include sea gulls and bacteria in sand deposits (USGS 2001).

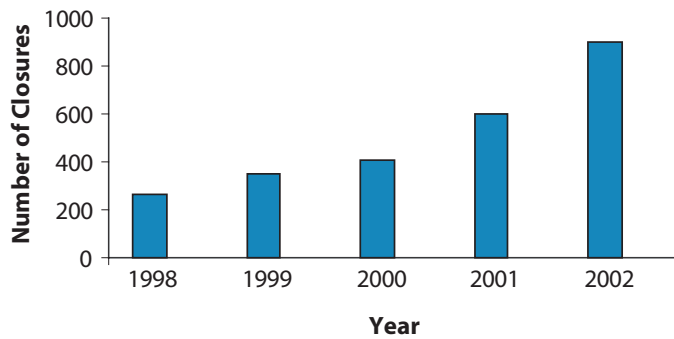

Figure 5.8

Lake Michigan Beach Closures, 1998 - 2002 (Brammeier 2003)

During the 2002 swimming season, authorities issued a total of 919 beach closures and advisories for Lake Michigan. Of the 34 Lake Michigan coastal counties, 65 percent were monitored for beach pollution, up from 50 percent in 2000.

5.5.3 Shellfish Harvesting

The designated use of shellfish harvesting is achieved when a waterbody supports a population of shellfish free from toxics and pathogens that could pose a significant human health risk to consumers. Accordingly, the principal pollutants in CSO and SSO discharges found to impact this use are pathogens, and, to a lesser extent, toxics. An example of shellfishing restrictions imposed as a result of SSO discharges is presented below.

Shellfish Harvest Limitations as a Result of SSO to the Raritan River, New Jersey

On March 2, 2003, a 102-inch diameter sewer in Middlesex County, New Jersey, ruptured and spilled untreated wastewater into residential areas and the Raritan River. Approximately 570 million gallons of wastewater were discharged over a nine-day period while the pipeline was being repaired. Daily monitoring tracked the movement of elevated bacteria levels in the river (NJDEP 2003). The spill caused high levels of fecal coliform in nearby, downstream waters including Raritan Bay, Sandy Hook Bay, and the Navesink River.

EPA and the New Jersey Department of Environmental Protection (NJDEP) sampled affected waters daily and determined that fecal coliform counts were highest in the Raritan Bay (2,400–4,500 fecal coliform counts per 100 mL); counts were also high in Sandy Hook Bay (up to 1,100 fecal coliform counts per 100 mL). Once the spill was stopped, levels of fecal coliform dropped to below 88 counts per 100 mL throughout the river and bay system. By March 15, 2003 (two weeks after the spill began), the highest level reported was in the western end of Raritan Bay at an acceptable level of 43 counts per 100 mL. Fecal coliform was not detected at nearby ocean beaches. The movement of the bacteria plume and its dissipation and dilution over time are illustrated in Figure 5.9.

The spill forced NJDEP to close shellfish beds totaling approximately 30,000 acres in Raritan and Sandy Hook Bays, as well as in the Navesink and Shrewsbury Rivers. Of the total acres closed, more than 6,000 acres were reopened after four weeks, and an additional 20,000 acres were reopened after six weeks (NJDEP 2003).

Figure 5.9

Movement of Bacteria Plume from SSO Discharge in Raritan Bay, New Jersey (NJDEP 2003)

This large SSO event (570 million gallons over nine days, beginning on March 2, 2003) resulted in the closure of more than 30,000 acres of shellfish beds for four to six weeks, until shellfish tissue was clear of fecal coliform, viral, and metal contamination. Data are not shown for the Navesink River and portions of Sandy Hook Bay.

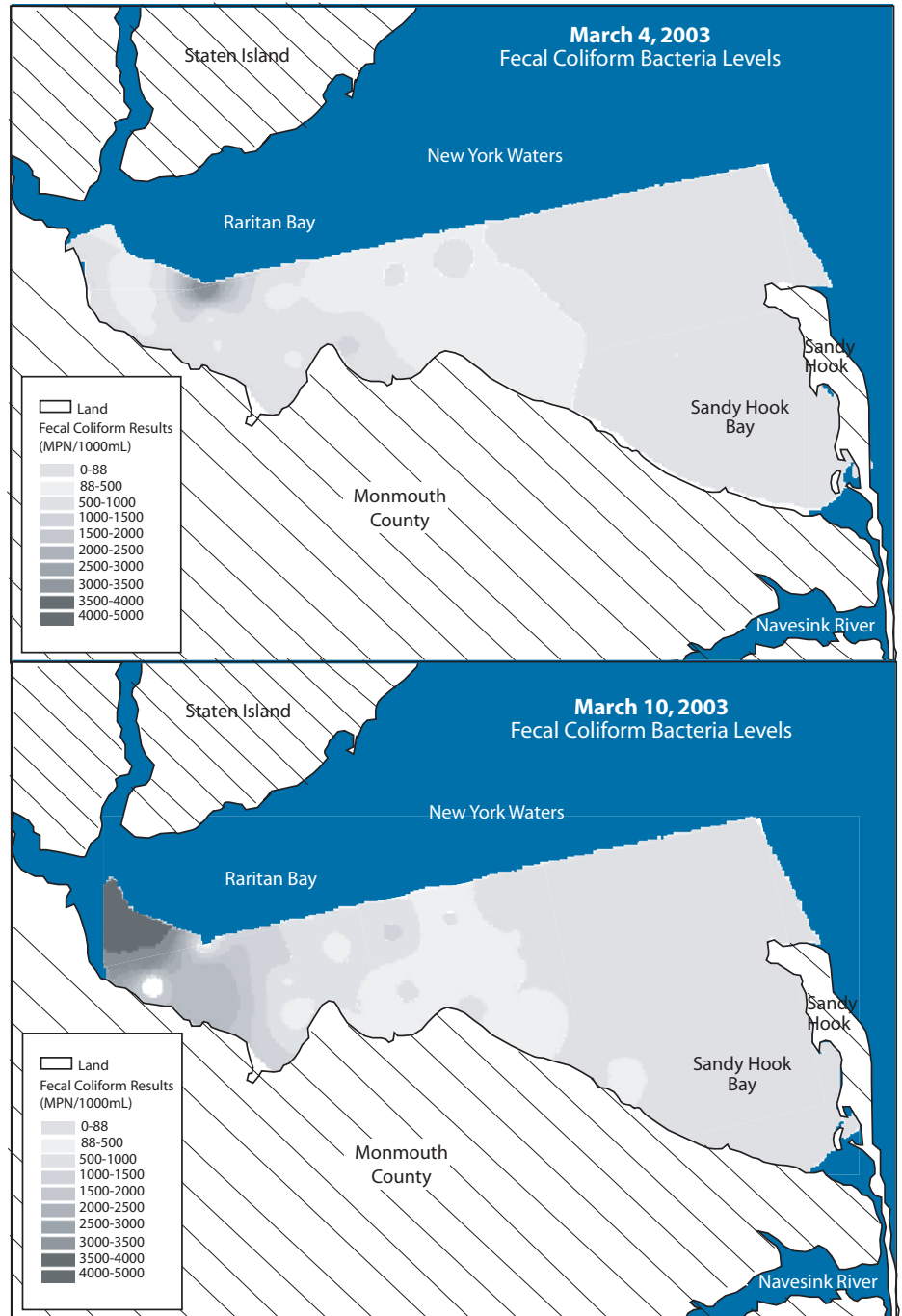

5.6 What Factors Affect the Extent of Environmental Impacts Caused by CSOs and SSOs?

Compiling and presenting information on the extent of environmental impacts caused by CSOs and SSOs is complicated by a number of factors. At the local level, site-specific water quality impacts vary depending on the volume and frequency of CSO or SSO discharges, the size and type of waterbody that receives the overflows, other sources of pollution, and the designated uses for the waterbody. Depending on the particular combination of these factors, impacts from CSOs and SSOs can be visible and intense or relatively minor. Further, because CSO and SSO discharges are intermittent and often occur during wet weather, resulting impacts can be transient and difficult to monitor. This section discusses key factors, including timescale and receiving water characteristics, that affect the extent of environmental impacts caused by CSOs and SSOs.

5.6.1 Timescale Considerations

Although CSO and SSO discharges are intermittent, the resultant impacts may not be temporary and can persist to varying degrees. Some impacts, such as aesthetic impairment due to the presence of floatable material, occur immediately when sewers overflow and are considered short-term impacts. In contrast, nutrients discharged with CSOs and SSOs can contribute to eutrophication on a time scale of weeks or months; such impacts are classified as long-term impacts. Similarly, chronic toxicity impacts associated with metals, pesticides, and synthetic organic

compounds that contaminate both waterbodies and sediments can affect aquatic systems over decades.

5.6.2 Receiving Water Characteristics

The degree to which a CSO or SSO discharge produces an environmental impact in a particular waterbody depends on the rate and volume of the discharge, the degree of mixing and dilution, and the assimilative capacity of the waterbody (see Section 5.2.3). In general, the larger the waterbody and the smaller the discharge, the less likely it is that environmental impacts will occur. In contrast, small waters with little dilution and little assimilative capacity can be severely impacted by relatively small discharges.

Once pollutants are discharged into a waterbody, fate and transport processes determine the extent and severity of environmental impacts. Small-scale hydraulics, such as water movement near a discharge point, determine the initial dilution and mixing of the discharge. Large-scale water movement due to river flow and tidal action largely determine the transport of pollutants over time and distance. Processes identified as most important in assessing the impacts of CSOs and SSOs include:

- Dilution and transport of pathogens and toxics in the water column;
- Deposition of settleable solids;
- Resuspension or scour of settleable solids; and
- Chemical exchange or dilution between the water column and sediment pore water (Meyland et al. 1998).

Chapter 6

Human Health Impacts of CSOs and SSOs

In addition to causing and contributing to the environmental impacts reported in Chapter 5, CSOs and SSOs can cause or contribute to human health impacts. Microbial pathogens and toxics can be present in CSOs and SSOs at levels that pose a risk to human health. Human health impacts occur when people become ill due to contact with or ingestion of water or shellfish that have been contaminated with microbial pathogens or toxics.

Although it is clear that CSOs and SSOs contain disease-causing pathogens and other pollutants, EPA found limited quantitative evidence of actual human health impacts attributed to specific CSO and SSO events. Factors such as under-reporting and incomplete tracking of waterborne illness, the presence of pollutants from other sources, and the use of non-pathogenic indicator bacteria in water quality monitoring often make it difficult to establish a cause-and-effect relationship between human illnesses and CSO and SSO discharges.

This chapter documents and expands the current understanding of human health impacts from CSOs and SSOs. The chapter first describes the pollutants commonly present in CSOs and SSOs that can cause human health impacts. The next sections discuss human exposure pathways; demographic groups and populations that face the greatest exposure and risk of illness; and ways in which human health impacts from CSOs and SSOs are communicated, mitigated, or prevented. The identification and tracking of illnesses associated with CSOs and SSOs are also discussed. Several examples of human health impacts are provided in the chapter.

6.1 What Pollutants in CSOs and SSOs Can Cause Human Health Impacts?

The principal pollutants present in CSOs and SSOs that can cause human health impacts are microbial pathogens and toxics. The presence of biologically active chemicals (e.g., antibiotics, hormones,

In this chapter:

- 6.1 What Pollutants in CSOs and SSOs Can Cause Human Health Impacts?
- 6.2 What Exposure Pathways and Reported Human Health Impacts are Associated with CSOs and SSOs?
- 6.3 Which Demographic Groups Face the Greatest Risk of Exposure to CSOs and SSOs?
- 6.4 Which Populations Face the Greatest Risk of Illness from Exposure to the Pollutants Present in CSOs and SSOs?
- 6.5 How are Human Health Impacts from CSOs and SSOs, Communicated, Mitigated, or Prevented?
- 6.6 What Factors Contribute to Information Gaps in Identifying and Tracking Human Health Impacts from CSOs and SSOs?
- 6.7 What New Assessments and Investigative Activities are Underway?

and steroids) is also a concern but is less well understood at this time.

6.1.1 Microbial Pathogens

Microbial pathogens include hundreds of different types of bacteria, viruses, and parasites. Microbial pathogens of human and non-human origin are present in domestic and industrial wastewater. The presence of specific microbial pathogens in wastewater depends on what is endemic or epidemic in the local community and is often transient. Some microbial pathogens also have environmental sources. In general, microbial pathogens are easily transported by water. They can cause disease in aquatic biota and illness or even death in humans. The three major categories of microbial pathogens present in CSOs and SSOs are bacteria, viruses, and parasites. Fungi do not have a major presence in wastewater (WERF 2003b), and thus in CSOs and SSOs.

Bacteria

Bacteria are microscopic, unicellular organisms. Two broad categories of bacteria are associated with wastewater: indicator bacteria and pathogenic bacteria. Indicator bacteria are common in human waste and are relatively easy to detect in water, but they are not necessarily harmful themselves. Their presence is used to indicate the likely presence of disease-causing, fecal-borne microbial pathogens that are more difficult to detect. Enteric (intestinal) bacteria have been used for more than 100 years as indicators of the presence of human feces in water and overall microbial water quality (NAS 1993). Enteric bacteria commonly used as

indicators include total coliform, fecal coliform, *E. coli*, and enterococci. Further discussion of bacterial indicators is provided in Section 6.6.

Pathogenic bacteria are also common in human waste and are capable of causing disease. Human health impacts from pathogenic bacteria most often involve gastrointestinal illnesses. The predominant symptoms of pathogenic bacterial infections include abdominal cramps, diarrhea, fever, and vomiting. Pathogenic bacteria can also cause diseases such as typhoid fever, although this is not common in the United States. In addition to attacking the human digestive tract, the pathogenic bacteria present in CSOs and SSOs can cause illnesses such as pneumonia, bronchitis, and swimmer's ear. Common pathogenic bacteria, typical concentrations present in sewage (where available), and associated disease and effects are summarized in Table 6.1.

Viruses

Viruses are submicroscopic infectious agents that require a host in which to reproduce. Once inside the host, the virus reproduces and manifests in illness (EPA 1999c). More than 120 enteric viruses are found in sewage (NAS 1993). The predominant symptoms resulting from enteric virus infection include vomiting, diarrhea, skin rash, fever, and respiratory infection. Most waterborne and seafood-borne diseases throughout the world are caused by viruses (NAS 2000). Many enteric viruses, however, cause infections that are difficult to detect (Bitton 1999). A list of common enteric viruses, including typical

Bacteria	Concentration in Sewage ^a (per 100mL)	Disease ^b	Effects ^b	Infective Dose ^{c,d}
<i>Campylobacter</i>	3,700 -100,000	Gastroenteritis	Vomiting, diarrhea	10 ² - 10 ⁶
Pathogenic <i>E. coli</i>	30,000 - 10,000,000	Gastroenteritis	Vomiting, diarrhea, Hemolytic Uremic syndrome (HUS), death in susceptible populations	10 ⁶ - 10 ⁸
<i>Salmonella</i>	0.2 - 11,000	Salmonellosis	Diarrhea, dehydration	10 ⁴ - 10 ⁷
<i>S. typhi</i>		Typhoid fever	High fever, diarrhea, ulceration of the small intestine	10 ³ - 10 ⁷
<i>Shigella</i>	0.1 - 1,000	Shigellosis	Bacillary dysentery	10 ¹ - 10 ²
<i>Vibrio cholera</i>		Cholera	Extremely heavy diarrhea, dehydration	10 ³ - 10 ⁸
<i>Vibrio non-cholera</i>	10 - 10,000	Gastroenteritis	Extremely heavy diarrhea, nausea, vomiting	10 ² - 10 ⁶
<i>Yersinia</i>		Yersinosis	Diarrhea	10 ⁶

^a Details in Appendix I

^c Yates and Gerba 1998

^b EPA 1999C

^d Lue-Hing 2003

concentrations present in sewage (where available), and associated disease and effects are summarized in Table 6.2. Infective doses are not reported; enteric viruses typically are very infectious.

Parasites

Parasites by definition are animals or plants that live in and obtain nutrients from a host organism of another species. The parasites in wastewater that pose a primary public health

Table 6.1

Common Pathogenic Bacteria Present in Sewage

Infective dose is defined as the number of pathogens required to cause subclinical infection. Infective doses are typically given as ranges, as the actual infective dose depends on the pathogen strain and an individual's health condition.

Virus Group	Concentration in Sewage ^a (per 100mL)	Disease ^b	Effects ^b
Adenovirus	10 - 10,000	Respiratory disease, gastroenteritis, pneumonia	Various effects
Astrovirus		Gastroenteritis	Vomiting, diarrhea
Noraviruses (includes Norwalk-like viruses)		Gastroenteritis	Vomiting, diarrhea
Echovirus		Hepatitis, respiratory infection, aseptic meningitis	Various effects, including liver disease
Enterovirus (includes polio, encephalitis, conjunctivitis, and coxsackie viruses)	0.05 - 100,000	Gastroenteritis, heart anomalies, aseptic meningitis, polio	Various effects
Reovirus	0.1 - 125	Gastroenteritis	Vomiting, diarrhea
Rotavirus	0.1 - 85,000	Gastroenteritis	Vomiting, diarrhea

^a Details in Appendix I

^c Yates and Gerba 1998

^b EPA 1999C

^d Lue-Hing 2003

Table 6.2

Common Enteric Viruses Present in Sewage

Enteric viruses are typically very infectious: 1-10 virus particles can cause infection.

concern are protozoa and helminths (NAS 1993). Parasitic protozoa commonly present in sewage include *Giardia lamblia*, *Cryptosporidium parvum*, and *Entamoeba histolytica*. These protozoa cause acute and chronic diarrhea (NAS 1993). *Giardia* causes giardiasis, which is one of the most prevalent waterborne diseases in the United States (EPA 2001e).

Ranges of typical concentrations of protozoa in sewage and information on infective doses are summarized in Table 6.3. As shown, ingestion of a small number of parasitic protozoa is capable of initiating infection. Therefore, the presence of low levels of parasitic protozoa in wastewater is a greater health concern than are low levels of most pathogenic bacteria (NAS 1993).

Helminths, or parasitic worms, include roundworms, hookworms, tapeworms, and whipworms. These organisms are endemic in areas lacking adequate hygiene. Very little documentation of waterborne transmission of helminth infection is available (NAS 1993). Helminth infections can be difficult to diagnose and often exhibit no obvious symptoms.

Indicator Bacteria and Microbial Pathogens in Sewage

Microbial pathogen concentrations in sewage vary greatly depending on the amount of illness and infection in the community served by the sewer system. The time of year can also be important, as some outbreaks of viral disease are seasonal. Average concentrations of indicator bacteria (e.g., fecal coliform) and other microbial pathogens (enteric viruses and protozoan parasites) shed by an infected person are shown in Table 6.4. These high concentrations illustrate that a single person shedding pathogenic organisms can cause a large pathogen load to be discharged to a municipal sewer system.

6.1.2 Toxics

As described in Section 4.1 of this report, toxics are chemicals or chemical mixtures that, under certain circumstances of exposure, pose a risk to human health. Individuals can suffer chronic health effects resulting from prolonged periods of ingestion or consumption of water, fish, and shellfish contaminated with a toxic substance. Generally, metals and synthetic organic chemicals are the

Table 6.3

Common Parasitic Protozoa Present in Sewage

Parasitic protozoa have very low infective doses, which makes their presence in CSO and SSO discharges an important public health concern.

Parasitic Protozoa	Concentration in Sewage ^a (per L)	Disease ^b	Effects ^b	Infective Dose ^c
<i>Cryptosporidium</i>	3 - 13,700	Crypto-sporidiosis	Diarrhea	1 - 150
<i>Entamoeba</i>	4 - 52	Amedbiasis (amoebic dysentery)	Prolonged diarrhea with bleeding, abscess of the liver and small intestine	10 - 20
<i>Giardia</i>	2 - 200,000	Giardiasis	Mild to severe diarrhea, nausea, indigestion	10 - 100

^a Details in Appendix I

^c Yates and Gerba 1998

^b EPA 1999C

Organism	Number per Gram of Feces
Fecal Coliform Bacteria	10^8 to 10^9
Enteric Viruses	10^3 to 10^{12}
Protozoan Parasites	10^6 to 10^7

Table 6.4

Concentration of Indicator Bacteria and Enteric Pathogens Shed by an Infected Individual (Schaub 1995)

This table shows that a single infected person can shed a large number of pathogenic organisms.

toxic substances present in CSO and SSO discharges that can cause human health impacts. Metals and synthetic organic chemicals are introduced into sewer systems through a variety of pathways (Ford 1994). These include permitted industrial discharges, improper or illegal connections, improper drain disposal of chemical remnants, and urban runoff in areas served by CSSs. While the occurrence and concentration of specific toxics in CSOs and SSOs vary considerably from community to community and from event to event depending on site-specific conditions (see Tables 4.4 and 4.5), EPA found no evidence of human health impacts due to toxics in CSO and SSO discharges.

Metals

The metals most commonly identified in wastewater include cadmium, chromium, copper, lead, mercury, nickel, silver, and zinc (AMSA 2003a). In CSSs, storm water can also contribute metals. EPA's Nationwide Urban Runoff Program (NURP) identified copper, lead, and zinc in 91 percent of urban storm water samples collected (EPA 1983a). That is, all three metals were present in 91 percent of samples. Other metals commonly detected in urban runoff include arsenic, cadmium, chromium, and nickel. The NURP Program focused on end-of-pipe samples and

therefore did not consider receiving water impacts.

Metals are a human health concern for two reasons. First, metals are persistent in the environment. This creates an increased chance of long-term human exposure once metals are introduced to a waterbody. Second, metals such as arsenic, cadmium, lead, and mercury bioaccumulate in the human brain, liver, fat, and kidneys, causing detrimental effects. Other impacts that can be caused by metals include dermatitis, hair loss, gastrointestinal distress, bone disease, and developmental illnesses.

Synthetic Organic Chemicals

The synthetic organic chemicals that have been identified in CSOs and SSOs include chlorinated aromatic hydrocarbons such as polychlorinated biphenyls (PCBs), chlorinated hydrocarbons such as pesticides, and polycyclic aromatic hydrocarbons. Synthetic organic chemicals can be ingested by drinking contaminated water or by eating contaminated fish that have bioaccumulated the chemical. Synthetic organic chemicals can also be absorbed through the skin. Their effects on humans range from skin rash to more serious illnesses including anemia, nervous system and blood problems, liver and kidney problems, reproductive difficulties, and increased risk of cancer.

6.1.3 Biologically Active Chemicals

Recent research efforts have begun to consider the presence of biologically active chemicals—antibiotics, caffeine, hormones, human and veterinary drugs, and steroids—in wastewater (Kümmerer 2001). For the most part, these chemicals have not undergone extensive analysis for environmental fate and transport, human health impacts, or ecological impacts. Concerns about the presence of these biologically active chemicals focus on abnormal physiological processes and reproductive impairments, increased incidence of cancer, development of antibiotic-resistant bacteria, and potential increased toxicity of chemical mixtures. Human health effects, however, are largely unknown (Kolpin et al. 2002).

Little is known about the effectiveness of conventional wastewater treatment processes in the removal of these biologically active chemicals. The relative concentrations of these chemicals in CSOs and SSOs are also unknown.

6.2 What Exposure Pathways and Reported Human Health Impacts are Associated with CSOs and SSOs?

Humans may be exposed to the pollutants found in CSOs and SSOs through several pathways. The most common pathways include recreating in waters receiving CSO or SSO discharges, drinking water contaminated by CSO

Sources of Synthetic Organic Chemicals Deposition: NY/NJ Harbor

The New York-New Jersey Harbor Estuary Program sponsored studies to estimate pollutant loads, including loads of synthetic organic chemicals to New York Harbor. As shown, the studies identified six sources of PCB inputs to the harbor. Application of a mass balance water quality food chain model for PCBs indicated that discharges of PCBs to the lower estuary from municipal point sources and CSOs are significant in causing PCB levels in striped bass to exceed the FDA standard for fish consumption (NYNJHEP 1996).

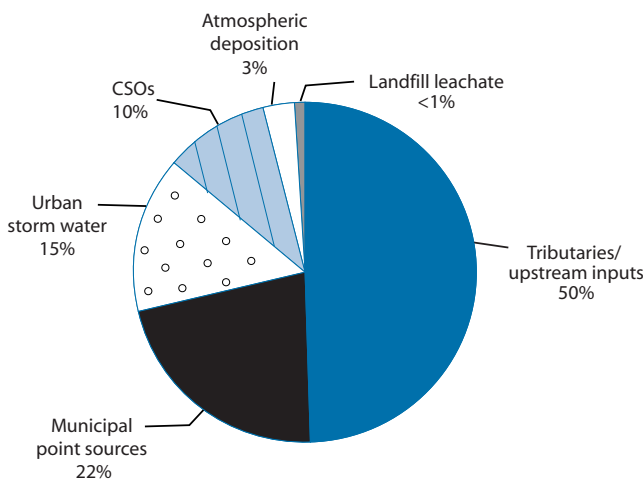

or SSO discharges, and consuming or handling fish or shellfish that have been contaminated by CSO or SSO discharges. Other pathways include direct contact with discharges, occupational exposure, and secondary transmission.

During wet weather events, CSO- and SSO-impacted waterbodies typically receive microbial pathogens and toxics from a variety of other sources including municipal and industrial wastewater discharges, urban storm water runoff, and agricultural nonpoint source discharges. These “interferences” can complicate the identification of specific cause-and-effect relationships between individual CSO or SSO discharges and human health impacts.

6.2.1 Recreational Water

In the United States, millions of people use natural waters (e.g., oceans, lakes, rivers, and streams) each year for a variety of recreational activities. The National Survey on Recreation and the Environment, conducted by the U.S. Forest Service and NOAA, describes nationwide participation in 50 categories of outdoor recreation activities (Leeworthy 2001). The survey estimates the percentage of the population, 16 years of age or older,

participating in water-based recreation activities. Participation in more than one activity in a single water-based recreation category is possible (e.g., respondents may report both sailing and canoeing). Data from the most recent version of the survey (the period of July 1999 to January 2001) are presented in Table 6.5.

A number of studies have documented the risks of gastroenteritis among people recreating in water contaminated with microbial pathogens (NAS 1993; Wade et al. 2003). Recreational exposure generally comes from contaminants suspended in the water column entering the body via oral ingestion. Exposure can also occur through the eyes, ears, nose, anus, genitourinary tract, or dermal cuts and abrasions (Henrickson et al. 2001). Contact with and ingestion of ocean water near wastewater or storm drain outfalls have resulted in increases in reported respiratory, ear, and eye symptoms by ocean swimmers and surfers (Corbett et al. 1993; Haile et al. 1999).

As described in Chapter 5, 25 percent of the beaches inventoried in EPA’s National Health Protection Survey of Beaches under the BEACH Program had at least one advisory or area closing during the 2002 swimming

Table 6.5

Participation in Water-Based Recreation in U.S. between July 1999 and January 2001

The National Survey on Recreation and the Environment estimates nationwide participation in various outdoor recreation activities, including water-based recreation. Participation in more than one activity is possible.

U.S. Population (16 and Older)	Boating/Floating^a	Fishing	Swimming^b
Percent participating	36%	34%	61%
Number in millions	77	72	131

^a Includes sailing, canoeing, kayaking, rowing, motor-boating, water skiing, personal watercraft use, wind surfing, and surfing.

^b Includes swimming in freshwater or saltwater, snorkeling, scuba, and visiting a beach.

season. Elevated bacteria levels were cited as the primary cause for 75 percent of these beach advisories or closures. CSOs were reported to be responsible for 1 percent of reported closings and advisories, and 2 percent of advisories and closures that had a known cause. SSOs (including sewer line breaks) were reported to be responsible for 6 percent of all reported advisories and closings, and 12 percent of advisories and closing that had a known cause (EPA 2003a).

Reported Human Health Impacts

A review of CDC Surveillance Summaries identified 74 waterborne disease outbreaks linked to open recreational waters (i.e., rivers, streams, beaches, lakes, and ponds) from 1985 to 2000. A waterborne disease outbreak is defined by CDC as two or more people experiencing similar illness after exposure to a waterborne pathogen. A total of 5,601 cases of illness were attributed to these 74 waterborne disease outbreaks (CDC 1988, 1990, 1992, 1993, 1996a, 1998, 2000, 2002).

The source of the pathogens causing these waterborne disease outbreaks was not identified in CDC’s reports. These waterborne disease outbreaks, however, were caused by the types of microbial pathogens found in CSOs and SSOs. Figure 6.1 shows that *Shigella*, which is present in CSOs and SSOs, caused the largest number of recreational water-associated outbreaks having a known cause.

Additional information from CDC Surveillance Summaries on outbreaks linked to recreational exposure in fresh or marine waters contaminated with microbial pathogens is presented in Appendix I.

CDC Surveillance Summaries also identify outbreaks linked to swimming pools or hot tubs. For swimming pools and hot tubs, 191 recreational waterborne disease outbreaks with 14,836 cases of illness were reported to CDC between 1985 and 2000 (CDC 1988, 1990, 1992, 1993, 1996a, 1998, 2000, 2002). This is 265 times the

Figure 6.1

Microbial Pathogens Linked to Outbreaks in Recreational Waters, 1985 - 2000

Shigella was the most commonly identified cause of waterborne disease outbreaks linked to recreational waters between 1985 and 2000. *Shigella* has a relatively low infective dose of 10-100 and is typically found in wastewater in concentrations of 0.1-1,000 per 100 mL of sewage.

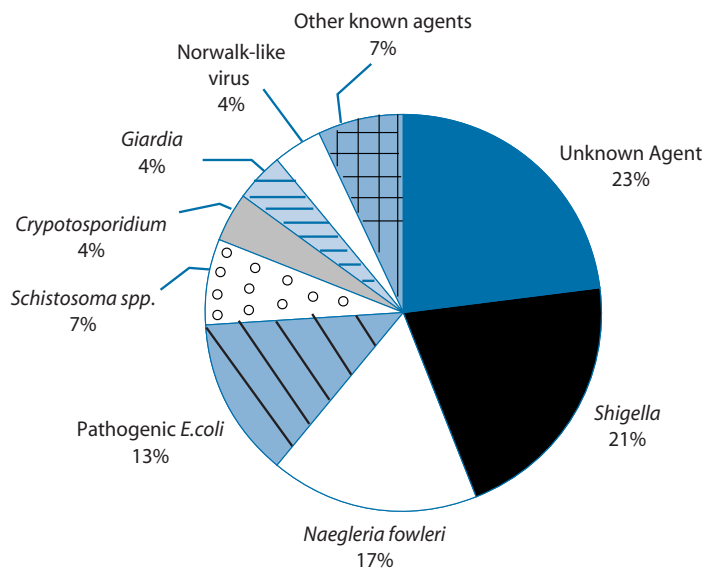

number of illnesses reported for open recreational waters.

Estimated Illnesses at Recognized Beaches

In developing this Report to Congress, EPA found an absence of direct cause-and-effect data relating the occurrence of CSO and SSO discharges to specific human health impacts. Lacking comprehensive data, EPA was able to implement an alternate approach to estimate the annual number of illnesses caused by recreational exposure to CSO and SSO discharges at a small subset of the nation's swimming areas—that is, those recreational beaches recognized by state authorities (“recognized beaches”). EPA's illness estimate was based on existing environmental and recreational use databases. Data limitations made it impossible to develop a comprehensive estimate of illness at all swimming areas at this time, but EPA believes that a significant number of additional illnesses occur in exposed swimmers at many inland and unrecognized beaches.

EPA's estimation of illness at recognized beaches was limited to gastrointestinal illness. EPA employed a multi-step process, including the following:

- Average concentration of fecal coliform bacteria at affected beaches;
- Rate of infection for exposed population; and
- Total annual number of gastrointestinal illnesses.

The number of highly credible gastrointestinal illnesses (HCGI) resulting from human exposure to SSOs and CSOs at recognized beaches was estimated by combining information on the number of exposed swimmer days, the concentration of indicator bacteria to which swimmers are exposed, and the Cabelli/Dufour dose-response functions for marine and fresh waters. First, EPA calculated the total number of illnesses caused by CSOs and SSOs, and then attributed them separately to CSO illnesses or SSO illnesses according to the ratio of CSO to SSO events in the BEACH Survey. A more detailed presentation of EPA's methodology is included in Appendix J.

Results from the analyses are presented in Table 6.6. The range shown reflects differences in how compliance rates with beach advisories were estimated. The lower bound uses a compliance rate of 90 percent, and the upper bound uses a compliance rate of 36 percent. As shown, CSOs and SSOs are estimated to cause between 3,448 and 5,576 illnesses annually at the recognized beaches included in this analysis. This estimate captures only a portion of the likely number of annual illnesses attributable to CSO and SSO contamination of recreational waters.

- Number of recognized beaches using specific management approaches;
- Number of CSO and SSO events impacting recognized beaches;
- Number of individuals exposed annually;

Table 6.6

Estimated Illness Resulting from Recreational Exposure to CSOs and SSOs at Select Beaches

This table shows the portion of the estimated number of annual illnesses attributable to exposure to CSO and SSO contaminated water at state-recognized beaches in the U.S. and its territories.

Source	Lower Bound	Upper Bound
SSOs	2,269	3,669
CSOs	845	1,367
CSO/SSOs	334	540
Total	3,448	5,576

6.2.2 Drinking Water Supplies

Public water systems regulated by EPA, states, and tribes provide drinking water to 90 percent of Americans (EPA 2002e). Approximately 65 percent of the population served by these systems receive water primarily taken from surface water sources such as rivers, lakes, and reservoirs. The remaining 35 percent drink water that originated as groundwater (EPA 1999d).

Reported Human Health Impacts

People can contract waterborne diseases through consumption of municipal drinking water, well water, or contaminated ice. Because drinking water is directly ingested, and it is generally ingested in larger quantities than recreational water that

is accidentally ingested, drinking water is an important pathway of exposure. From 1985 to 2000, 251 outbreaks and 462,169 cases of waterborne illness related to contaminated drinking water were reported to CDC (CDC 1988, 1990, 1992, 1993, 1996a, 1998, 2000, 2002). The vast majority of these cases of illness are from a 1993 cryptosporidiosis outbreak in Milwaukee, Wisconsin, which affected an estimated 403,000 people; the CDC did not specifically identify untreated wastewater as contributing to the Milwaukee outbreak.

As shown in Appendix I, EPA identified a subset of 55 of these 251 outbreaks linked to drinking source water contaminated with human sewage or to drinking water taken

SSOs linked to Drinking Water Contamination: Cabool, MO

Between December 15, 1989, and January 20, 1990, residents of and visitors to Cabool, Missouri, experienced 243 cases of diarrhea and four deaths (Swerdlow et al. 1992). The CDC conducted a household survey and concluded that persons drinking municipal water were 18.2 times more likely to develop diarrhea than persons using private well water (Geldreich et al. 1992). Observations suggested that Cabool's SSS was prone to excessive storm water infiltration and therefore was unable to convey all of the wastewater to the treatment facility. As a result, frequent capacity-related SSOs occurred, spilling sewage onto the ground surface in areas over drinking water distribution lines and near water meter boxes. During the outbreak, the water distribution system was under construction, allowing untreated sewage to contaminate the drinking water system (Geldreich et al. 1992).

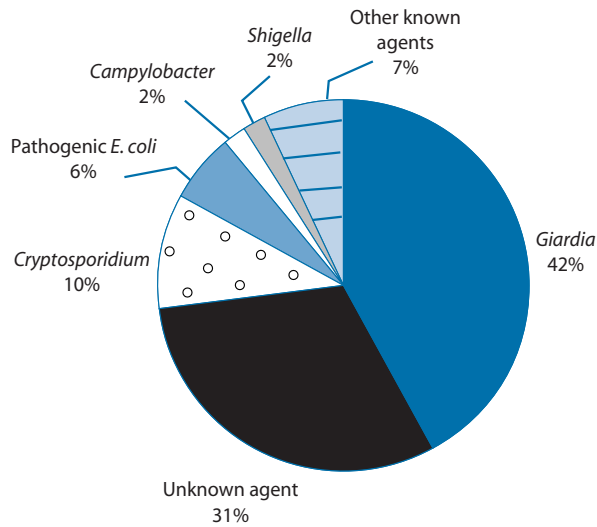

Figure 6.2

Microbial Pathogens Causing Outbreaks Linked to Drinking Water 1985 - 2000

Giardia was responsible for 42 percent of the outbreaks of waterborne disease linked to drinking water.

from rivers, streams, or lakes. Of these, EPA identified 11 outbreaks accounting for 7,764 cases of waterborne illness that CDC linked to drinking water contamination with sewage. Only one of these outbreaks was linked directly to CSOs or SSOs. The outbreaks were caused, however, by the types of microbial pathogens found in CSOs and SSOs. As shown in Figure 6.2, *Giardia*, which is present in significant concentrations in CSOs and SSOs, caused the largest number of outbreaks linked to drinking water. A summary of these outbreaks is provided in Appendix I.

Proximity of CSO Outfalls to Drinking Water Intakes

As described in Chapter 5 and documented in Appendix F, EPA geo-referenced more than 90 percent of all CSO outfalls. EPA compared the locations of these CSO outfalls to drinking water intakes. Only drinking water systems that serve a community on a year-round basis and that use surface water as the primary source of water were considered in this analysis. Approximately 7,519 such systems operate in the United States, of which 6,631 (85 percent) have been

In July 1998, a lightning strike and the subsequent power outage caused 167,000 gallons of raw sewage to flow into Brushy Creek in Texas (TDH 1998). The sewage contaminated municipal drinking water wells that supplied the community of Brushy Creek. Although the wells are not in direct contact with surface waters (the wells are more than 100 feet deep and encased in cement), drought conditions at the time are thought to have caused water from Brushy Creek to be drawn down into the aquifer and into the wells through a geologic fissure. It is estimated that 60 percent of Brushy Creek's population of 10,000 were exposed to *Cryptosporidium* and approximately 1,300 residents became ill with cryptosporidiosis. Residents of Brushy Creek were supplied water from the contaminated wells for approximately eight days (TDH 1998).

Drinking Water Contaminated by Sewage: Brushy Creek, TX

geo-referenced to the NHD and are included in this analysis.

All of the drinking water systems within one mile of any CSO outfall were selected for further analysis. As shown in Table 6.7, EPA identified seven states with outfalls located within one mile upstream of a drinking water intake. Phone interviews were conducted with both the NPDES permit-holder and drinking water authority in the identified areas to confirm the location of the CSO outfall, the status of the CSOs (active/inactive), and the location of the drinking water intake. In many cases, the NPDES permit-holder reported that the CSO was inactive, as a result of sewer separation or other CSO controls.

EPA identified and confirmed 59 active CSO outfalls within one mile of a drinking water intake. One NPDES-permit holder reported that receiving water modeling found that the drinking water intake (located within one mile, but on the opposite side of the river) was not affected by the CSO. Interviews with drinking water

authorities found, where a primary drinking water intake was located within one mile of an active CSO, each drinking water authority was aware of the CSO. Further, in all cases, lines of communication existed between the drinking water authority and the NPDES permit-holder. In many cases the drinking water authority indicated adjustments are made to the treatment process during wet weather.

This assessment indicates that CSO's generally do not pose a major risk of contamination to most public drinking water intakes. However, to understand the relationship between a discharge point and a downstream drinking water intake the transport and fate of the discharge between the two points must be modeled under the range of real world flow conditions for that stream reach. Such modeling is beyond the scope of this report.

6.2.3 Fish and Shellfish

Fish and shellfish are widely consumed in the United States and are a valued economic and natural resource (NYNJDEP 2002a). In 1995,

Table 6.7

Association of CSO Outfalls with Drinking Water Intakes

EPA identified 59 CSO outfalls in seven states with outfalls located within one mile upstream of a drinking water intake.

EPA Region	State	Number of CSO Outfalls within 1 mile upstream of a drinking water intake
1	ME	7
2	NY	7
3	PA	19
3	WV	9
4	KY	7
5	IN	3
5	OH	7
Total:		59

Note: EPA was unable to confirm data for an additional 14 outfalls in two states (PA and WV); these outfalls are not included in this table.

the most recent year for which data are available, 77 million pounds of clams, oysters, and mussels were harvested in the coastal United States (NOAA 1997). Shellfish grown in contaminated waters concentrate microbial pathogens and can have higher concentrations than the waters in which they are found. Viable pathogens can be passed on to humans by eating whole, partially cooked, or raw contaminated shellfish.

Reported Human Health Impacts

The World Health Organization reported that seafood is involved in 11 percent of all disease outbreaks from food ingestion in the United States (WHO 2001). The most common

illness associated with eating sewage-contaminated raw shellfish and fish is gastroenteritis (CERI 1999).

A review of CDC Surveillance Summaries identified eight waterborne disease outbreaks linked to the consumption of contaminated fish or shellfish for the period 1985-2000. These outbreaks resulted in 995 cases of illness (CDC 1990, 1995, 1996b, 1997). More information on these outbreaks is provided in Appendix I. In most cases, the contaminated fish or shellfish were exposed to or grown in sewage-contaminated water. Waste dumped overboard by boaters and improperly treated sewage were the most commonly cited sources of fish and shellfish contamination.

**Shellfish-Associated Illness:
New York State**

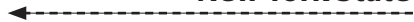

The New York State Department of Health compiled data on shellfish-associated illness (most commonly gastroenteritis) recorded in New York State from 1980 to 1999 (NYNJHEP 2002b). The incidence of reported illness has dropped markedly since its peak in 1982. The study was able to trace most of the outbreaks in 1982 to Rhode Island shellfish. The study noted that it is often difficult to identify the source of the shellfish that induced the outbreak. Decreases in shellfish-associated disease are attributed to a number of factors including: improvements in wastewater treatment leading to reductions in concentrations of waterborne microbial pathogens; more restrictions on shellfish harvesting in contaminated areas; and more public awareness of the risks associated with consuming raw shellfish. The study also noted that although shellfish beds are carefully monitored for pathogenic contamination, the levels of toxic contaminants in shellfish, including impacts from marine algal toxins, need additional study.

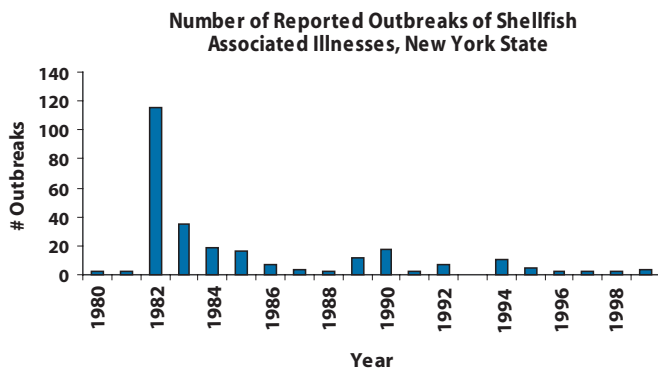

Direct links to CSO and SSO events as a cause of contamination were not made.

6.2.4 Direct Contact with Land-Based Discharges

Many SSOs discharge to terrestrial environments including streets, parks, and lawns. CSSs and SSSs can also back up into buildings, including residences and commercial establishments. These land-based discharges present exposure pathways that are different than those pathways associated with typical discharges to water bodies. Exposure to land-based SSOs and building backups typically occurs through dermal contact. The resulting diseases are often similar to those associated with exposure through drinking or swimming in contaminated water, but may also include illness caused by inhaling microbial pathogens (CERI 1999).

Reported Human Health Impacts

In general, very few outbreaks associated with direct contact with land-based SSOs have been documented. Land-based SSOs tend to leave visible evidence of their occurrence, such as deposits of sanitary products and other wastes commonly flushed down a toilet. The presence of these items often acts as a deterrent to direct contact with the SSO. Further, municipal response to land-based SSOs often includes cleaning the impacted area by washing the sewage into a nearby manhole or storm drain and disinfecting as needed. This review identified one confirmed outbreak resulting from direct contact with a discharge of untreated sewage in Ocoee, Florida.

This event resulted in 39 cases of hepatitis A (Vonstille 1993).

6.2.5 Occupational Exposures

Many occupational settings occasionally expose personnel to microbial pathogens. These include restaurants and food processing, agriculture, hospitals and healthcare, emergency response, and wastewater treatment.

Wastewater treatment plant workers and public works department personnel operate and maintain wastewater treatment facilities and respond to CSO or SSO events. In doing so, they may be exposed to microbial pathogens present in CSOs and SSOs. Police, firefighters, rescue divers, and other emergency response personnel also face exposure to CSOs and SSOs. Depending on the context in which the overflow event occurs, exposure can occur through inhalation, ingestion, and dermal contact. Adherence to good personal hygiene and the appropriate use of personal protective equipment are important in minimizing the potential for injury or illness.

Reported Human Health Impacts

Comprehensive epidemiologic research on waterborne illness associated with occupational exposure to untreated wastewater is lacking. Some researchers believe that wastewater workers may experience increased numbers of bacterial, viral, and parasitic infections without exhibiting signs or symptoms of illness. These are called “sub-clinical” infections (AFSCME 2003). One study concluded that the lowest rates

of illness are found among workers employed in wastewater treatment for less than five years, the highest rates in workers with five to 10 years of exposure, and lower rates again in workers with 15 years or more of exposure (Dowes et al. 2001). An explanation for this is that workers build immunity to many of the microbial pathogens present in the work environment over the course of their employment, and those who become very ill no longer work in the plant. This phenomenon is also known as the “healthy worker effect.”

In general, the effect of microbial pathogens, other than hepatitis A, on wastewater workers has been given little attention, and “there have been few epidemiologic studies conducted among sewage workers in the U.S. to determine the actual prevalence and types of infections” (AWR 2001).

One confirmed waterborne disease outbreak through occupational exposure was identified from the review of CDC Surveillance Summaries. In 1982, 21 cases of gastrointestinal illness were identified among 55 police and fire department scuba divers training in sewage-contaminated waters (CDC 1983). The divers developed gastrointestinal disease more than four times as frequently as nondiving firefighters, the control group in the study. Although the causes of illness in many divers were not identified, gastrointestinal parasites were found in 12 divers: *Entamoeba histolytica* in five divers, and *Giardia lamblia* in seven divers.

6.2.6 Secondary Transmission

An individual who contracts an infection from exposure to a waterborne microbial pathogen may, in turn, infect other individuals, regardless of whether symptoms are apparent in the first individual. This is commonly referred to as “secondary transmission.” The rate of secondary transmission depends largely on the particular microbial pathogen. Illnesses caused by secondary transmission are not included in CDC Surveillance Summaries, which list only primary illnesses.

Reported Human Health Impacts

Secondary transmission statistics obtained from a variety of waterborne and non-waterborne disease outbreaks are shown in Table 6.8 (NAS 1998). As presented, the secondary attack ratio represents the ratio of secondary cases to primary cases.

6.3 Which Demographic Groups Face the Greatest Risk of Exposure to CSOs and SSOs?

Several demographic groups face increased risk of exposure to the pollutants in CSOs and SSOs because they are more likely to spend time in locations impacted by such discharges. These groups include people recreating in CSO- and SSO-impacted waters, subsistence fishers, shellfishers, and wastewater workers. The sections that follow describe exposure risks for each of these groups in greater detail. This information is

Table 6.8

Examples of Secondary Transmission from Waterborne and Non-Waterborne Disease Outbreaks (NAS 1998)

An individual who contracts an infection may, in turn, infect other individuals. This table shows for every two individuals infected with Norwalk virus, one to two individuals can become infected via secondary transmission.

Microbial Pathogen	Secondary Attack Ratio	Source of Outbreak
Cryptosporidium	0.33	Contaminated apple cider
Shigella	0.28	Child day care center
Rotavirus	0.42	Child day care center
Giardia	1.33	Child day care center
Unspecified virus causing viral gastroenteritis	0.22	Contaminated drinking water
Norwalk virus	0.5 - 1.0	Contaminated recreational water

presented based on the availability of literature documenting each group’s potential for exposure, rather than on the relative sensitivity of each population to the pollutants in CSO and SSO discharges.

6.3.1 Swimmers, Bathers, and Waders

Swimming in marine and fresh water has been linked directly to diseases caused by the microbial pathogens found in wastewater (Cabelli et al. 1982). For example, a 1998 study comparing bathers and non-bathers found that 34.5 percent of gastroenteritis and 65.8 percent of ear infections reported by participants were linked to bathing in marine waters contaminated with sewage. The percentage of people who lost at least one day of normal activity due to contacting one of the illnesses studied ranged from 7 to 26 percent (Fleisher et al. 1998).

Many variables influence the exposure of people to pathogens in recreational water. These factors include whether people swim or wade, the type of pathogens present at the time of exposure, the route of exposure (ingestion or skin contact), and individual susceptibility to waterborne disease (WSDH 2002).

6.3.2 Subsistence and Recreational Fishers

Subsistence and recreational fishers and their families tend to consume more fish and shellfish than the general population, and men tend to consume more fish and shellfish than women (Burger et al. 1999). Further, in areas conducive to fishing, people with lower education levels or lower income levels consume more fish and shellfish, as it is often an inexpensive source of protein (Burger et al. 1999).

Cultural preferences influence the amount and frequency of fish as well as shellfish consumption and the methods for preparing and serving fish and shellfish. For example, a study of two Native American groups in Puget Sound in Washington found that these groups consumed fish at much higher rates than the general public and at rates greater than those recommended by EPA (Toy et al. 1996). Asians and Pacific Islanders generally consume fish at much higher rates than the general United States population (Sechena et al. 1999). In addition, cooking methods and consumption rates of parts of the fish that tend to concentrate toxins (e.g., skin, head, organs, and fatty tissue) can increase the risk of human health impacts from consuming

contaminated fish and shellfish (e.g., Wilson et al. 1998; WDNR 2003).

Fish and shellfish advisories target recreational and subsistence fishers. Despite warnings and advisories, however, many fishers consume their catch. May and Burger (1996) found that a majority of urban and suburban recreational fishers ignored warnings issued by the New York State Department of Health and the New Jersey Department of Environmental Protection.

6.3.3 Wastewater Workers

Wastewater workers are more likely to come into contact with untreated wastewater than the general public, but there is insufficient data to determine whether wastewater workers or their families face an increased risk of illness as a result of this exposure. Although there is disagreement regarding the benefits of additional immunization above those recommended by CDC for the adult general population (i.e., diphtheria and tetanus), WERF (2003b) asserts that wastewater workers should be vaccinated for both Hepatitis A and B.

6.4 Which Populations Face the Greatest Risk of Illness from Exposure to the Pollutants Present in CSOs and SSOs?

Certain demographic groups, including pregnant women, children, individuals with compromised immune systems, and the elderly, may be at greater risk than the general population for serious illness or a fatal outcome

resulting from exposure to the types of pollutants present in CSOs and SSOs. Specific characteristics of these demographic groups that make them particularly susceptible to these illnesses are discussed in more detail in the following sections. These sensitive groups represent almost 20 percent of the U.S. population (Gerba et al. 1996). Also, tourists and travelers may be more prone to waterborne illnesses than local residents (EPA 1983b). EPA research has found that when exposed to pathogens found in local sewage, local residents have been shown to develop fewer symptoms than non-residents or visitors.

6.4.1 Pregnant Women

During pregnancy, women appear to be at greater risk of more serious disease outcomes from exposure to the types of enteric viruses found in CSOs and SSOs (Reynolds 2000). Waterborne diseases contracted during pregnancy may result in transfer of the illness to the child either *in utero*, during birth, or shortly after birth (Gerba et al. 1996).

6.4.2 Children

The incidence of several waterborne infectious diseases caused by the types of pollutants present in CSO and SSO discharges is significantly greater in infants and children than in the general population (Laurenson et al. 2000). Factors contributing to the susceptibility of children include children's naturally immature immune systems and child-associated behaviors that result in abnormally high ingestion rates during recreational exposure to contaminated water (Laurenson et al. 2000). For example,

children frequently splash or swim in waters that would be considered too shallow for full-body immersion by adults (EPA 2001b).

6.4.3 Immunocompromised Groups

People with compromised immune systems, such as those with AIDS, organ transplant recipients, and people undergoing chemotherapy, are more sensitive than the general public to infection and illness caused by the types of pollutants present in CSO and SSO discharges (Gerba et al. 1996). Using Wisconsin death certificate data, Hoxie et al. (1997) analyzed cryptosporidiosis-associated mortality in AIDS patients following the 1993 Milwaukee outbreak that affected an estimated 403,000 people. The researchers found that AIDS was the underlying cause of death for 85 percent of post-outbreak cryptosporidiosis-associated deaths among residents of the Milwaukee area. Further, the researchers found that AIDS mortality increased significantly in the six months immediately after the outbreak, then decreased to levels lower than expected, and then returned to expected levels. This suggests that some level of premature mortality was associated with the outbreak.

6.4.4 Elderly

The elderly are at increased risk for waterborne illness due to a weakening of the immune system that occurs with age (Reynolds 2000). Studies have found that people over 74 years old, followed by those between 55 and 74, and then by children under

5, respectively experience the highest mortality from diarrhea as a result of infection by waterborne or foodborne illness (Gerba et al. 1996). Studies of a giardiasis outbreak in Sweden that occurred when untreated sewage contaminated a drinking water supply found people over 77 years old faced an especially high risk of illness (Ljungstrom and Castor 1992).

6.5 How are Human Health Impacts from CSOs and SSOs Communicated, Mitigated, or Prevented?

A variety of programs are in place to reduce human health impacts associated with exposure to microbial pathogens and toxics. These programs generally involve preventive measures enacted by public health officials, including: communication efforts to warn the public about risk and threats; and monitoring, reporting, and tracking activities. This section is focused on agencies, activities, and programs designed to communicate, mitigate, or prevent potential human health impacts from exposure to CSOs and SSOs.

6.5.1 Agencies and Organizations Responsible for Protecting Public Health

Numerous agencies and organizations have responsibilities for monitoring, tracking, and notifying the public of potential human health impacts. These include federal and state agencies, local public health officials, owners and operators of municipal wastewater

collection and treatment facilities, and non-governmental organizations.

Federal Agencies

EPA administers a national water quality standards program that establishes criteria to support designated uses including recreation, drinking water supply, and shellfish harvesting. EPA also administers a national safe drinking water program with a goal that, by 2005, 60 percent of the population served by community drinking water systems will receive their water from systems with active source water protection programs (EPA 1997b). In developing source water protection programs, EPA specifically encourages suppliers to consider CSOs, sewer system failures, and wet weather municipal effluent point source discharges as sources of microbial contamination. Further, drinking water intakes and their designated protection areas are identified as “sensitive areas” under the CSO Control Policy. The elimination, control, or relocation of CSO outfalls that discharge to sensitive areas are to be given high priority in the development and implementation of CSO LTCPs (EPA 1994a).

As discussed earlier in Section 5.5.2 of this report, EPA’s BEACH program conducts an annual survey of the nation’s swimming beaches. The program was created to reduce health risks to swimmers due to contact with contaminated water by working to improve monitoring and public notification procedures at beaches.

CDC’s National Center for Infectious Diseases works to prevent illness, disability, and death caused by

infectious diseases. Waterborne disease prevention is a priority for this program. Working with EPA, CDC coordinates national reporting of waterborne illness outbreaks through its Outbreak Surveillance System. This system compiles state-reported outbreaks to characterize waterborne outbreaks epidemiologically (e.g., to investigate the agents, reasons for the outbreak, and adequacy of various treatment methods) and to strengthen the public health community’s ability to respond. Outbreak summaries are produced biennially. With the cooperation of state health departments and other national partners, CDC’s Division of Parasitic Diseases and Division of Bacterial and Mycotic Diseases are responsible for the investigation, surveillance, and control of specific groups of diseases, including many pathogens linked to waterborne illness.

NOAA works to protect and preserve U.S. living marine resources through scientific research, fisheries management, enforcement, and habitat conservation. As detailed in Section 5.3.2 of this report, NOAA is currently working with Interstate Shellfish Sanitation Conference (ISSC), EPA, and FDA to develop an information resource on shellfish safety. This data system will house shellfish growing area monitoring, survey, and classification data.

FDA administers the National Shellfish Sanitation Program, an effort intended to standardize the inspection and monitoring of shellfish growing areas and shellfish packing/shucking facilities. Working with EPA, FDA

publishes guidance on the safety attributes of fish and fishery products, including acceptable levels of organic and inorganic compounds such as mercury and PCBs.

USGS plays an active role in monitoring and reporting the quantity and quality of the nation's water resources. USGS helps to assess water quality problems and sources of pollution, including CSOs and SSOs, by studying how pathogens and other agents of waterborne disease interact with the environment and by monitoring and reporting the quality of the nation's water resources.

State Agencies

State public health agencies track communicable diseases, perform outbreak investigations, and issue warnings to the public. These agencies integrate and compile findings from local efforts, and they provide

coordination with other state and federal agencies and programs. This coordination includes providing data on waterborne illness and investigations to CDC.

State environmental agencies conduct water quality monitoring and assessment programs and require monitoring to be conducted by others, such as local sanitation districts, public water systems, regional planning agencies, and recreational facilities. State environmental or natural resource agencies also monitor fish and shellfish. These monitoring programs provide data for management decisions at the state level in response to environmental and public health concerns. In addition to monitoring, state agencies perform sanitary surveys to identify problems that could affect the safety of the drinking water supply. A sanitary survey is a physical inspection of the

Coastal Beach Monitoring Program: Connecticut

The State of Connecticut has a comprehensive monitoring program for its coastal waters, with standards and guidelines set by the state. The state collects and analyzes samples taken at four coastal state parks on Long Island Sound. At least 18 municipalities in the state's four coastal counties monitor their own beaches, following the ocean and bay beachwater-quality monitoring protocol established by the Connecticut Departments of Public Health and Environmental Protection. In 2002, Connecticut set aside a \$226,000 grant to integrate monitoring at municipal beaches into a state-administered sampling and public notification plan for the entire state. The beach grant funded a courier service to bring municipal beach samples to the Department of Public Health lab, where the state analyzes the samples free of charge.

Beach Monitoring and Public Notification Program: Rhode Island

The Rhode Island Health Department requires every licensed beach to sample its water and test for the presence of fecal coliform bacteria. The Rhode Island water quality standard for recreation is 50 MPN per 100 ml of salt water and 200 MPN per 100 ml of fresh water. Results are posted on the department's website, along with advisories on waterborne illness and beach closures and openings. Public notification of beach closures is accomplished in several ways, including the use of color-coded flags at beaches, press releases, and notices on the department website. The website also supports on-line reporting by the public of suspected beach-related illnesses.

water treatment and distribution system and a review of operation and maintenance practices.

States also implement notification programs to warn citizens about human health impacts associated with recreation at contaminated beaches and consumption of contaminated water, fish, or shellfish.

Local Agencies

Local public health agencies, regional planning authorities, and the owners and operators of wastewater collection and treatment facilities have distinct responsibilities to protect public health. Working with state oversight, city and county health departments often maintain separate divisions for tracking communicable diseases and for environmental health. The communicable disease divisions of these departments generally have responsibility for cataloging, investigating, and reporting cases of “reportable illness” to the appropriate state agency. The environmental

health divisions generally have responsibility for monitoring, analysis, and posting of recreational waters, where needed. Owners and operators of municipal wastewater collection and treatment facilities have their own responsibilities, many of which are stipulated as NPDES permit requirements, including notifying the public when SSOs occur and reporting SSOs to state regulatory and public health agencies. Communities with CSSs are required to implement public notification programs as part of implementing the NMCs.

6.5.2 Activities to Protect Public Health from Impacts of CSOs and SSOs

The principal activities undertaken to protect the public from the impacts of CSOs and SSOs can be grouped into three areas: exposure pathway monitoring, public notification, and research. These activities protect public health by identifying possible sources of pathogens, reducing public exposure through notification and

In California, the Orange County Health Care Agency’s Ocean Water Protection Program has a mission to ensure that all public recreational waters meet bacteriological water quality standards for full body contact recreation activities, such as swimming, surfing, and diving. Staff collect water samples at approximately 150 locations along the shoreline of Orange County for laboratory analysis for indicator bacteria. Results of the analysis are reviewed by program specialists who determine if action needs to be taken to protect the public. Staff are available to respond on a 24-hour basis to investigate reports of contamination incidents, including SSOs, affecting Orange County’s public beaches.

Local Public Health Activity: Orange County, CA



The Allegheny County Health Department in Pennsylvania implemented a public notification program designed to warn recreational users of health risks in CSO-impacted waters in the Pittsburgh area. The program includes publishing advisories in local newspapers and producing public service announcements on local television stations to educate the public about health risks associated with CSO discharges. The department also installed orange warning flags that read “CSO” at 30 locations near CSO outfalls. The flags are raised to warn recreational users whenever CSO discharges cause or contribute to elevated bacteria levels.

Local Public Health Activity: Allegheny County, PA



use restriction, when necessary, and continuing research by public health experts to better protect public health in the future. More detail on each activity is presented below.

Exposure Pathway Monitoring

Exposure pathway monitoring programs focus on recreational waters, public drinking water systems, and fish and shellfish in order to reduce the risk of human health impacts from exposure to contaminated water and food.

Recreational waters are typically monitored using indicator bacteria to detect the presence of or the potential for microbial pathogen contamination. If the bacteria levels in a given water sample exceed the state standard for recreational waters, advisories are posted or the waterbody is closed. For example, EPA's 2002 BEACH Program found that 91 percent of surveyed beaches had some type of water quality monitoring program. Though the frequency of monitoring varied, 63 percent of the beaches were monitored at least once per week (EPA 2003a).

Public water systems are governed by National Primary Drinking Water Standards, also known as primary standards (EPA 2003f). Primary standards are legally enforceable standards that protect public health by limiting the levels of specific contaminants in drinking water. To protect the health of those being served, public water systems have monitoring requirements. Contaminants monitored are as follows (EPA 2002f):

- Microorganisms including indicator organisms, enteric viruses, and parasitic protozoa;
- Disinfectants including chlorine, chlorine dioxide, and chloramine;
- Disinfection byproducts including bromate, chlorite, haloacetic acids, and trihalomethanes;
- Inorganic chemicals including metals, nitrate, and nitrite;
- Organic chemicals including a broad list of agricultural and industrial products; and
- Radionuclides.

If monitoring shows the drinking water is contaminated, the owner or operator of the public water system is required to shut down the system and/or direct the public to take precautions, such as boiling water.

Fish and shellfish monitoring is administered jointly by state agencies, EPA, NOAA, and FDA. Bacteriological monitoring is used to assess the potential presence of microbial pathogens in shellfish harvesting areas. States, U.S. territories, and authorized tribes have primary responsibility for protecting residents from the health risks of consuming contaminated, noncommercially caught fish. This is accomplished by issuing of fish consumption advisories. These advisories inform the public when high concentrations of contaminants have been found in local fish. They also include recommendations to limit or avoid eating certain fish species from specific waterbodies or waterbody types.

Public Notification

Public notification programs provide information to communities regarding the occurrence of CSO and SSO events and ongoing efforts to control discharges.

Public notification programs include posting temporary or permanent signs where CSOs and SSOs occur, coordinating with civic and environmental organizations, and distributing fact sheets to the public and the media. Notices in newspapers are used to publicize CSO or SSO discharges in some states. Radio and television announcements may be appropriate for CSOs and SSOs with unusually severe impacts. Distribution of information on websites is rapidly gaining wider use. Additional information on reporting and public notification is presented in Chapter 8 of this Report to Congress and in the technology descriptions included as Appendix L.

Research

Several research activities are expected to improve the ability of public health programs to protect humans from impacts associated with CSOs, SSOs, and other sources of pollution. Two examples are provided below.

EPA's National Epidemiological and Environmental Assessment of Recreational (NEEAR) Water Study is intended to develop a better understanding of water pollution at beaches, recreational use of beaches, and public health. As part of the BEACH Program, this effort seeks to improve beach monitoring by linking real-time monitoring results with meaningful risk-based guidelines.

EPA's Office of Research and Development has completed the first in a planned series of studies to estimate the urban contribution to the total *Cryptosporidium* and *Giardia* loads to receiving waters (EPA 2003f). It is hoped that the studies will provide a basis for designing source water protection programs.

6.6 What Factors Contribute to Information Gaps in Identifying and Tracking Human Health Impacts from CSOs and SSOs?

Systematic data on human health impacts as a result of exposure to CSOs and SSOs are not readily available. The chief factors that account for the absence of direct cause-and-effect data

In 1984, public drinking water for the community surrounding Braun Station, Texas, was drawn from an artesian well that was not filtered but was chlorinated prior to distribution. At the time, well water was not routinely sampled in this region of Texas. Community complaints, however, convinced authorities to begin testing. Fecal coliform level as high as 2,600/100 mL were measured in untreated well water samples. Subsequent dye tests indicated that the community's SSS was leaking into the well water. When attempts to identify the exact site of contamination were not successful, an alternative water source was provided to the community (D'Antonio et al. 1985).

Monitoring Identifies SSS as Source of Drinking Water Contamination: Braun Station, TX



are underreporting of waterborne disease and the reliance of water quality monitoring activities on indicator bacteria instead of microbial pathogens. Both factors are discussed below.

6.6.1 Underreporting

Reporting and tracking of outbreaks of waterborne disease are difficult under the best circumstances.

Underreporting stems from a number of causes. CDC's waterborne disease outbreak surveillance system depends on states to report outbreaks, and this reporting is often incomplete. Existing local systems for tracking these outbreaks often lack sufficient information on the cause of the outbreak to establish whether CSOs and SSOs are suspected source.

Factors that affect the likelihood that outbreaks will or will not be detected, investigated, and reported include (adapted from CDC 2000):

- Public awareness about illness symptoms, environmental conditions that might precipitate an outbreak, and where to report symptoms;
- The frequency with which people experiencing illnesses related to exposure to contaminated water seek medical care from the same provider;
- The adequacy of laboratory infrastructure to fully investigate outbreaks;
- The compatibility of local reporting requirements for specific waterborne diseases with data

tracking systems employed by the CDC; and

- The integration of state and local reporting and investigation protocols for waterborne disease outbreaks.

Large outbreaks are more likely to be noticed and reported than smaller outbreaks. Nevertheless, the source and exposure pathway of the 1993 Milwaukee cryptosporidiosis outbreak, the largest documented in U.S. history, remained unidentified for more than two weeks (CDC 1996a). This outbreak, affecting an estimated 403,000 people, was detected only “when increased sales of antidiarrheal medicines were observed and reported to the local public health agency” (Frost et al. 1995).

6.6.2 Use of Indicator Bacteria

Indicator bacteria are used to evaluate human health risks from contaminated water without sampling for every possible microbial pathogen. As described in Section 6.1.1, indicator bacteria are relatively easy to detect and are used to indicate the likely presence of fecal-borne microbial pathogens. There is ongoing scientific debate regarding the use of indicators and their ability to predict human health impacts. Some specific criticisms of the use of indicator bacteria are as follows:

- A single indicator organism may be insufficient to establish water quality standards. EPA's current water quality criteria are targeted toward protecting people participating in

recreational activities from acute gastrointestinal illness (EPA 2002g).

- Current bacterial detection methods are subject to false positives and false negatives (Griffin et al. 2001).
- Coliform bacteria can survive and replicate in waters and soils under certain environmental conditions. Their presence is not always due to recent fecal contamination. In addition, all current bacteria indicators are shed by animals. Their occurrence in the environment does not always indicate that human pathogens are present or that contamination was due to a human source (Griffin et al. 2001).
- Indicator bacteria do not directly indicate the presence of viruses, which survive longer in marine waters and have a low infective dose (Seyfried et al. 1984; Freeman 2001; Schvoerer et al. 2001).

Bacteriophages have shown merit for use as an alternative to indicator bacteria to identify human health risks. Specifically, *Bacteroides fragilis* bacteriophages have been found to be more resistant to chlorine than current indicator bacteria and are thought to be good indicators of enteric viruses. *Bacteriodes* also show potential for use as an indicator of recent fecal contamination (Griffin et al. 2001).

Although EPA recognizes the limitations of indicator bacteria, they continue to be used to assess potential human health risk because:

- Indicator bacteria are simple and inexpensive to measure (Griffin et al. 2001).
- Studies show that *E. coli* and enterococci exhibit a strong relationship to swimming-associated gastrointestinal illness (Fattal et al. 1987; Cheung et al. 1990; EPA 2002g).
- Indicator bacteria are present where fecal contamination occurs; they are always present in feces and at higher levels than most enteric pathogens (Griffin et al. 2001).

EPA continues to encourage states and authorized tribes to use *E. coli* or enterococci as the basis of their water quality criteria for protecting recreational waters.

6.7 What New Assessment and Investigative Activities are Underway?

Several local government agencies are implementing innovative programs to identify risks and to track the types of illness associated with the pathogens present in CSO and SSO discharges. Select examples are provided in this section.

6.7.1 Investigative Activities

Monitoring, modeling, and other investigative activities are useful tools in reducing human exposure to pathogens, identifying waterborne and foodborne disease outbreaks, and assessing illness patterns. Some innovative investigative programs

intended to reduce human health impacts and risk are described below.

- In Texas, the Austin-Travis Health and Human Services Department has a predictive model for recreational water quality at the Barton Springs pool. If the Barton Creek watershed receives more than one inch of rainfall, the pool is closed until monitoring determines it is safe to reopen (Staudt 2002).
- New York City has an advanced rainstorm modeling system that predicts the estimated amount of fecal matter that will contaminate beaches after a measurable rainfall. This information is used to make decisions on beach closures and is shared with all area beaches and neighboring states (Luke 2002).
- Orange County, California, maintains a passive reporting system for illnesses from recreational waters. Between 1998 and 2002, Orange County received 110 ocean and bay bather illness reports and one illness report from a freshwater lake (Mazur 2002).
- Boston, Massachusetts, operates a waterborne surveillance project that monitors *Cryptosporidium* and *Giardia* illnesses from drinking water. The program uses fixed populations within the city (schools, nursing homes, prisons) as control groups (Gurba 2002).
- San Diego County, California Department of Environmental Health and a group called Surfers Tired of Pollution conducted a self-reported ocean illness survey. Between August 1, 1997, and December 31, 1999, 232 illnesses were reported. The county plans a second survey (Clifton 2002).
- The Douglas County, Nebraska Health Department compares reported illnesses with a computer model that provides epidemiologic analysis for 1- to 10-year periods. Reported illnesses are compared with projected baselines and trends to determine if an outbreak is occurring (Kurtz 2002).
- New York City has an active outbreak monitoring procedure. The Department of Health tracks reports of giardiasis and cryptosporidiosis by visiting labs in New York City on a weekly basis and making sure all samples testing positive for the pathogens are reported. The Department of Health receives weekly tallies of diarrheal medicine sold in the area and has a clinical lab monitoring system to track the number of stool samples tested. Finally, the city monitors hospital emergency rooms for the number of people complaining of diarrhea and vomiting (Seeley 2002).

Chapter 7

Federal and State Efforts to Control CSOs and SSOs

The federal and state regulatory framework for controlling CSOs and SSOs affects municipal decision-making on how to best protect human health and the environment from these discharges. This chapter describes the status of the federal framework used to address CSOs and SSOs. The discussion on CSO policies summarizes findings from the 2001 *Report to Congress—Implementation and Enforcement of the CSO Control Policy* (EPA 2001a) and updates data on the status of NPDES permit requirements for CSO control. A brief discussion of current SSO regulatory efforts follows. This chapter also describes a number of state programs to address CSOs and SSOs, and it presents an overview of federal compliance assistance and enforcement efforts related to CSOs and SSOs.

7.1 What are States and EPA Regions Doing to Control CSOs?

On April 19, 1994, EPA published the CSO Control Policy that established objectives for CSO communities and expectations for NPDES permitting authorities (59 FR 18688). The CSO Control Policy also presented elements of an enforcement and compliance program to address dry weather CSO discharges and to enforce NPDES permit requirements. The four key principles of the CSO Control Policy that ensure that CSO controls are cost-effective and meet the objectives of the Clean Water Act are:

1. *Provide clear levels of control that would be presumed to meet appropriate health and environmental objectives;*

In this chapter:

- 7.1 What are States and EPA Regions Doing to Control CSOs?
- 7.2 What are States and EPA Regions Doing to Control SSOs?
- 7.3 What Programs Have Been Developed to Control SSOs?
- 7.4 What Compliance and Enforcement Activities Have Been Undertaken?

2. *Provide sufficient flexibility to municipalities, especially financially disadvantaged communities, to consider the site-specific nature of CSOs and to determine the most cost-effective means of reducing pollutants and meeting [Clean Water Act] objectives and requirements;*
3. *Allow a phased approach to implementation of CSO controls considering a community's financial capability; and*
4. *Provide for review and revision, as appropriate, of water quality standards and their implementation procedures when developing CSO control plans to reflect the site-specific wet weather impacts of CSOs.*
5. Prohibition of CSOs during dry weather
6. Control of solids and floatable materials in CSOs
7. Pollution prevention
8. Public notification to ensure that the public receives adequate notification of CSO occurrences and CSO impacts
9. Monitoring to effectively characterize CSO impacts and the efficacy of CSO controls

Objectives for CSO communities with NPDES permits are 1) to implement the NMC and submit documentation on NMC implementation; and 2) to develop an LTCP.

7.1.1 Nine Minimum Controls

The NMC are:

1. Proper operation and regular maintenance programs for the sewer system and the CSOs
2. Maximum use of the collection system for storage
3. Review and modification of pretreatment requirements to assure CSO impacts are minimized
4. Maximizing flow to the POTW for treatment

Municipalities were expected to implement the NMC and to submit appropriate documentation to NPDES authorities as soon as reasonably possible, but no later than January 1, 1997. Of the 828 active CSO permits identified by EPA in July 2004, 94 percent (777 permits) required implementation of the NMC.

7.1.2 Long-Term Control Plans

In addition to implementing the NMC, CSO communities are expected to develop and implement an LTCP that includes measures to provide for attainment of water quality standards. The policy identified nine elements that an LTCP should include:

- Characterization, monitoring, and modeling of the CSS
- Public participation
- Consideration of sensitive areas
- Evaluation of alternatives
- Cost/performance considerations
- Operational plan

- Maximization of treatment at the POTW treatment plant
- Implementation schedule
- Post-construction compliance monitoring

LTCP implementation schedules were expected to include project milestones and a financing plan for design and construction of necessary controls as soon as practicable (EPA 1994a).

In July 2004, EPA confirmed the status of LTCPs with states and regional NPDES authorities:

- 86 percent (708 of 828) of permits required development and implementation of an LTCP;
- 59 percent (490 of 828) of LTCPs have been submitted; and
- 35 percent (290 of 828) of LTCPs have been approved.

More information on the CSO Control Policy is provided in EPA's 2001 *Report to Congress—Implementation and Enforcement of the CSO Control Policy*.

7.2 What are States and EPA Regions Doing to Control SSOs?

SSOs that reach waters of the United States are point source discharges, and, like other point source discharges from SSSs, are prohibited unless authorized by an NPDES permit. Moreover, SSOs, including those that do not reach waters of the United States, may be indicative of improper operation and

maintenance of the sewer system, and thus may violate NPDES permit conditions.

7.2.1 Application of Standard Permit Conditions to SSOs

The NPDES regulations establish standard permit conditions that are incorporated into all NPDES permits. Several existing standard permit conditions have particular application to SSOs. These include:

Noncompliance Reporting – When incorporated into a permit, the standard permit conditions for noncompliance reporting at 40 CFR 122.41(l)(6) and (7) require permittees to report any instance of noncompliance to the NPDES authority. Unpermitted discharges from SSSs to waters of the United States constitute noncompliance, which the permittee would report under these provisions.

Recordkeeping – The permit provisions required by 40 CFR 122.41(j)(2) require permittees to retain copies of all reports required by the permit for a period of at least three years from the date of the report. This provision would require retention of records of noncompliance reports of SSOs.

Proper Operation and Maintenance Requirements – The standard permit conditions at 40 CFR 122.41(d) and (e) require proper operation and maintenance of permitted wastewater systems and related facilities to achieve compliance with permit conditions and that permittees take all reasonable



SSOs can occur at numerous locations in the sewer system, including at manholes.

Photo: EPA

Table 7.1

Summary of Electronic SSO Data by State

At a minimum, states with electronic systems for tracking SSOs compile information on the date, location, or cause of the overflow.

steps to minimize or prevent any discharge in violation of the permit that has a reasonable likelihood of adversely affecting human health or the environment. In a permit for a wastewater treatment facility and/or a sewer system, these two standard conditions would require the permittee to properly operate and maintain its collection system as well as take all reasonable steps to minimize or prevent SSO discharges.

7.2.2 Electronic Tracking of SSOs

A growing number of states have increased data collection and tracking efforts for SSOs (excluding building backups) in recent years. As part of this report effort, EPA identified 25 states that track SSO data electronically. The states and the most commonly tracked SSO data elements are listed in Table 7.1.

State	Date & Time Reported	Start Date & Time	End Date & Time/ Duration	Total Overflow Volume (gallons)	SSO Location ^a	SSO Cause	Response Measures Taken ^b	Receiving Water Identified
CA	●	●	●	●	●	●	●	●
CO	●	●	●	●	●	●	●	●
CT		●	●	●	●	●		
FL		●		●	●	●		●
GA	●	●		●	●			●
HI	●	●	●	●	●	●	●	●
IN		●	●	●	●	●		
KS		●	●		●			
MA	●	●	●	●	●	●	●	●
MD		●	●	●	●	●		●
ME	●	●	●	●	●	●	●	●
MI	●	●	●	●	●	●	●	●
MN	●	●	●	●	●	●	●	
NC		●	●	●	●	●		●
ND	●	●	●	●	●	●	●	●
NH	●	●	●	●	●	●	●	●
NV	●	●		●	●	●	●	●
OK		●	●	●	●	●	●	
RI	●	●	●	●	●	●	●	●
SC	●			●	●			●
SD	●	●	●	●	●	●	●	●
UT						●		
WA		●		●	●	●	●	●
WI		●	●	●	●	●	●	●
WY		●				●	●	●

^a May not include exact SSO location point

^b May include cleanup activities, volume recovered, and corrective or preventive measures

SSO Data Publication via the Internet

Maryland and Michigan publish CSO and SSO data periodically on the Internet. In Maryland, owners or operators of an SSS must report any SSO that results in a discharge of raw or diluted sewage into the waters of the state to the Maryland Department of the Environment (MDE). This requirement is also applicable to CSOs and wastewater treatment plant bypasses. MDE coordinates reporting requirements with local health departments. Reports must include the volume spilled, duration, start and stop times, name of receiving waters, cause, corrective action taken, and information regarding public notification. CSO and SSO data reported to MDE can be found at http://www.mde.state.md.us/programs/waterprograms/cso_sso.asp.

The Michigan Department of Environmental Quality (MDEQ) has broad statutory and regulatory authority for SSOs under Part 31, Water Resources Protection, and Part 41, Sewerage Systems, of the Natural Resources and Environmental Protection Act, 1994 PA 451, as amended. Facilities in Michigan are required to notify MDEQ within 24 hours of when a CSO or SSO discharge begins. After the discharge ends, the facility must submit a complete report, including the location and volume of the discharge as well as the start/end date and time.

MDEQ's CSO and SSO discharge information web page provides specific event information on CSOs and SSOs (<http://www.deq.state.mi.us/csosso/>). In addition to providing final CSO and SSO reports, MDEQ's

website also displays records of recent events for which MDEQ has not yet received a final written report. Recently, MDEQ produced its first *Combined Sewer Overflow (CSO) and Sanitary Sewer Overflow (SSO) Report*, which compiled event information during the period from July 2002 to December 2003. MDEQ expects that subsequent reports will be made available on a calendar-year basis.

7.3 What Programs Have Been Developed to Control SSOs?

Although there is no national regulatory program specific to SSOs, a number of EPA regions and state agencies have initiated efforts to address SSOs. Some agencies require that permittees assess sewer system condition or implement specific O&M practices. Other agencies have implemented programs requiring sewer system owners to obtain NPDES permit coverage, whether or not they operate a wastewater treatment facility. The following descriptions are not intended to be comprehensive, but represent some innovative approaches to addressing SSO issues.

7.3.1 EPA Region 4's MOM Program

EPA Region 4's Management, Operations, and Maintenance (MOM) Program is implemented in cooperation with states in the region. The MOM program encourages all NPDES permit-holders and any associated satellite utilities to participate in a proactive approach to managing, operating, and maintaining their sewer system. Utilities that

implement good MOM Programs benefit by reducing the likelihood of Clean Water Act violations, extending the life of their infrastructure, and providing better customer service through steady rates and greater efficiency. The goal of the MOM Program is to bring 100 percent of the POTWs handling domestic wastewater in Region 4 into compliance with the “proper operation and maintenance” provision of their NPDES permits by 2011.

The Region 4 MOM Program addresses SSO issues in sewer systems (including satellites) by concentrating on high priority watersheds. Region 4 uses a Geographic Information System (GIS) to focus on watersheds categorized as having existing water quality problems or assessed as being vulnerable to stressors (e.g., coastal and shellfish harvesting areas). Based in part on recommendations made by states in the region, Region 4 selects at least one watershed in each state for each cycle of the MOM Program. Region 4 started the second cycle of its MOM Program in September 2003.

In the selected watersheds, the operators of all sewer systems are expected to provide a self-evaluation report to the region. This report identifies improvements that can be made and the schedules necessary to make those improvements. Region 4 encourages participants to conduct the self-evaluation within seven months of receiving the initial requests. To assist participants with the process, Region 4 provides checklists and other outreach information. Depending on the thoroughness of the self-evaluation, Region 4 may conduct follow-up inspections and initiate further

discussions regarding the evaluated programs. Where the permittee does not conduct an evaluation, Region 4 conducts its own site inspection. Through voluntary participation in the program and by self-disclosing any needed improvements, participants may be eligible for a reduction in civil penalties while under a remediation schedule.

Region 4 expects participants to develop a plan that addresses the MOM requirements, which the region typically includes in a Letter of Violation (LOV) or an AO. Region 4 recently completed the first round of LOV inspections and found that many MOM Program participants have made significant positive and productive efforts (e.g., increased staff, purchased maintenance equipment, and increased cleaning frequency) toward the development and implementation of their MOM Programs.

7.3.2 Oklahoma – Collection System Program

The Oklahoma Department of Environmental Quality (ODEQ) has actively addressed SSO and sewer system issues for many years through its NPDES program. Program elements include permitting, compliance, enforcement, and education/outreach.

Standard NPDES permit language in Oklahoma requires proper O&M of the sewer system and reporting of bypasses and SSOs. A state construction permit, which is distinct and different from an NPDES permit, is required for all new sewer lines to ensure that the sewer system has

adequate capacity to accommodate the growth. When a request is made to ODEQ to expand an SSS, the capacity of pipes, pumps, and other system components is evaluated by ODEQ design and engineering staff during review of the construction permit. These requirements encourage municipalities to have a program in place to address capacity, management, operation, and maintenance issues in their sewer system.

ODEQ evaluates system performance through compliance evaluation inspections, complaint and fish kill investigations, and database record reviews. Members of the general public can report SSOs by calling an ODEQ overflow hotline; ODEQ investigates all complaints of alleged SSOs. Oklahoma's criterion for significant non-compliance due to SSOs is more than one SSO at the same location in a 12-month period. As of 2003, ODEQ has 60-70 active enforcement orders for SSOs.

ODEQ has maintained an SSO database and tracking system since 1987. Over the last 15 years, the annual number of reported SSO events has decreased by 14 percent, and the number of enforcement orders issued annually has decreased by approximately 25 percent. During this same period, the number of municipalities reporting at least one SSO event has increased by 12 percent. ODEQ attributes the increase in the number of systems reporting SSOs to elevated awareness of SSO issues by the regulated community and the public. ODEQ's education and outreach efforts include operator certification training, ODEQ-

sponsored seminars, and staff presentations to municipal leagues, rural water associations, regulated communities, and other affected groups.

7.3.3 California – Record Keeping and Reporting of Events

Some of California's Regional Water Quality Control Boards (RWQCBs) use Waste Discharge Requirements (WDR), a form of discharge permit, to address SSOs. These orders prohibit all discharges of wastewater from a sewer system upstream of a wastewater treatment plant. Priorities in California are to address beach closures linked to SSOs, such as those occurring in Orange County, San Diego, and Los Angeles.

The RWQCB Orders require proper O&M, sewer system management plans, capacity evaluations, and FOG programs. For example, in May 1996, the San Diego RWQCB adopted Order No. 96-04 prohibiting SSOs. This order was adopted as a mechanism to achieve a reduction in the number and volume of SSOs and to protect water quality, the environment, and public health. Order No. 96-04 also brings satellite sewer systems under a regulatory framework. The order regulates 48 cities and special districts in the San Diego area that own and operate SSSs. It also requires a monitoring and reporting program with specific SSO reporting procedures.

In addition, California has a statewide regulation requiring utilities to report SSOs greater than or equal to 1,000 gallons and all SSOs that reach surface waters. Reports must be made within



Advisory and closing signs are posted at beaches throughout Orange County, CA, to alert beachgoers of potential dangers, from elevated bacterial levels.

Photo: OCHA Ocean Water Protection Program.

24 hours of becoming aware of the spill and followed up with a written report within five days. The RWQCBs have issued several large penalty orders for SSOs (generally one dollar per gallon spilled).

7.3.4 North Carolina – Collection System Permitting

In 1999, the North Carolina General Assembly ratified HB 1160 (1999 NC Sessions Laws Chapter 329), a bill that requires SSSs to obtain a comprehensive permit separate from the NPDES permit obtained by wastewater treatment facilities. The North Carolina Department of Environment and Natural Resources (NCDENR) administers this permitting program through the Non-Discharge Permitting Branch in coordination with the Enforcement Group. The focus of the NCDENR program is proactive, preventive O&M of sewer systems.

NCDENR collection system permits contain five principal sections: performance standards, O&M, inspections, record keeping, and general conditions. Conditions are included for grease control, planned reinvestment in the SSS through a capital improvement plan, alarms for pump stations, spare parts, inspections, cleaning, mapping, observation, and preventive maintenance. The permits also include public notification and other reporting requirements. NCDENR has provided guidance for reporting SSOs that includes a standardized calculation for estimating the volume of SSOs when they occur.

NCDENR is using a phased approach to permit all SSSs over a five-year period (20 percent/year). This program incorporates a number of older satellite systems that have never been permitted. The first round of permits was issued in 2001. Sewer systems that fail to meet the standard permit conditions may be subject to enforcement action by NCDENR. The 1999 legislation dramatically increased the potential civil penalties that may be assessed against the municipality for unauthorized discharges (G.S. 143-215.6A).

7.4 What Compliance and Enforcement Activities Have Been Undertaken?

The goal of EPA's water compliance and enforcement program is to ensure compliance with the Clean Water Act. EPA's compliance and enforcement program has five major objectives:

- Provide compliance assistance tools and information to the regulated community;
- Identify instances of noncompliance;
- Return violators to compliance;
- Recover any economic advantage obtained by the violator's noncompliance; and
- Deter other regulated facilities from noncompliance.

EPA established "wet weather" (i.e., CSOs, SSOs, storm water, and concentrated animal feeding operations) as a national enforcement priority for FY 2002 and FY 2003.

The compliance and enforcement policies and strategies used to address CSOs and SSOs are discussed in the following subsections. In addition, a summary of related enforcement actions as of October 2003 is presented.

7.4.1 National Municipal Policy on POTWs

EPA's 1984 *National Municipal Policy on Publicly-Owned Treatment Works* (NMP) provided an impetus for control of all discharges from municipal sewer systems, treated or otherwise (EPA 1984b). The NMP encouraged a collaborative effort between EPA and states in addressing compliance with the Clean Water Act at POTWs. The NMP focused EPA's compliance efforts on three types of POTWs: those that had received federal funding and were out of compliance, and all major POTWs, and minor POTWs that discharged to impaired waters. The NMP recommended that each EPA region draft a strategy to bring POTWs into compliance with the Clean Water Act. The NMP was intended to facilitate compliance at all POTWs by July 1, 1988. While the main focus of the NMP was to ensure that POTWs complied with secondary treatment and water-quality based NPDES requirements, many enforcement actions brought under the NMP also addressed improvements to sewer systems.

7.4.2 Enforcement Management System

EPA's national enforcement guidance, *Enforcement Management System*, recommends using a scaled response to noncompliance considering such factors as the nature, frequency, and severity of the violation; potential harm to the environment and public health; and the compliance history of the facility. *Chapter X: Setting Priorities for Addressing Discharges From Separate Sanitary Sewers* includes a list of priorities for dealing with SSOs to ensure that enforcement resources are used in ways that result in maximum environmental and public health benefit (EPA 1996c). The complete text of *Chapter X* is provided in Appendix A. EPA's enforcement response guidelines range from informal actions such as telephone calls or warning letters to formal administrative or civil judicial actions.

7.4.3 Compliance and Enforcement Strategy (2000)

On April 27, 2000, EPA issued the *Compliance and Enforcement Strategy Addressing Combined Sewer Overflows and Sanitary Sewer Overflows* (EPA 2000b). This strategy was designed to ensure that CSO and SSO violations are properly addressed by promoting the enforcement and compliance assistance components of the following:

- CSO Control Policy (EPA 1994a);
- Joint Office of Enforcement and Compliance Assistance/ Office of Water memorandum “Enforcement Efforts Addressing Sanitary Sewer Overflows” (March 7, 1995); and
- Chapter X of the *Enforcement Management System* (EPA 1996c).

The strategy also supports the *Memorandum of Agreement* for EPA’s regional office performance expectations, EPA’s Clean Water Action Plan, and EPA’s Strategic Plan.

The strategy calls for each EPA region to develop compliance and enforcement plans addressing CSOs and SSOs. The plans should include:

- A systematic approach to address wet weather violations through compliance assistance;
- The identification of compliance and enforcement targets; and
- Details on NPDES state participation, including tracking of state CSO and SSO compliance and enforcement activities.

Specifically, the SSO response plan should describe the process and criteria that the region and states use to identify priority systems each year and include an inventory of SSO violations (EPA 2001a). As of August 2003, all regions except Region 4 had developed and begun implementation of their strategies.

7.4.4 Compliance Assistance

EPA has developed a number of tools for tracking and sharing compliance assistance and other information for

addressing CSOs and SSOs internally among EPA staff and externally with states, local governments, and others. Several of these tools have specific references and guidance for implementing the NMC; developing an LTCP; and implementing capacity, management, operations, and maintenance (CMOM) and asset management approaches to eliminate or reduce SSOs. Examples include:

Local Government Environmental Assistance Network (LGEAN) – The EPA-sponsored compliance assistance center for local municipal governments provides environmental management, planning, and wet weather regulatory and legislative information for elected and appointed officials, managers, and staff (<http://www.lgean.org>).

National Environmental Compliance Assistance Clearinghouse – This clearinghouse provides compliance assistance tools, contacts, and other wet weather (including CSO-specific) resources available from EPA as well as other public and private compliance assistance providers (<http://www.epa.gov/clearinghouse>).

Statistically Valid Non-Compliance Study – EPA’s Office of Enforcement and Compliance Assistance (OECA) completed the *Statistically Valid Non-Compliance Study* to assess compliance with NMC requirements. EPA has a goal of ensuring that all CSO communities have an enforceable mechanism requiring implementation of the NMC, are in compliance with those controls, and, if needed, have developed and are implementing an LTCP. Determination of the current compliance rate of CSO communities with the NMC was an EPA priority in

FY 2002. OECA found the national compliance rate with the NMC was 39 percent. OECA plans to repeat the assessment of NMC compliance in FY 2004. The new analysis will also assess the status of CSO communities with respect to development and implementation of LTCPs.

Permit Compliance System – EPA is working to modernize PCS. When complete, this database of NPDES point source dischargers will track information specifically related to CSOs and SSOs.

CSO Implementation Guidance – EPA has released eight guidance documents to assist in implementation of the CSO Control Policy. The eight guidance documents explain technical, financial, and permitting issues related to implementation of the policy and are as follows:

- *Combined Sewer Overflows Guidance for Funding Options* (EPA 1995a)
- *Combined Sewer Overflows Guidance for Long-Term Control Plans* (EPA 1995b)
- *Combined Sewer Overflows Guidance for Nine Minimum Control Measures* (EPA 1995c)
- *Combined Sewer Overflows Guidance for Permit Writers* (EPA 1995d)
- *Combined Sewer Overflows Screening and Ranking Guidance* (EPA 1995e)
- *Combined Sewer Overflows Guidance for Financial Capability Assessment and Schedule Development* (EPA 1997c)

- *Combined Sewer Overflows Guidance for Monitoring and Modeling* (EPA 1999e)
- *Guidance: Coordinating Combined Sewer Overflow (CSO) Long-Term Planning with Water Quality Standards Reviews* (EPA 2001b)

7.4.5 Summary of Enforcement Activities

Federal and state enforcement actions concluded against municipalities for CSO- and SSO-related violations are summarized below. Individual enforcement actions are listed in Appendix K.

Summary of Federal Judicial Actions

Thirty-six federal judicial enforcement actions have been concluded against municipalities in Regions 1-5 as a result of CSO violations. The relevant state served as a co-plaintiff with the EPA region in most cases. Since 1995, 26 judicial actions have been brought against municipalities in Regions 1-6 and Region 9 for SSO violations. As in the CSO judicial actions, many of the SSO actions were initiated by the EPA region in cooperation with the state.

Summary of Federal Administrative Actions

Sixty Federal AOs have been issued for CSO violations in Regions 1, 3, and 5 since 1987. Two CSO Administrative Penalty Orders (APOs) were issued to municipalities in Massachusetts. Between 1994 and 2003, 78 AOs were issued to municipalities in Regions 1-7 and Region 10 for SSO violations. Twelve SSO APOs were issued during the same period.

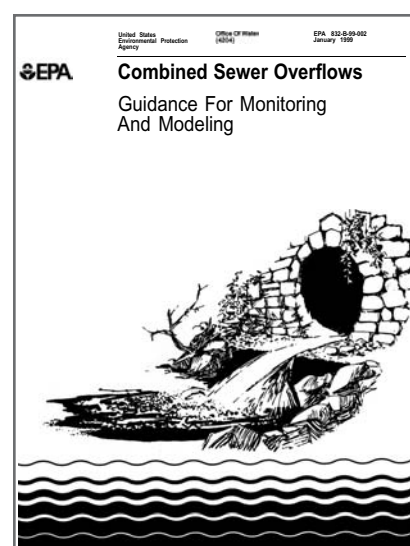

Summary of State Judicial Actions

EPA's review of available state-initiated CSO enforcement cases yielded 16 CSO civil judicial actions. EPA's review of available state-initiated enforcement cases found six judicial actions against municipalities for SSO violations.

Summary of State Administrative Actions

A number of states have initiated administrative enforcement actions to address CSO violations. A list of 53

state-initiated administrative actions for CSO violations is included in Appendix K. EPA's review of available state-initiated enforcement cases found 597 administrative actions against municipalities for SSO violations. In addition, EPA identified 18 CSO administrative penalty orders and 137 SSO administrative penalty orders issued by states.

Chapter 8

Technologies Used to Reduce the Impacts of CSOs and SSOs

Since the enactment of the Clean Water Act in 1972, federal, state, and local governments have made substantial investments in the construction, operation, and maintenance of wastewater collection and treatment systems. Municipalities employ a wide variety of technologies and operating practices to maintain existing infrastructure, minimize the introduction of unnecessary waste and flow into the sewer system, increase capture and treatment of wet weather flows reaching the sewer system, and minimize the impact of any subsequent discharges on the environment and human health. For the purposes of this Report to Congress, technologies used to control CSOs and SSOs are grouped into five broad categories:

- Operation and maintenance practices
- Collection system controls
- Storage facilities
- Treatment technologies
- Low-impact development techniques

Most technologies and operating practices are designed to reduce, not eliminate, the discharge of pollutants and attendant impacts because it is generally not feasible to eliminate all discharges.

This chapter provides an overview of technologies used to control CSOs and SSOs. In addition, the chapter also discusses:

- Factors that can influence the effectiveness of specific technology applications;
- Combinations of technologies that have proven more effective than application of individual technologies; and
- Emerging technologies that show promise in controlling CSOs and SSOs.

A complete set of detailed technology descriptions is contained in Appendix L of this report.

In this chapter:

- 8.1 What Technologies are Commonly Used to Control CSOs and SSOs?
- 8.2 How Do CSO and SSO Controls Differ?
- 8.3 What Technology Combinations are Effective?
- 8.4 What New Technologies for CSO and SSO Control are Emerging?

8.1 What Technologies are Commonly Used to Control CSOs and SSOs?

Municipalities have used numerous technologies and operational practices to reduce the volume, frequency, and impacts of CSO and SSO events. The performance and cost-effectiveness of these technologies is often related to a number of site-specific factors. Technologies deemed highly effective in one location may prove inappropriate in another. Specific factors that may influence the selection of a given technology include:

- Current condition of the sewer system;
- Characteristics of wet weather flows (e.g., peak flow rate, flow volume, concentration of key pollutants, frequency and duration of wet weather events);
- Hydraulic and pollutant loading to a particular facility;
- Climate, including seasonal variations in temperature and rainfall patterns;
- Implementation requirements (e.g., land or space constraints, surrounding neighborhood, noise, disruption, etc.); and
- Maintenance requirements.

This section describes 23 of the technologies and operational practices most commonly used to control CSOs and SSOs, including considerations for determining the applicability of different controls for individual locations. More detailed information on each technology, including cost

and performance considerations, is presented in the technology descriptions provided in Appendix L of this report.

8.1.1 Operation and Maintenance Practices

Over time, CSSs and SSSs can deteriorate structurally or become clogged by FOG and other obstructions introduced into the sewer system. Left uncorrected, these conditions can result in dry weather CSOs and SSOs. Further, these conditions often are exacerbated during wet weather when the capacity of sewer systems and treatment facilities can be severely taxed.

The objective of O&M practices is to ensure the efficient and effective collection and treatment of wastewater and to minimize the volume and frequency of CSO and SSO discharges. For purposes of this report, O&M practices include activities designed to ensure that sewer systems function as designed and strategies that rely on public education and participation. The specific O&M practices considered for this report are summarized in Table 8.1 and include:

- Inspecting and testing of the sewer system to track condition and identify potential problems;
- Cleaning or flushing deposits of sludge, sediment, debris, and FOG from the sewer system;
- Working with customers to reduce pollutant loads delivered to the sewer system; and

- Establishing procedures for notifying the public in the event of a CSO or SSO.

Sewer Inspection and Testing

Sewer inspection is used to determine the condition of sewer lines and identify potential problems. Common sewer system inspection techniques can be grouped into two categories: manual and remote. Manual inspection techniques, such as visual inspection and lamping, are simple and typically limited to the first few feet of pipe upstream and downstream of each accessible manhole. Remote inspection techniques, such as closed-circuit television and sonar, use units that are either self-propelled or pulled through the sewer line to capture information on sewer condition.

In general, sewer testing techniques are used to identify leaks that allow unwanted infiltration into the sewer system and to determine the location of direct connections of storm water sources to the sewer system (e.g., roof leaders, area drains, basement sump pumps). Sewer testing techniques fall into three categories:

- Air testing
- Hydrostatic testing
- Smoke testing

Air testing and hydrostatic testing identify cracks and other defects in the sewer system that might allow storm water or groundwater to infiltrate. Smoke testing is used to identify connections that allow direct storm water inflow to the sewer system.

Sewer Cleaning

Sewer cleaning and flushing techniques remove blockages caused by solids, FOG, and root intrusion. Sewer cleaning techniques are particularly important because blockages are the leading cause of SSO events (see Section 4.7). Cleaning techniques fall into three categories:

- Hydraulic
- Mechanical
- Chemical

Hydraulic cleaning techniques employ the cleansing action of high velocity water. Cleansing velocities are achieved by allowing water pressure to build in a sewer line or by using a pump to produce water pressure. In general, hydraulic cleaning techniques tend to be simpler and more cost-effective in removing deposited solids when compared to other sewer cleaning techniques (CSU 2001). Alternatively, mechanical cleaning methods rely on a scraping, cutting, pulling, or pushing action to remove obstructions from sewer lines. Mechanical techniques

Table 8.1

Summary of Operation and Maintenance Practices

The objective of O&M practices is to ensure that sewer systems function as designed and convey the maximum amount of flow practicable to a treatment facility.

Technology	Type of System	Pollutants/Problems Addressed
Sewer inspection and testing	CSS, SSS	I/I
Sewer cleaning	CSS, SSS	BOD ₅ , TSS, nutrients, toxics, pathogens, floatables, FOG
Pollution prevention	CSS, SSS	Nutrients, toxics, FOG
Water quality monitoring and public notification	CSS, SSS	BOD ₅ , TSS, nutrients, toxics, pathogens

are typically used in areas where the volume, size, weight, or type of debris limits the effectiveness of hydraulic techniques. Chemicals can be used to control roots, grease, odors, concrete corrosion, rodents, and insects (CSU 2001). Chemicals can be helpful aids for cleaning and maintaining sewers, though chemical applications often are localized or coupled with a hydraulic or mechanical technique.

Pollution Prevention

Pollution prevention is defined as any practice that reduces the amount of pollutants, hazardous substances, or contaminants entering the waste stream, which in turn would mean fewer pollutants in potential CSO or SSO discharges (EPA 2002b). Pollution prevention practices most often take the form of simple, individual actions that reduce the pollutants generated by a particular process. Therefore, pollution prevention programs must be implemented with broad participation to realize a discernible reduction in pollutant loads discharged to sewer systems. Public education is a key component of most pollution prevention activities. Education programs are most

successful when tailored to a specific audience (i.e., residential, institutional, or commercial).

Pollution prevention activities usually focus on best management practices for both commercial/industrial facilities and residential customers to reduce pollutant loads discharged to sewer systems. Pollutants of concern include FOG, household hazardous wastes, fertilizers, pesticides, and herbicides. In particular, the effective management of FOG has recently received attention as an important technique for controlling SSOs.

As reported in Chapter 4, FOG is the leading cause of blockages in the United States, and blockages account for nearly half of all SSO discharges. The best way to prevent blockages due to FOG is to keep FOG out of the sewer system. Many municipalities have adopted regulations controlling the introduction of FOG into the sewer system. Education programs are important in making residents and owners of institutional and commercial establishments, especially restaurants, aware of their role in managing FOG. Grease trap design and maintenance is a vital part of any

Sewer Cleaning: Sioux Falls, SD



The SSS for the City of Sioux Falls, South Dakota, consists of 578 miles of pipes ranging in size from six to 66 inches in diameter. The sewer system is divided into 20 drainage basins, and the maintenance program provides that the entire system is cleaned once every three years. Maintenance records are stored in a database that generates work orders by date and drainage basin. Sanitary sewer maintenance includes high pressure jetting, vacuuming to remove loosened debris, and mechanical and chemical root control. Closed circuit television (CCTV) is used to identify trouble spots. This results in more frequent cleaning than the scheduled three-year interval requires in problem areas. In 2001, 372 miles of sewer (64 percent of the sewer system) were televised and cleaned. The cost for these activities was approximately \$236 per inch-diameter mile of pipe. Assuming an average pipe diameter of ten inches, inspection and cleaning costs about \$0.45 per linear foot.

education program for commercial and institutional customers.

Water Quality Monitoring and Public Notification

Water quality monitoring and public notification practices are important in minimizing potential human health impacts that can result from exposure to pathogens and other pollutants in CSO and SSO discharges. Water quality monitoring is used routinely to verify the suitability of a particular waterbody for fishing, swimming, or as a drinking water source; and to identify whether a specific CSO or SSO event has impaired water quality. Public notification programs are intended to communicate water quality monitoring results, general information regarding the occurrence of CSO and SSO events, and municipal efforts to control discharges. Public notification program activities include posting temporary or permanent signs where CSOs and SSOs occur, coordinating with civic and environmental organizations, and distributing fact sheets to the public and the media. Monitoring and public notification programs should be a high priority at beaches or recreational areas, whether directly or indirectly affected by CSOs and SSOs, due to the increased risk of human contact with pollutants and pathogens (EPA 2002i).

When developing a monitoring and public notification program, the lag time that often occurs between collecting water samples and providing the public with results is important to consider. This lag is due to the time required (from 24 to 72 hours) to test for the presence of bacterial indicators of contamination. During this time, pathogen levels, weather,

and water conditions, and related environmental or human health risks may change. This means that decisions regarding beach and recreational water postings, closings, and re-openings using bacterial indicators often reflect conditions as they were one to three days earlier (EPA 2002i). Further, contaminants may no longer be present once test results are available, and safe beaches may be closed needlessly. As described in Chapter 6, some communities and beaches have procedures to close beaches proactively when a CSO-producing rainfall event has occurred.

8.1.2 Collection System Controls

Collection system controls are designed to maximize the capacity of the sewer system to transport or store domestic, commercial, and industrial wastewater. This is accomplished by adjusting hydraulic control points to maximize available sewer system capacity and by implementing programs and practices to minimize the volume of I/I that enters the sewer system. The specific collection system controls considered for this report are summarized in Table 8.2, and include:

- Maximizing flow to the treatment plant;
- Installing a network of flow monitors to better understand and manage the response of the sewer system to wet weather events;
- Identifying and eliminating direct connections of storm water to the sewer system (inflow);
- Separating combined sewer systems into storm and sanitary systems; and



This CSO notification sign is posted along Brandywine Creek in Wilmington, Delaware, as part of a public notification program. It warns swimmers of the presence of a CSO outfall and advises that raw sewage and bacteria may be present after a storm.

Photo: City of Wilmington Department of Public Works

- Rehabilitating sewer system components.

Collection system controls are designed to maintain the structural integrity of CSSs and SSSs, and to maximize available capacity for transporting wastewater to a treatment plant. Some municipalities have found combining various rehabilitation techniques with inflow reduction activities to be a cost-effective and successful means of controlling SSOs. Other municipalities have found that implementing one or more of these collection system controls in conjunction with storage facilities or treatment a cost-effective CSO control.

Maximizing Flow

EPA encourages plants serving CSSs and SSSs to minimize CSOs and SSOs during wet weather events by using existing infrastructure to maximize flow to the treatment plant (EPA 1994a; NYSDEC 1997). Maximizing flow to the treatment plant often involves simple and low-cost measures, including:

- Capacity evaluations of the sewer system and pumping stations to

determine the maximum amount of flow that can be transported (Sherrill et al. 1997).

- Sewer investigations to identify bottlenecks or constrictions that limit flow in specific areas and prevent downstream treatment capacity from being fully utilized.
- Targeted O&M activities to address structural deterioration, obstructions due to FOG and sediment buildup and excessive I/I.

The benefits of maximizing wet weather flows to the existing treatment plant depend on the ability of the plant to accept and provide treatment to increased flows. The consequences of mismanaging extreme flows at the treatment plant include flooding the treatment plant and washing out biological treatment processes, which can result in reduced treatment capacity and efficiency at the plant for extended periods of time. Likewise, changes in sewer system operation without a careful analysis of transport capacity can result in increased building backups or street flooding.

Table 8.2

Summary of Collection System Controls

Collection system controls are designed to maximize the use of existing sewers to collect and convey wastewater to a treatment facility.

Technology	Type of System	Pollutants/Problems Controlled
Maximizing flow to the treatment plant	CSS, SSS	BOD ₅ , TSS, nutrients, toxics, pathogens, floatables
Monitoring and real-time control	CSS, SSS	Peak wet weather flow rate
Inflow reduction	CSS, SSS	I/I, peak wet weather flow rate
Sewer separation	CSS	I/I, peak wet weather flow rate
Sewer rehabilitation	CSS, SSS	I/I, peak wet weather flow rate
Service lateral rehabilitation	CSS, SSS	I/I, peak wet weather flow rate
Manhole rehabilitation	SSS	I/I, peak wet weather flow rate

Monitoring and Real-Time Control

Basic flow monitoring is an important component of O&M programs in most systems. Effective monitoring programs enable evaluations of diurnal and day-to-day flow patterns as well as I/I in a sewer system. Moreover, monitoring is extremely valuable in establishing maintenance schedules, developing hydraulic models, planning related to capital improvements, and ensuring regulatory compliance.

Enhanced monitoring programs in SSSs and real-time control systems in CSSs use more complex flow monitoring networks to optimize sewer system performance. In SSSs, enhanced monitoring information can be used to identify blockages or capacity-constrained areas of the sewer system where wet weather SSOs are likely to occur. In CSSs, integration of real-time flow, regulator, pump, and storage information can be used to maximize use of storage capabilities and to maximize flow to the treatment plant.

Inflow Reduction

Inflow is the entry of extraneous storm water into a sewer system from sources other than infiltration, such as basement drains, roof leaders, manholes, and storm drains. Inflow reduction refers to the identification and elimination of these sources to reduce the amount of storm water that enters CSSs and SSSs. By reducing the volume of storm water entering the sewer system, more conveyance, storage, and treatment capacity is available for sanitary flows during wet weather. This, in turn, aids in reducing the frequency, volume, and

duration of wet weather CSO and SSO events. Common inflow reduction techniques include the disconnection of roof leaders, redirection of area and foundation drains and basement sump pumps, and elimination of cross-connections between separate sanitary and storm water systems (EPA 1999f).

Inflow reduction techniques can be an efficient way to improve sewer system performance, especially when the diverted storm water can be conveniently directed either to surface waters or to open land for infiltration or detention (EPA 1999f). For SSSs, inflow reduction techniques usually target specific areas with chronic SSOs. For CSSs, these techniques are applied more broadly to minimize the size of structural controls.

Sewer Separation

Sewer separation is the practice of separating the single-pipe CSS into separate systems for sanitary and storm water flows. Full separation can be applied on a system-wide basis to eliminate the CSS. This approach is most practical for communities with small areas served by combined sewers. Separation of select areas within a CSS is widely used by large and small CSO communities as an element of a broader LTCP.

Sewer separation can be highly effective in controlling the discharge of untreated wastewater. Under ideal circumstances, full separation can eliminate CSO discharges. A survey of readily available information in NPDES files indicates that sewer separation is the most widely used CSO control, accounting for half of CSO control measures found in LTCP



The Milwaukee Metropolitan Sewer District uses real-time data to monitor the flow in its sewer system tunnels and pipes.

Photo: Milwaukee Metropolitan Sewer District

Monitoring and Real-Time Control: Seattle, WA

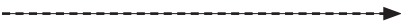

Seattle was one of the first U.S. communities to implement and operate an advanced real-time control system to control CSO discharges. Seattle's system, called Computer Augmented Treatment and Disposal (CATAD), began operating in 1971. In the late 1980s, treatment plant computer hardware was upgraded, remote telemetry units at regulators and pump stations were replaced by programmable logic controllers, and graphical displays used by operators were improved. Based on the success of the CATAD technology, Seattle implemented a new, predictive real-time control system that went on-line in early 1992. Rainfall prediction capabilities that utilize rain gage data and a runoff model were added. A global optimization program was introduced that computed optimal flow and corresponding gate position for each regulator within the CSS. A distributed network allows control decisions to be implemented without operator intervention. The computer program uses real-time operation and system performance data to predict or forecast conditions through the system and directs control elements to utilize in-line storage during periods of high flow.



The direct connection of roof leaders (shown above) and other inflow sources can limit sewer system capacity for conveying sanitary wastewater during wet weather.

Photo: Milwaukee Metropolitan Sewer District

documentation (EPA 2001a). This suggests that many CSO communities identify portions of their CSS in which separation is a cost-effective CSO control. Under these circumstances, separation is often implemented in conjunction with other public works projects, including road work and redevelopment. Sewer separation on its own, however, does not always lead to an overall reduction in pollution or the attainment of water quality standards. Storm water discharges from the newly created separate storm sewer system can contain substantial pollutant loads that may cause or contribute to water quality problems. Implementation of storm water controls may be necessary following sewer separation in order to achieve the pollutant load reductions necessary for attainment of water quality standards.

In practice, there are three distinct approaches to sewer separation:

- Full separation wherein new sanitary sewer lines are constructed with the existing CSS becoming a storm sewer system.

This is probably the most widely used form of separation.

- Full separation wherein an entirely new storm sewer system is constructed with the existing CSS remaining as a sanitary sewer system. This form of separation is not often used because the capacity of the existing CSS was designed to accommodate storm water runoff, which is more than what is required to accommodate sanitary flows.
- Partial separation wherein a new storm sewer system is constructed for street drainage, but roof leaders and basement sump pumps remain connected to the existing CSS.

Sewer Rehabilitation/Replacement

The structural integrity of many sewer system components deteriorates with use and age. This gradual breakdown allows more groundwater and storm water to infiltrate into the sewer system. This increases the hydraulic load and, in turn, reduces the system's ability to convey all flows to the treatment plant. During wet weather

events, excessive infiltration can cause or contribute to CSOs and SSOs. Sewer rehabilitation/replacement restores and maintains the structural integrity of the sewer system, in part by reducing or mitigating the effects of infiltration. Common sewer rehabilitation and replacement techniques include:

- Removal and replacement of defective lines;
- Trenchless technologies that use the existing sewer to support a new pipe or line;
- Shotcrete, wherein a mixture of cement, sand, and water is applied to sewer walls; and
- Grouting and epoxy injections to seal leaks and cracks.

Inspecting and evaluating current sewer condition is necessary before a sewer rehabilitation technique is chosen, as the condition of the sewer may favor specific techniques. Removing and replacing defective lines is the most commonly used rehabilitation technique when the sewer line is structurally deficient (CSU 2001). Complete replacement is often the most effective rehabilitation method in areas where increased conveyance capacity is needed (WEF 1999a).

Trenchless technologies are especially well-suited to urban areas where the traffic disruption associated with large-scale excavation projects can be a significant obstacle to a project (WEF 1999a). In addition, many sewers are located near other underground utilities in urban areas, which can complicate traditional dig-and-replace

methods; trenchless technologies avoid underground utilities by using the existing sewer to support a new pipe or line. Trenchless technologies include sliplining, cured-in-place pipe (CIPP), modified cross-section liners, and pipe bursting.

Shotcrete, a non-invasive rehabilitation method, is often used to rehabilitate sewers with major structural problems. Shotcrete, however, can be used only in pipe with a diameter of at least 36 inches (CSU 2001).

Grouting and epoxy injections are most appropriate when the sewer is structurally stable but experiencing infiltration.

Service Lateral Rehabilitation

Private building service laterals are the pipes that convey wastewater from individual buildings, including houses, to the municipal sewer system. Recent studies indicate that a significant component of the infiltration in any sewer system is the result of service lateral defects that contribute varying quantities of I/I (WEF 1999b). During wet weather events, excessive I/I can cause or contribute to CSOs and SSOs. In general, service lateral rehabilitation techniques are similar to those used for larger diameter sewers and include:

- Removing and replacing defective service laterals;
- Applying trenchless technologies that use the existing service lateral to support a new pipe or liner; and
- Using grouting and epoxy injections to seal leaks and cracks.

Assigning responsibility for the repair or replacement of service laterals is often cited as the biggest obstacle to correcting known defects. Notably, several studies highlighted significant problems in gaining access to private property until the municipality assumed full financial responsibility for the repair or replacement costs (Paulson et al. 1984; Curtis and Krustsch 1995).

Manhole Rehabilitation

Manholes must be maintained and kept in working condition. Structurally defective manholes can be a significant source of I/I that otherwise would not enter an SSS. Damage to manhole covers and rims often occurs during road work, and it can allow storm water runoff from roads and sidewalks to flow directly into the sewer system. Further, cracks and openings in the sidewalls and base

of the manhole can allow groundwater and storm water to infiltrate into the sewer system. Manhole rehabilitation can reduce I/I, restore the structural integrity of the manhole, and preserve SSS capacity for transporting wastewater. Common manhole rehabilitation methods include (ASCE 1997):

- Sealing pick holes in the manhole cover and installing gaskets between the manhole cover and frame to eliminate storm water inflow;
- Implementing spot repairs with chemical grout or fast-drying cement to patch defects in manhole sidewalls or bases;
- Coating systems to rebuild structural integrity and protect concrete, steel, and masonry manhole structures against deterioration;

Service Lateral Rehabilitation: Montgomery, AL



In Alabama, the Montgomery Water Works and Sanitary Sewer Board (MWWSSB) evaluated nearly 2.2 million linear feet of its sewer system, identifying 3,394 defects. Eighty-five percent of these defects were in service laterals; 97 percent of lateral defects identified have been repaired.

Lateral repairs necessary within the city street right-of-way are made by MWWSSB with consent and release of liability from the property owner. MWWSSB replaces missing clean-out covers for a minimal cost with written permission from the property owner. The property owners are responsible for the cost of all lateral repair and replacement on their property.

Property owners initially received a 60-day notice of lateral repair requirements. Another 10-day notice was sent if the property failed to respond to the initial notice. Finally, if the property owner failed to respond to either notice, water service to the property was shut off. Sixty-five percent of property owners responded after receiving the initial notice. The remaining property owners corrected their defects under threat of having their water service discontinued.

In selected areas where service lateral rehabilitation has been completed, the I/I was reduced by an average of 42 percent. It is estimated that the annual I/I volume in the MWWSSB service area has been reduced by 36 million gallons. The cost of establishing the I/I program was approximately \$150,000. MWWSSB spends \$207,000 annually to operate the program.

- Reconstructing manholes in cases of substantial structural degradation; and
- Placing inserts and liners in deteriorated manholes.

Inspection of the manhole components is a necessary first step in selecting an appropriate rehabilitation technique. Spot repairs of manhole components are most appropriate for addressing minor defects, and chemical grouts are commonly used for rehabilitating structurally sound manholes made of brick. Coating systems are applicable for manholes with brick structures that show little or no evidence of movement or subsidence and at sites not conducive to excavation or major reconstruction. Structural linings are applicable for standard manhole dimensions (48- to 72-inch inner diameter) where substantial structural degradation has occurred. Structural linings tend to be more expensive than other rehabilitation techniques.

8.1.3 Storage Facilities

Many sewer systems experience increased flow during wet weather. In systems that are unable to transport or provide full treatment for wet weather flows, storage facilities are often used to reduce the volume, frequency, and duration of CSO and SSO events. Storage facilities fill during wet weather and are drained or pumped to

the wastewater treatment plant once conveyance and treatment capacity have been restored following the wet weather event. Specific types of storage facilities considered for this report are summarized in Table 8.3.

Storage facilities have seen wide application as a CSO control because of the large and frequent volumes of combined sewage requiring control; however, a number of communities have also found storage facilities, especially flow equalization basins, to be an effective wet weather SSO control.

In-line Storage

In-line or in-system storage is the term used to describe storage of wet weather flows within the sewer system. Taking advantage of storage within the sewer system has broad application and can often reduce the frequency and volume of CSOs and SSOs without large capital investments. Maximization of storage in the sewer system is also one of the NMC required of all CSO communities. The amount of storage potentially available in the sewer system largely depends on the size or capacity of the pipes that will be used for storage and on the suitability of sites for installing regulating devices.



Damaged manholes, such as the broken cover shown above, can be a significant source of storm water I/I into an SSS.

Photo: Limno-Tech, Inc.

Technology	Type of System	Pollutants/Problems Addressed
In-line storage	CSS, SSS	Peak wet weather flow rate, BOD ₅ , TSS, nutrients, toxics, pathogens, floatables
Off-line storage	CSS, SSS	Peak wet weather flow rate, BOD ₅ , TSS, nutrients, toxics, pathogens, floatables
On-site storage and flow equalization basins	CSS, SSS	Peak wet weather flow rate, BOD ₅ , TSS, nutrients, toxics, pathogens, floatables

Table 8.3

Summary of Storage Facilities

Storage facilities have seen wide application in attenuating peak wet weather flows in both CSS and SSS.

In-line storage techniques include the use of flow regulators, in-line tanks or basins, and parallel relief sewers. Flow regulators optimize in-line storage by damming or limiting flow in specific areas of the sewer system. Storage tanks and basins constructed in-line are typically governed by flow regulators. Dry weather flows pass directly through in-line storage tanks or basins, and flow regulators limit flow exiting the facility during wet weather periods. In-line capacity can also be created by installing relief sewers parallel to existing sewers or by replacing older sewers with larger diameter pipes. Again, flow regulators are used to optimize storage within these facilities.

Areas where the sewer slope is relatively flat typically offer the best opportunities for in-line storage. One factor that limits the applicability of in-line storage is the possibility that this approach can increase basement backups and street flooding (EPA 1999g). Use of in-line storage may also slow flow, allowing sediment and other debris to settle in the sewer. If allowed to accumulate, sediment and debris can reduce available storage and conveyance capacity. Therefore, an important design consideration for in-line storage is to ensure that minimum flow velocities are provided to flush and transport solids to the wastewater treatment plant.

Off-line Storage

Off-line storage is the term used to describe facilities that store wet weather flows in near-surface storage facilities, such as tanks and basins or deep tunnels located adjacent to the sewer system. Off-line storage facilities

have broad applicability and can be adapted to many different site-specific conditions by changing the basin size (volume), layout, proximity to the ground surface, inlet or outlet type, and disinfection mechanism. For these reasons, off-line storage facilities are one of the most commonly implemented CSO controls (EPA 2001a). The use of off-line storage tends to be more expensive than in-line storage; it is usually considered in areas where in-line storage is insufficient or unavailable.

A typical near-surface storage facility is a closed concrete structure built at or near grade alongside a major interceptor. Deep tunnel storage facilities are used where large storage volumes are required and opportunities for near-surface storage are unavailable. As their name implies, deep tunnels are typically located 100 to 400 feet below ground. Tunnel diameters range from 10 to 50 feet, and many are several miles in length.

During dry weather, untreated wastewater is routed around, not through, off-line storage facilities. In contrast, during wet weather, flows are diverted from the sewer system to the off-line storage facilities by gravity drainage or with pumps. The wastewater is detained in the storage facility and returned to the sewer system once downstream conveyance and treatment capacity become available. Overflows can occur if the capacity of off-line storage structures is exceeded. Some treatment is provided through settling; however, the primary function of such facilities is storage and the attenuation of peak wet weather flows.

As part of Philadelphia's effort to control CSOs, the City Water Department plans to install three inflatable dams in large diameter sewers that have available in-line storage. The dams will range from 11 to 15 feet high and will be automatically controlled for both dry and wet weather conditions. The three dams will enable 16.3 MG of flow that might otherwise discharge to local receiving waters to be stored in existing sewers per storm event, reducing CSO volumes by 650 MG per year.

The first inflatable dam, located in the city's main relief sewer, will be operational by the end of 2004. The associated civil work projects including sewer rehabilitation have been completed for this project. When operational, the dam will have the ability to store up to 4 MG of combined sewage, and it is expected to reduce the number of CSO discharges to the Schuylkill River from 32 per year to four per year. Another inflatable dam will be installed in Rock Run during the summer of 2005. The total cost for the installation of the dams and sewer rehabilitation is approximately \$4.8 million, or \$0.29 per gallon of storage.

In-line Storage: Philadelphia, PA

On-site Storage

On-site storage, which is storage developed at the wastewater treatment facility, is often an effective control for managing wet weather flows in systems where sewer system conveyance capacity exceeds that of the treatment plant. On-site storage can play an important role in improving treatment plant operations by providing operators with the ability to manage and store excess flows. The costs associated with the development of on-site storage are, on average, considerably lower than the construction costs for typical near surface off-line storage facilities built outside the bounds of the treatment plant. Much of the cost savings derive from siting storage facilities on land already owned by the utility. It should be noted, however, that sewer system conveyance capacity may limit the amount of wet weather flow that can be brought to an on-site storage facility, and expanding conveyance capacity can be extremely expensive.

The two most common forms of on-site storage are flow equalization basins

(FEBs) and converted abandoned treatment facilities. FEBs are used to attenuate peak wet weather flows and to improve wet weather treatment plant operations (Metcalf and Eddy 2003). Abandoned treatment facilities can function in a manner similar to FEBs in attenuating peak wet weather flows. Abandoned facilities that have been successfully converted for storage include old clarifiers, treatment or polishing lagoons, and abandoned pretreatment facilities at industrial sites near the treatment plant.

8.1.4 Treatment Technologies

In many systems, wet weather flows can exceed the existing conveyance and treatment capacity. The development of wet weather treatment systems presents a viable alternative to storing excess flows. Treatment technologies are end-of-pipe controls, used to provide physical, biological, or chemical treatment to excess wet weather flows immediately prior to discharge from a CSS or SSS. Specific treatment technologies can address different pollutants, such as settleable solids, floatables, and pathogens.

**On-site Storage:
Oakland, ME**



The sewer system in Oakland, Maine, consists mainly of combined sewers. The city has been implementing CSO controls since 1997. These efforts include separating a portion of the CSS and targeted inflow reduction activities. As a result, Oakland has been able to eliminate both of its CSO outfalls and transport all wet weather flows to its wastewater treatment plant. Although the city had sufficient sewer system capacity to transport these wet weather flows, it did not have facilities capable of treating the peak wet weather flow. The city was able to use an FEB installed at a nearby textile mill that is no longer operating. The FEB was built in 1990 by the textile mill as part of their pretreatment program and had not been used since the plant closed. Oakland is able to store 0.2 MG of excess wet weather flows in the FEB, and release it back to the wastewater plant for treatment as capacity becomes available. The FEB is mainly used to control excess wet weather flow during spring snowmelts. Bringing the FEB back into operation cost approximately \$27,610, or \$0.14 per gallon of storage.

For the purposes of this Report to Congress, treatment technologies are assumed to operate intermittently, with dry weather flows from the CSS or SSS handled by the existing wastewater treatment plant. Treatment technologies considered here include strategies for developing wet weather treatment capacity at remote locations in the sewer system and for enhancing the performance of the existing treatment facility when flows exceed the rated capacity of the plant. Specific technologies and operational practices are summarized in Table 8.4 and include:

- Constructing supplemental treatment facilities for treating excess wet weather flows;
- Modifying the POTW to better accommodate high flows;
- Disinfecting excess wet weather flows;
- Using vortex separators to provide partial treatment for excess wet weather flows; and
- Constructing facilities to remove floatables from CSO discharges.

In general, treatment technologies have not been as widely applied as other CSO and SSO controls, partly due to cost and the difficulty of remote control. Also, the requirements for permitting treated discharges from off-site SSO facilities during wet weather are somewhat unclear.

Supplemental Treatment

As the name implies, supplemental treatment technologies are intended to supplement existing wastewater treatment capacity during periods of wet weather. Example applications include installing a small scale treatment facility in a capacity-constrained area of the sewer system, or adding a parallel treatment process at the existing treatment plant to be operated only during wet weather. Selection of a supplemental treatment technology is determined by the level of treatment required and the characteristics of the wet weather flow. Technologies commonly considered as potential supplemental treatment processes for excess wet weather flows include:

- Ballasted flocculation or sedimentation using a fine-grained

Technology	Type of System	Pollutants/Problems Controlled
Supplemental treatment	CSS, SSS	Peak wet weather flow rate, BOD ₅ , TSS, pathogens
Plant modifications	CSS, SSS	Peak wet weather flow rate, BOD ₅ , TSS
Disinfection	CSS, SSS	Pathogens
Vortex separators	CSS	TSS, floatables
Floatables controls	CSS	Floatables

Table 8.4

Summary of Treatment Technologies

Based on life-cycle cost evaluations, treatment technologies may be an effective technique for handling excess wet weather flows.

sand, or ballast, and a coagulant to accelerate settling of solids from wastewater;

- Chemical flocculation using metal salts and polymers to accelerate settling of solids from wastewater;
- Deep bed filtration with coarse sand to filter wastewater; and
- Microscreens.

Supplemental treatment technologies must have quick start-up times after extended periods of no flow (or low flow) conditions, accommodate sudden increases in flow at unplanned times, and provide adequate treatment despite significant variation in flow rates and influent pollutant concentrations.

Plant Modifications

Simple modifications to existing wastewater treatment facilities can increase their ability to handle wet weather flows. Modifications can involve changes to the physical configuration of various treatment processes and the operation of specific plant processes during wet weather. Most modifications require the active involvement of the treatment plant operator to ensure effective implementation. Example modifications that maximize the treatment of wet weather flows include:

- Ensuring the even distribution of flow among treatment units;

Supplemental Treatment: Tacoma, WA

The Central Treatment Plant (CTP) for the City of Tacoma, Washington, receives flow from an SSS serving a population of 208,000. The CTP has a peak biological treatment capacity of 78 mgd. The sewer system, however, can deliver up to 110 mgd to the CTP. Tacoma plans to install a ballasted flocculation process at the CTP, in parallel with the existing processes, to handle wet weather flows in excess of the peak biological treatment capacity. The ballasted flocculation process will cost approximately \$12.4 million. All related peak wet weather flow facilities upgrades are estimated at \$50.7 million. In comparison, expanding the existing activated sludge processes would cost an estimated \$130 million; this estimate does not include the cost for additional primary clarification capacity. When the ballasted flocculation process is brought on-line for wet weather treatment, effluent from the process will be separately disinfected and blended with disinfected biologically treated effluent prior to discharge. The blended effluent is expected to meet permit limits. The ballasted flocculation process is expected to operate a maximum of 5.5 days in a row, 8 days in a month, and 21 days per year (Parametrix 2001).

- Installing baffles to protect clarifiers from hydraulic surges (NYSDEC 2001);
- Using metal salts and polymers to increase suspended solids removal;
- Switching the mode of delivering flow from the primary to the secondary treatment units;
- Switching from “series” operation of unit processes during dry weather flows to “parallel” operation during wet weather flows; and



Ultraviolet light is used to disinfect wet weather flows as part of the Columbus, Georgia, Water Works CSO Technology Testing Program.

Photo: Columbus Water Works

Performance evaluations are conducted to determine whether additional capacity can be obtained from existing facilities. While plant modifications are generally more cost effective than new construction, some modifications that improve wet weather performance may result in increased concentrations of pollutants in treatment plant effluent during dry weather. For example, if not properly designed, a clarifier modified for wet weather flows may have inadequate settling characteristics during dry weather (Metcalf and Eddy 2003). Further, modifications that require operator attention before and after a wet weather event may interrupt regular dry weather operations and potentially compromise the quality of treated wastewater during dry weather.

Disinfection

Disinfection of wastewater is necessary for public health protection when the public may come into contact with wastewater discharges. Wastewater treatment plants typically include a disinfection process designed specifically to inactivate bacteria,

viruses, and other pathogens in the treated wastewater. The application of disinfection to CSO and SSO discharges has been limited.

Achieving adequate disinfection of excess wet weather flows can be difficult. High flow rates can result in reduced exposure of wastewater to the disinfecting agent and possibly reduced effectiveness of the disinfection process. Among conventional disinfection processes, chlorine disinfection has been used most often to successfully disinfect wet weather flows. Effects of this method, however, include toxic residual chlorine and chlorine disinfection by-products that limit the utility of chlorination for disinfection in some areas. Experience with ultraviolet (UV) light and other alternatives has increased considerably in recent years and may be practical for wet weather flow receiving a minimum of primary treatment.

Vortex Separators

Vortex separators (swirl concentrators) are designed to concentrate and remove suspended solids and floatables from wastewater or storm water. Applications of vortex separators, for the most part, have been limited to CSSs. Vortex separators use centripetal force, inertia, and gravity to divide combined sewage into a smaller volume of concentrated sewage, solids, and floatables; and a large volume of more dilute sewage and surface runoff. Typically, the concentrated sewage and debris are conveyed to the treatment plant, and the dilute mix is discharged to a receiving water. This discharge may or may not receive disinfection.

Vortex separators provide a modest level of treatment for a modest cost. They are useful in controlling suspended solids and floatables and in reducing pollutants associated with solids such as metals bound to sediments. Vortex separators have limited ability to reduce dissolved pollutant or bacteria concentrations unless, in the latter case, disinfection is applied in conjunction with vortex separation (Brashear et al. 2002). When used in combination with other CSO controls, the placement of vortex separators is very important. Because they are designed to remove suspended solids and floatables, vortex separators should not be placed downstream of other facilities that perform the same function, such as sedimentation basins or grit chambers. (Moffa 1997).

Floatables Controls

Floatables controls are principally applied in CSSs and are designed to mitigate aesthetic impacts of CSO discharges by minimizing the amount of litter and other debris entrained in the CSO. Floatables controls are widely used to control solids and floatables in urban storm water discharges from separate storm sewer systems. Improvements in water quality from floatables controls may be secondary. The CSO Control Policy recognized the importance of controlling solid and floatable material by including it under the NMC (EPA 1994a). Floatables controls can be grouped into three categories:

- Source controls that work to prevent solids and floatables from entering the CSS.

- Collection system controls that keep solids and floatables in the sewer system, so they can be collected and removed at strategic locations or transported to the wastewater treatment plant.
- End-of-pipe controls, such as containment booms and skimmer boats, capture solids and floatables as they are discharged from the sewer system. End-of-pipe controls can create temporary unsightly conditions near CSO outfalls and may be undesirable in areas with waterfront development.

Ensuring the efficient and effective operation of all types of floatables controls requires proper maintenance. The optimal period between maintenance activities ranges from a few weeks to semi-annually, depending on the technology employed.

8.1.5 Low-Impact Development Techniques

Low-impact development (LID) techniques seek to control the timing and volume of storm water discharges from impervious surfaces (e.g., building roofs and parking lots) to the sewer system as well as the volume of wastewater generated by residential, commercial, and industrial customers. Controlling the timing and volume of storm water discharges can be an important component of a program to control CSOs. Reducing the volume of wastewater generated within the service area frees capacity within both CSSs and SSSs for transport of additional flows during wet weather. Specific LID techniques considered for this report are summarized in Table 8.5.

Table 8.5

Summary of Low-Impact Development Techniques

Low-impact development techniques are most useful in attenuating peak wet weather flow rates associated with urban and suburban storm water runoff.

Technology	Type of System	Pollutants/Problems Controlled
Porous pavement	CSS	Peak wet weather flow rate
Green roofs	CSS	Peak wet weather flow rate
Bioretention	CSS	Peak wet weather flow rate
Water conservation	CSS, SSS	Peak wet weather flow rate

While the concept of using LID to control storm water runoff is familiar, the application of LID techniques for CSO control has been limited (University of Maryland 2002). It is unlikely that LID techniques alone are sufficient to fully control CSOs, yet they have shown promise as part of larger programs in reducing the size of structural controls (e.g. storage). The use of LID as an SSS control is limited to situations in which LID might contribute to inflow control. LID has great potential as a storm water control for the separate storm sewer system that complements an SSS.

Porous Pavement

Porous pavement is an infiltration system in which storm water runoff enters the ground through a permeable layer of pavement or other stabilized permeable surface (EPA 1999h). The use of porous pavement reduces or eliminates impervious surfaces, thus reducing the volume of storm water runoff and peak discharge volume generated by a site. Reducing the amount of stormwater that enters the CSS increases conveyance and storage capacity. This in turn leads to reductions in the volume and frequency of CSOs.

Porous pavement is used as an alternative to conventional impervious pavement, under certain

conditions. The success of porous pavement applications depends on design criteria including site conditions, construction materials, and installation methods. Typically, porous pavement is most suitable for areas with sufficient soil permeability and low traffic volume. Common applications include parking lots, residential driveways, street parking lanes, recreational trails, golf cart and pedestrian paths, shoulders of airport runways, and emergency vehicle and fire access lanes. This technology is not recommended for areas that generate highly contaminated runoff such as commercial nurseries, auto salvage yards, fueling stations, marinas, outdoor loading and unloading facilities, and vehicle washing facilities, as contaminants could infiltrate into groundwater (SMRC 2002).

Green Roofs

Green roofs use rooftop vegetation and underlying soil to intercept storm water, delay runoff peaks, and reduce runoff discharge rates and volume. Their use can lead to reductions in the volume or occurrence of CSOs. Green roofs are becoming an important tool in areas with dense development where the use of other space-intensive storm water management practices, such as detention ponds and large infiltration systems, is impractical.

There are two basic types of green roofs: intensive and extensive. Intensive green roofs, also known as conventional roof gardens, are landscaped environments developed for aesthetic and recreational uses that require high levels of management. Extensive green roofs, or eco-roofs, make use of a continuous, thin layer of growing medium that sustains low-maintenance vegetation tolerant of local climatic conditions.

Intensive and extensive green roofs have been successfully installed in cities across the United States, both as part of new building design and retrofitted to existing buildings (e.g., Chicago, IL; Philadelphia, PA; Portland, OR). Green roofs can be designed for commercial buildings, multi-family homes, industrial structures, and single-family homes and garages. Factors that must be considered before installing a green roof include the load-bearing capacity of the roof deck, the moisture and root penetration resistance of the roof membrane, roof slope and shape, hydraulics, and wind shear.

Bioretention

Bioretention is a soil and plant-based storm water management practice used to filter and infiltrate runoff from impervious areas such as streets, parking lots, and rooftops. Bioretention systems are essentially plant-based filters designed to mimic the infiltrative properties of naturally vegetated areas, reducing runoff rates and volumes. Their use can lead to reductions in CSO and SSO volume and frequency. The complexity of bioretention systems depends on the volume of runoff to be controlled,

available land area, desired level of treatment, and available funding. Bioretention systems can be used as a stand-alone practice (off-line) or connected to a separate storm sewer system (on-line).

Bioretention systems can be implemented in new development or be retrofitted into developed areas. Bioretention systems are easier to incorporate in new developments, due to fewer constraints regarding siting and sizing. They can be applied in heavily urbanized areas, including commercial, residential, and industrial developments. For example, bioretention can be used as a storm water management technique in median strips, parking lots with or without curbs, traffic islands, sidewalks, and other impervious areas (EPA 1999i).

The effectiveness of bioretention systems depends on infiltration capacity and treatment capability. Systems must be sized to match expected runoff. Runoff volumes in excess of the system's capacity must be handled in such a way as to avoid erosion and destabilization of the site. Typical maintenance activities for bioretention systems include re-mulching void areas; treating, removing, and replacing dead or diseased vegetation; watering plants until they are established; inspecting and repairing soil, as needed; and removing litter and debris.

Water Conservation

Water conservation is the efficient use of water in a manner that extends water supplies, conserves energy, and reduces water and wastewater

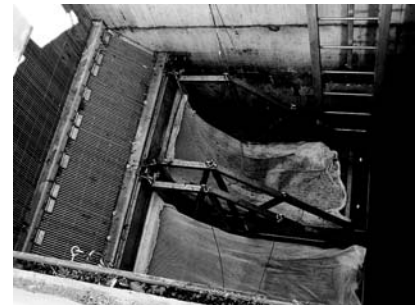

In-system netting can provide floatables control at strategic locations in the sewer system.

Photo: New Jersey Department of Environmental Protection

treatment costs. Reducing water use can decrease the total volume of domestic sewage conveyed by a sewer system, which can increase conveyance and treatment capacity during periods of wet weather and potentially reduce the volume and frequency of CSOs and SSOs. Numerous indoor and outdoor practices reduce water consumption, including (GBS 2002):

- High efficiency fixtures and appliances such as low-flow toilets, urinals, showerheads, and faucets, and water-efficient washing machines and dishwashers.
- Water recycling and reuse of wastewater from sinks, kitchens, tubs, washing machines, and dishwashers for landscaping, flushing toilets, and other non-potable purposes.
- Waterless technologies such as composting toilets and waterless urinals.
- Rain harvesting, in which roof runoff is collected, stored, and used primarily for landscaping.

In most instances, money saved from reduced water and sewer bills offsets installation costs over time. Among high efficiency fixtures and appliances, low-flow showerheads and faucet aerators are almost always cost-effective to install due to their relatively low cost and minimal labor requirements. Low-flow toilets also have widespread application, particularly in commercial and institutional settings, because the economic offset period can be relatively short. The cost effectiveness of the other water conservation

technologies mentioned depends on site-specific considerations.

8.2 How Do CSO and SSO Controls Differ?

Although many of the technologies considered in this report have proven useful in controlling overflows from both CSSs and SSSs, EPA found that applications of certain technologies were more common to a particular type of system. This section highlights technologies with particular application in either CSSs or SSSs.

8.2.1 Common CSO Control Measures

Implementation of the NMC was expected to be one of the first steps taken by CSO communities in response to the CSO Control Policy. In general, the NMC are controls that reduce CSOs and their impacts on the environment and human health, but do not require significant engineering studies or major construction, and are implemented in a relatively short period (e.g., within a few years). Most activities completed as part of implementing the NMC are considered O&M practices or collection system controls. The most common NMC activities include (EPA 2001a):

- Sewer cleaning
- Pollution prevention
- Inflow reduction

In developing and implementing a CSO LTCP, municipalities are expected to consider more significant structural



Bioretention systems can reduce the amount of storm water runoff generated by impervious surfaces, such as parking lots, that enters a CSS during wet weather.

Photo: Prince George's County, MD

Low-flow plumbing fixtures were installed in a 60-unit low income multi-family housing complex in Houston, Texas. The average number of occupants per unit was 4.4. Devices installed in each unit included low-flow toilets (1.6 gallons per flush), low-flow aerators on faucets (2.2 gallon per minute) and new water meters. Faucet leaks were repaired, and tenants were educated on conservation techniques. The project resulted in a reduction in average monthly water consumption for the complex from 1.3 MG pre-installation to 367,000 gallons post-installation. Average monthly water bills for the complex decreased from \$8,644 to \$1,810, resulting in savings of approximately \$6,834 each month. Due to the success of the project, Houston retrofitted four other low income housing developments with low-flow plumbing fixtures.

Water Conservation: Houston, TX

controls. Specifically, municipalities are asked to evaluate the applicability of more comprehensive collection system controls, storage facilities, and treatment technologies.

Sewer separation is the CSO control most widely implemented as part of an LTCP (EPA 2001a). Complete or limited sewer separation has been implemented or planned by the majority of CSO communities for which CSO controls were documented in the NPDES authority files that EPA reviewed as part of data collection to support its 2001 *Report to Congress—Implementation and Enforcement of the CSO Control Policy*. Other common CSO control measures identified in LTCPs include:

- Off-line storage facilities
- Plant modifications
- Sewer rehabilitation
- Disinfection facilities

8.2.2 Common SSO Control Measures

There is no national standard equivalent to the LTCP for communities with SSSs that are working to control SSOs, so it is difficult to determine the prevalence of specific controls. Based on interviews

EPA conducted to support the development of this report, it appears that communities with recurrent dry weather SSOs tend to rely on O&M activities, while communities with wet weather SSOs rely more heavily on collection system controls (e.g., inflow reduction, rehabilitation).

8.3 What Technology Combinations are Effective?

Most communities evaluate and use a wide variety of technologies for their CSO and SSO programs. Some technologies have proven to be advantageous when applied together. This section describes several examples of beneficial technology pairings; this list should not be construed as an exhaustive list of technology combinations.

8.3.1 Inflow Reduction or Low-Impact Development Coupled with Structural Controls

Inflow reduction and LID techniques reduce the quantity of storm water runoff that enters a sewer system. Since these controls can reduce both the peak flow rate and volume of storm water delivered to a sewer

system, the size of more capital-intensive downstream control measures, such as storage facilities or treatment technologies, can be reduced, or, in some cases, eliminated completely.

8.3.2 Disinfection Coupled with Solids Removal

A number of the pollutants present in wastewater can interfere with disinfection processes and reduce their efficacy. High concentrations of BOD₅, ammonia, and iron can reduce the effectiveness of disinfection. These substances can consume or otherwise prevent the disinfectant from reaching microbial pathogens. Solids in wastewater can also interfere physically with the disinfection process. Pathogens can be “shielded” by larger solids that surround and insulate microbial pathogens from the disinfectant (Hoff and Akin 1986). Physical interference can be significant for both chlorine and UV disinfection.

In general, solids removal enhances disinfection by removing interfering substances and by physically removing the pathogens themselves. The performance of disinfection facilities to treat CSO and SSO discharges can be improved through the use of technologies that provide solids control. Technologies with demonstrated abilities to remove solids include off-line storage facilities, vortex separators, and supplemental treatment facilities.

8.3.3 Sewer Rehabilitation Coupled with Sewer Cleaning

Sewer rehabilitation is undertaken to restore the structural integrity of sewers and reduce infiltration. The presence of debris and roots within sewer systems can limit the effectiveness of sewer rehabilitation efforts, particularly where Shotcrete or trenchless technologies are employed. Therefore, it is essential that sewer cleaning techniques are employed prior to any scheduled sewer rehabilitation efforts.

8.3.4 Real-Time Control Coupled with In-line or Off-line Storage Facilities

Real-time control technology is used to maximize storage within the collection system and maximize flow to the POTW, thereby reducing the volume and frequency of untreated discharges. Real-time control systems use monitoring data, operating rules, and customized software to operate system components (e.g., weirs, gates, dams, valves, and pumps) in a dynamic manner to optimize storage and treatment. Real-time control is most often applicable in CSSs, as these systems tend to have substantial in-line storage in large diameter pipes designed to transport excess wet weather flows. CSSs may also have off-line storage facilities (e.g., tunnels and basins), which can be incorporated into a real-time control strategy. The dynamic operation possible under real-time control tends to require less

storage than would be required for similar performance without real-time control.

8.4 What New Technologies for CSO and SSO Control are Emerging?

This section describes two different broad types of measures that have potential for widespread implementation in controlling the impacts of CSOs or SSOs. These controls are viewed as “emerging” for the following reasons: techniques are evolving and warrant further study; and, in general, applications to date have been limited to larger municipalities, although the technologies appear to have value for use in smaller systems. Again, this should not be construed to be an exhaustive list.

8.4.1 Optimization of Sewer System Maintenance

Sewer system maintenance is critical to providing safe and efficient service. Optimizing sewer system maintenance involves allocating labor, equipment, and materials to maximize system performance, so that the system can efficiently collect and transport wastewater to the treatment plant. Determining how much maintenance is enough is rarely straightforward, however. Currently, there is no standard approach for determining the optimal frequency of various maintenance procedures except through experience and professional

judgement (ASCE 1999). Several EPA regions and states, as well as professional organizations, have initiated efforts to develop such an approach. These include Region 4’s MOM Program (Section 7.3.1) and the toolkit of effective O&M practices recently published by WERF (WERF 2003a).

8.4.2 Information Management

Effective sewer system management largely depends on the availability of accurate, easily accessible data. Manual, paper-based data systems are used to some degree in all sewer systems (Arbour and Kerri 1998). Many utilities have been and continue to be operated and managed in an effective manner without the assistance of computer-based systems. The use of a computer system, however, can improve data storage and processing. Previously, the considerable expense of such systems limited their applicability to larger sewer systems. As the costs of computers and customized software have decreased, however, these systems are now available to most utilities (CSU 2002). An information management system can be designed to meet multiple needs, including:

- Simplifying maintenance planning and scheduling;
- Tracking workforce productivity;
- Developing accurate unit costs for specific maintenance activities;

- Measuring the impact of resource allocation to various maintenance activities; and
- Developing and tracking sewer system performance measures.

A number of vendors have designed software packages specifically to assist utility staff in sewer system management. The software is typically a tailored database program that

provides a means for efficient data organization, storage, and analysis. Most software packages include basic tools for sorting and filtering maintenance data; many also offer report generation capabilities. Other software packages contain basic tools as well as more advanced decision support systems. Most packages offer the ability to link to other external data systems such as a GIS or computer models.

Chapter 9

Resources Spent to Address the Impacts of CSOs and SSOs

This chapter responds to the congressional directive to report on the resources spent by municipalities to address environmental and human health impacts of CSOs and SSOs. The chapter presents information on historical investments in wastewater infrastructure, resources spent on CSO and SSO control to date, projected costs to reduce CSOs and SSOs, and financing mechanisms available to municipalities.

Most municipalities are not required to explicitly report costs to implement CSO and SSO controls. Therefore, financial information on resources spent to address CSOs and SSOs was drawn from alternative sources, including: LTCPs and other facility planning documents; municipal interviews described in Appendix C; information on state and local expenditures on wastewater infrastructure from the U.S. Census Bureau (2002, 2003a); specific reporting categories associated with the CWNS (EPA 2003b) and the CWSRF (EPA 2003j); other loan and grant programs; and federal, state, and

industry reports, such as the AMSA's triennial financial survey (AMSA 2003a).

All cost figures in this chapter are presented in 2002 dollars, unless otherwise noted. Unadjusted costs are included in Appendix M.

9.1 What Federal Framework Exists for Evaluating Resources Spent on CSO and SSO Control?

At the national level, two EPA programs provide information on the monies spent on CSO and SSO control, as well as anticipated needs:

- Clean Water State Revolving Fund (CWSRF)
- Clean Watersheds Needs Survey (CWNS)

The CWSRF is a national program established in 1987 under the Clean Water Act to fund water quality projects. Through the CWSRF, all 50 states and Puerto Rico maintain

In this chapter:

- 9.1 What Federal Framework Exists for Evaluating Resources Spent on CSO and SSO Control?
- 9.2 What are the Past Investments in Wastewater Infrastructure?
- 9.3 What Has Been Spent to Control CSOs?
- 9.4 What Has Been Spent to Control SSOs?
- 9.5 What Does it Cost to Maintain Sewer Systems?
- 9.6 What are the Projected Costs to Reduce CSOs?
- 9.7 What are the Projected Costs to Reduce SSOs?
- 9.8 What Funding Mechanisms are Available for CSO and SSO Control?

revolving loan funds to provide low-cost financing for these projects through low-interest loans. The CWSRF is primarily used to fund wastewater treatment projects, but it can also be used for nonpoint source pollution control and watershed and estuary management (EPA 2003j). The CWSRF tracks state and local expenditures on these projects on an annual basis, and it includes a separate reporting category for CSO expenditures.

The CWNS, a joint effort between states and EPA, includes a survey of needs of facilities for control of CSOs along with other wastewater and watershed needs (EPA 2003b). Survey data are maintained in a database and used to produce a CWNS Report to Congress, which provides a national estimate of needs. The CWNS and the CWSRF do not specifically track costs related to SSO control.

The CSO Control Policy provides a regulatory framework for CSO control. Under the CSO Control Policy, communities are required to develop and implement LTCPs. In developing an LTCP, the CSO Control Policy recommends that the community complete a detailed evaluation of CSO control alternatives and develop a financing plan to fund implementation of the selected controls. This means that communities that have completed LTCPs usually report the anticipated cost of CSO control in their plan.

The costs of addressing SSO problems can vary significantly among communities. Currently, there is no national framework for SSO control that requires communities to develop

and report projected or realized costs. Therefore, more financial information is available for CSOs than SSOs. For the purposes of this report, the costs to address SSOs were estimated using information from the CWSRF, the CWNS, and recent EPA efforts.

9.2 What are the Past Investments in Wastewater Infrastructure?

Municipalities, states, and the federal government have been investing in the nation's wastewater infrastructure since the late 19th century (EPA 2000a, 2000c). With passage of the Clean Water Act in 1972, investment in wastewater infrastructure increased markedly. The Clean Water Act dramatically increased funding for the Construction Grants Program, establishing a national policy to provide federal grants for the construction and upgrade of POTWs.

The Construction Grants Program provided grants for as much as 75 percent of the total capital cost for construction of wastewater treatment facilities from 1970 to 1995. During this period, the Construction Grants Program provided a total of more than \$100 billion in federal funding for new construction and POTW upgrades (EPA 2000a). In 1981, amendments to the Clean Water Act cut the authorization for POTW grants in half and reduced the maximum federal match to 55 percent. Legislation was amended to phase out the Construction Grants Program by 1991 and replace it with the CWSRF. Federal funding for the CWSRF totaled more than \$21 billion from

1988 to 2002, and states have made over \$47 billion available through the CWSRF for investment in wastewater infrastructure; both figures are in unadjusted dollars.

As shown in Figure 9.1, federal grant funding for capital wastewater projects peaked in 1977 at \$14.1 billion dollars. The U.S. Census Bureau (2002, 2003a) reported that total local and state spending on wastewater

infrastructure exceeded \$535 billion between 1970 and 2000. EPA estimates that the current capital investment in wastewater infrastructure from all public sources—federal, state, and local—is just over \$13 billion annually (EPA 2002a). Today, according to industry organizations, local governments and utilities pay as much as 90 percent of capital expenditures on wastewater infrastructure (AMSA and WEF 1999).

Figure 9.1

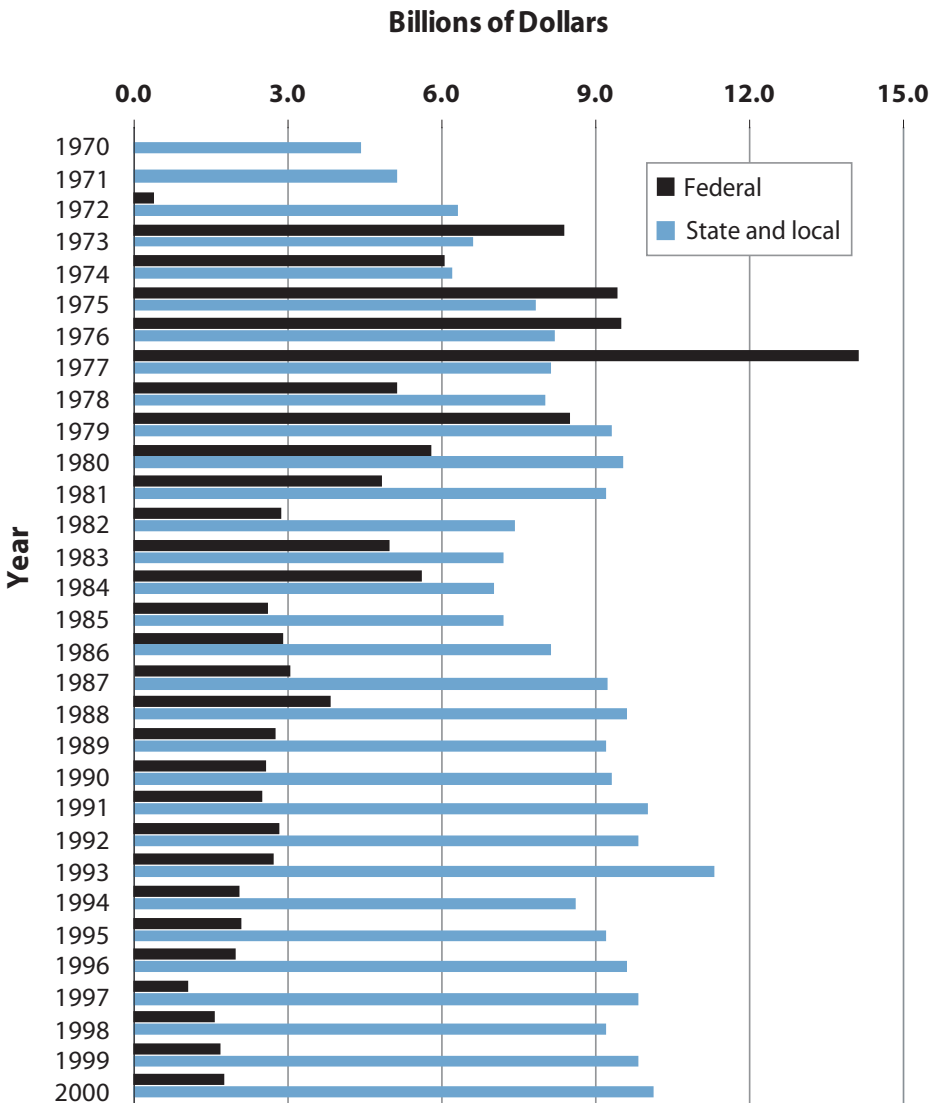

Annual Capital Expenditures on Wastewater Infrastructure, 1970-2000

Federal funding for capital wastewater projects peaked in 1977. At that time, federal funding accounted for more than 60 percent of annual capital expenditures on wastewater projects; by 2000, federal funding represented about 15 percent of annual capital expenditures. Details on annual federal, state, and local expenditures are shown in Appendix M (Tables M.2, M.3).

Sources: Construction Grants Program and CWSRF expenditures (EPA 2000a, 2000c, 2003j); and U. S. Census Bureau (2002).

As the value of the nation’s wastewater infrastructure increased, O&M (non-capital) expenditures at wastewater facilities have increased from \$1.3 billion in 1970 to \$18.0 billion in 2000 (Figure 9.2). O&M expenditures now account for 60 percent of total spending on wastewater services (U.S. Census Bureau 2003a). AMSA (2003b) cites a “combination of aging infrastructure, expectations of higher quality service, a growing population,

and increasingly expensive federal regulations” as contributing to increased O&M costs.

Since 1970, total public investment in wastewater infrastructure (capital) and O&M exceeded \$658.4 billion (EPA 2001f). According to ASCE, water and wastewater systems are the second largest public works infrastructure in the country (ASCE 2003). This infrastructure includes:

Figure 9.2

State and Local Expenditures on Wastewater O&M, 1970-2000 (EPA 2000c, U.S. Census Bureau 2002, 2003b)

The majority of O&M expenditures are borne by local governments. The Census Bureau does not, however, report state and local expenditures separately.

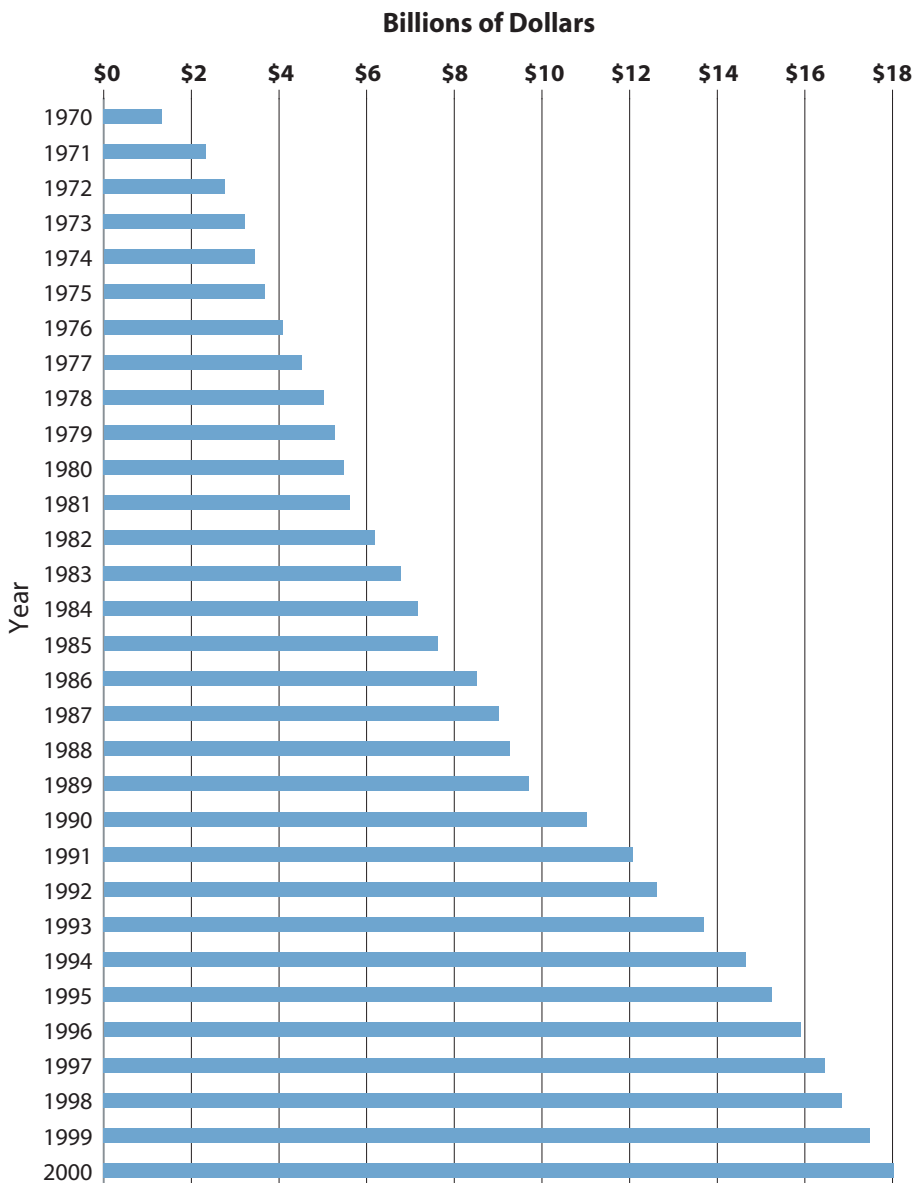

- 16,202 wastewater treatment facilities;
- 21,264 sewer systems (both CSS and SSS);
- 100,000 major pumping stations;
- 584,000 miles of sanitary sewers;
- 200,000 miles of storm sewers; and
- 140,000 miles of combined sewers (EPA 2001g and 2003b).

Construction Grants Program totaled \$3.4 billion.

Since 1988, the CWSRF has been used to provide loans to CSO communities. CSO projects financed under the CWSRF total \$3 billion (EPA 2003j). As shown in Figure 9.3, total state and local expenditures reported under the CWSRF program for CSO projects have increased to \$0.44 billion per year in 2002. The exact percentage of total annual municipal investment in CSO control projects funded through the CWSRF is not known. Some communities participate in the CWSRF for only a portion of their CSO financing; others do not participate in the program at all.

9.3 What Has Been Spent to Control CSOs?

Federal funding for CSO control projects began in 1965. Although some communities financed CSO controls through the Construction Grants Program, investment in wastewater infrastructure during the 1970s and 1980s was focused on POTW upgrades to secondary and advanced treatment and expansion (EPA 2001a). Federal funding for CSO projects through the

Statewide information on past expenditures for CSO control is available in some states. Two coordinated surveys were conducted in Michigan in 1999 to obtain community and state information on CSOs, SSOs, and other water pollution control efforts (SEMCOG

Billions of Dollars (2002)



Figure 9.3

CWSRF Annual Expenditures for CSO Projects, 1988 - 2002 (EPA 2003b)

This figure shows state and local expenditures reported under CWSRF Category V (CSO correction). Some communities participate in CWSRF for a portion of their CSO financing; other CSO communities do not participate at all.

HUD and CWSRF Funding Used to Fund Sewer Separation: Agawam, MA

The Town of Agawam, Massachusetts had 132 miles of combined sewer and found sewer separation to be a cost-effective CSO control. The town spent a total of \$5.85 million to implement CSO-control measures. Funding was provided through a Housing and Urban Development (HUD) grant in the 1970s for limited sewer separation. CWSRF loans provided \$2 million for a pump station upgrade (1996-1997) and \$3.5 million to complete the sewer separation (1999).

2001; PSC & ECT 2002). Capital CSO control expenditures by 63 Michigan communities exceeded \$1 billion between 1989 and 1999 (PSC & ECT 2002). It should be noted that few of Michigan’s CSO communities began implementing controls prior to 1989.

No comprehensive source of individual municipal expenditures for CSO control exists. Through this report effort, however, EPA compiled expenditures to date for 48 CSO communities (Appendix M). These expenditures total \$6 billion, ranging from \$134,000 to \$2.2 billion per community. Information on the unit costs of specific control technologies used by communities to reduce CSOs is available in the technology descriptions provided in Appendix L.

9.4 What Has Been Spent to Control SSOs?

Many of the expenditures associated with controlling SSOs are costs associated with renewing aging sewer system infrastructure. This makes separating costs specifically associated with SSO control from standard sewer system O&M costs difficult.

The CWSRF does not explicitly track expenditures related to SSO control. The CWSRF, however, does track “I/I correction” and “sewer system replacement and rehabilitation” expenditures. For the purposes of this report, these CWSRF categories of expenditures are used as a surrogate for SSO capital projects, with the understanding that they may

Figure 9.4

CWSRF Annual Expenditures for I/I and Sewer Replacement/Rehabilitation (EPA 2003j)

Although the CWSRF does not specifically track expenditures related to SSO control, spending related to I/I correction and sewer system replacement and rehabilitation may serve as a surrogate for SSO capital projects. These categories, however, may overestimate CWSRF expenditures on SSO control.

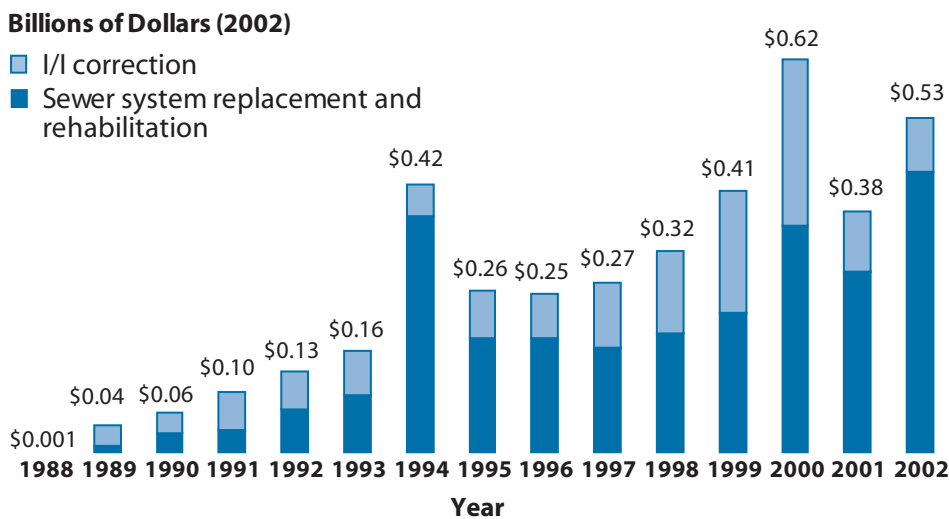

overestimate CWSRF expenditures on SSO control. As shown in Figure 9.4, total state and local spending through the CWSRF on I/I correction (Category III-A) and sewer system replacement and rehabilitation (Category III-B) was \$0.53 billion in 2002. From 1988 to 2002, expenditures totaled \$4.0 billion. Spending in these areas has increased over the last several years and now exceeds expenditures for CSO projects under the CWSRF program (EPA 2003j). It should be noted that communities may have reported expenditures on SSO projects under other categories, and not all communities participate in the CWSRF.

Some local cost information on expenditures to control SSOs was obtained as part of the municipal interviews conducted for this report (Appendix C). These communities had service populations ranging from 75 to 615,000 people. Of the 45 communities with SSSs that participated, 29 communities provided cost information on either capital or O&M annual expenditures on SSO control. As shown in Table 9.1, the total annual capital and O&M expenditures for these 29 communities totaled \$196.8 million. The total

annual expenditures varied with population served, from a minimum of \$20,000 in one small village to nearly \$96 million in a major metropolitan area.

The cost of SSO control can vary significantly, depending on the size and condition of the SSS, the technologies chosen to reduce SSOs, and regulatory requirements. Information on the unit costs of specific control technologies used by communities to reduce SSOs is available in the technology descriptions provided in Appendix L.

9.5 What Does it Cost to Maintain Sewer Systems?

As discussed in Section 9.2, the current capital investment by federal, state, and local sources in wastewater infrastructure is \$13 billion dollars per year. O&M costs exceed \$18 billion per year, more than 60 percent of total spending.

As shown in Table 9.2, average annual O&M costs per mile of sewer are highly variable. Various studies have estimated average O&M costs between \$3,100-\$12,500 per year per mile of

Type of Cost	Number of Communities	Minimum	Maximum	Total
Capital	19	\$6,000	\$75M	\$154.5M
O&M	26	\$12,500	\$20.9M	\$42.3M
Total (capital + O&M)	29	\$20,000	\$95.9M	\$196.8M

Table 9.1

Annual Expenditures in Sanitary Sewer Systems

This table shows annual capital and O&M expenditures for 29 communities with SSSs, which service populations ranging from 75 to 615,000.

Table 9.2

O&M Costs for Sewers

This table shows the average annual O&M costs per mile of sewer. Studies have found that O&M costs can vary widely.

Source	Annual Average O&M costs per mile	Range of O&M costs per mile
WERF (1997)	\$8,667	\$1,033 - \$51,051
ASCE (2000)	\$3,100	
WERF (2003)	\$12,503	
AMSA (2003a)	\$6,212	\$300 - \$57,000

sewer. A study commissioned by ASCE and EPA on optimizing maintenance of SSSs estimated that utilities should spend, on average, \$8,009 per mile annually (ASCE 1999). This study found that it is often difficult to develop comparable unit costs for different O&M techniques.

Communities participating in the interviews for this report also provided information on O&M expenditures. On average, these communities spent \$33,000 per mile of sewer per year on capital projects. O&M expenditures averaged \$7,886 per mile. These

findings are consistent with the aforementioned ASCE, WERF, and AMSA findings.

9.6 What are the Projected Costs to Reduce CSOs?

The CWNS is the primary source of data on anticipated capital needs for CSO control at the national level.

In the 2000 CWNS, EPA estimated future capital financial needs for CSO control at \$50.6 billion (2000

Sewer System Operation and Maintenance Costs: Santa Margarita Water District, CA

The Santa Margarita Water District in California serves 134,000 people, and owns and operates three wastewater treatment plants and 539 miles of SSSs; the District also maintains unknown miles of private laterals. The current O&M budget for sewer system work is approximately \$5 million a year, with more than one-third covering labor costs.

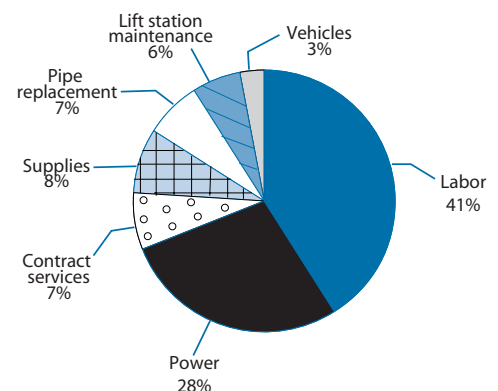

Sewer System Operation and Maintenance Costs: Somersworth, NH

The City of Somersworth, New Hampshire, maintains 24.4 miles of sewers. Prior to obtaining CWSRF for SSO projects, the city typically cleaned less than one mile of sewer each year. CWSRF funding was used to purchase a \$325,000 flushing truck. In 2002, the city was able to clean 15 miles of older sewer lines for \$140,000. The city currently anticipates spending at least \$15,000 per year on O&M. The city also anticipates spending \$100,000 to analyze the SSS and the separate storm sewer system and to enter that information into a GIS. These efforts have helped reduce the frequency of SSOs, which cost an average of \$1,200 per event for cleanup.

dollars). This estimate is based on LTCPs and CSO planning documents (which indicate varying levels of control) and a model used to estimate missing costs. Thirty-four facilities from 10 states documented CSO needs using LTCPs. These needs, totaling \$3.9 billion, account for 7.7 percent of the CSO needs reported in the CWNS. EPA also reviewed other materials (e.g., capital improvement program budgets) submitted by states as part of the CWNS process which documented municipal CSO needs. In compiling this information EPA found documentation of approximately \$16.7 billion in needs. The CWNS reports that a cost curve methodology was used to estimate the cost of CSO control where documented needs were not provided. The cost curve methodology is based on communities providing primary treatment and disinfection, where necessary, for no less than 85% of the CSO by volume. Compliance with current state water quality standards could, however, require a higher level of control resulting in additional needs.

Some organizations have compiled information at the state level on estimated capital needs for CSO control. Recent analyses conducted for Michigan estimated that \$1.7-\$3.4 billion will be needed for CSO communities in Michigan over the next 12 years (PSC & ECT 2002). Estimated costs to control CSOs in West Virginia exceed \$1 billion (Mallory 2003).

Community-specific information on projected CSO needs is available from several sources, including LTCPs, the *Report to Congress—Implementation*

and Enforcement of the Combined Sewer Overflow Control Policy (EPA 2001a) and the 2000 CWNS (EPA 2003c). Together, these sources provide information on the future capital needs for CSO control in 71 communities (see Appendix M).

Information on O&M costs for CSO control is not available at the national level.

9.7 What are the Projected Costs to Reduce SSOs?

The 2000 CWNS identified \$3.5 billion in I/I correction needs (Category III-A) for facilities reported by states as having SSO problems (EPA 2003b). A further \$10.4 billion in needs were reported for sewer system replacement or rehabilitation (Category III-B). The total needs for Category III-A and III-B were reported at \$8.2 and \$16.8 billion, respectively. Needs for Category III-A and III-B account for only 14 percent of the total CWNS. As shown in Figure 9.5, needs for Category III-A and III-B have more than doubled since the 1996 CWNS. This increase demonstrates that communities are planning for the correction of problems that are symptomatic of SSOs (EPA 2003b).

In addition to the documented needs, national modeled cost estimates for reducing SSOs to one overflow every five years for each SSS were prepared for the 2000 CWNS (EPA 2003b). EPA estimated that it would require \$88.5 billion in capital improvements to reduce the frequency of SSOs caused by wet weather and other conditions, such as blockages, line

Figure 9.5

Change in Estimated Needs Between 1996 and 2000 CWNS (EPA 2003b)

Between the 1996 and 2000 CWNS estimated needs related to I/I correction and sewer system replacement and rehabilitation have more than doubled, increasing by 122% and 118%, respectively.

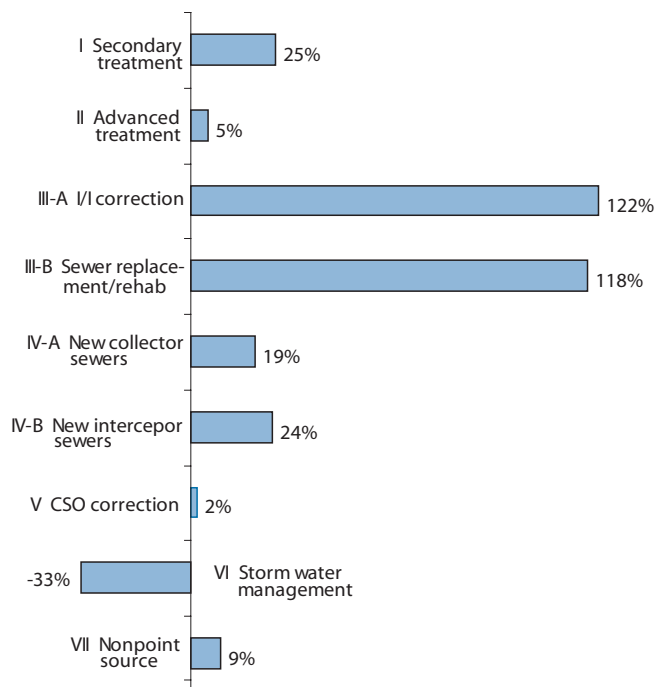

breaks, or mechanical/power failures. This estimate does not include costs associated with improved system management and O&M activities necessary to actually achieve the desired level of control. A case-by-case analysis of each SSS is needed to determine the actual level of investment required to control SSOs. EPA notes that these modeled needs should not be added to documented needs because the documented needs may already include costs to address SSOs.

SSSs, including newer systems, typically require significant, ongoing investment in O&M to reduce SSOs. O&M costs in individual communities vary significantly depending on community size, sewer system characteristics, local geology, and climate. EPA believes that needs will be greatest in communities that lack

regular preventive maintenance or asset management programs. EPA estimates that the gap between projected needs and current O&M spending over the next 20 years is between \$72 billion and \$229 billion (with a point estimate of \$148 billion), if current spending and operations practices are maintained. However, if municipalities increase spending at the rate of expected economic growth, the gap largely disappears (EPA 2002a).

9.8 What Funding Mechanisms are Available for CSO and SSO Control?

Significant capital and O&M expenditures are often required to control CSOs and SSOs. Detailed descriptions of various finance mechanisms and case studies can be found in EPA’s *SSO Fact Sheet Financing Capital Improvements for*

SSO *Abatement* (EPA 2003k) and in *CSO Guidance for Funding Options* (EPA 1995a). The following sections provide an overview of common financing options for capital projects, including self-financing, CWSRF loans, and federal and state grants. Financing options for debt repayment and O&M costs are more limited and often rely solely on self-financing.

9.8.1 Self-financing

Self-financing is the most common financing option used for CSO and SSO control. Self-financing relies on local revenue sources including:

- Fees – user charges, property taxes, hookup fees, development charges, assessments, permit fees, and special levies.
- Bonds – general obligation and revenue bonds.
- Other local income sources – reserves or fund transfers, interest payments, sales, and other mechanisms.

The *AMSA Financial Survey–2003* documents that local sources (i.e., fees, bonds, and other sources) have been used to fund between 90 and

95 percent of capital investment and operating funds for wastewater infrastructure between 1992 and 2001 (AMSA 2003a). The distribution of revenue sources based on AMSA’s most recent financial survey is presented in Figure 9.6.

AMSA’s recent financial survey notes that, when adjusted for inflation, residential service rates have decreased slightly since 1999, while rates for industrial customers have increased for some pollutants and decreased for others (AMSA 2003a). Specifically AMSA stated:

“The overall average residential sewer service charge from 1999 to 2002 rose 7.6 percent from \$216.02 to \$232.59 per year (\$19.38 per month) for a single-family residence (for common 1999 and 2002 survey respondents the increase was only 6.0 percent). Adjusting for inflation, average residential sewer rates have actually decreased by 0.3 percent from 1999 to 2002 (1.9 percent for common agencies). For industrial customers, inflation-adjusted rates for volume (in dollars per 1,000 gallon) and BOD have increased by 1 and 4 percent, respectively, since 1999, while inflation-adjusted rates for suspended solids have decreased by 2 percent from 1999 to 2002.”

Figure 9.6
Revenue Sources for Municipal Wastewater Treatment (AMSA 2003a)
 Self-financing is the most common option used to fund capital investments and O&M activities for wastewater treatment systems.

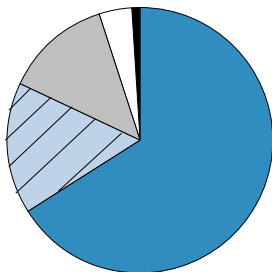

Revenue Sources	Percent
Local fees	66%
Other sources	16%
Bonds	13%
CWSRF loans	4%
Federal & state grants	1%
Total	100%

The costs associated with the control of CSOs and SSOs can be substantial and are likely to be borne mainly at the local level. Planning is needed to spread costs over time, as appropriate, in developing comprehensive, long-term programs.

9.8.2 State and Federal Funding for CSO and SSO Control

State and federal funding can offset some expenditures for capital projects needed to control CSOs and SSOs. A local match is typically required for state and federal funding, which can create debt repayment pressures for some communities (EPA 2002d).

Clean Water State Revolving Fund

CWSRF programs operate much like banks that are capitalized with state and federal contributions. CWSRF monies are loaned to communities for planning, design, and construction of environmental infrastructure. Loan repayments are recycled back into the program to fund additional projects.

The CWSRF is the federal government's major funding mechanism for financing capital improvements in wastewater infrastructure, including projects to address CSOs and SSOs. The CWSRF is used by states to provide loans at or below market interest rates, purchase existing local debt obligations, and guarantee local debt obligations. Loans are not available for O&M or other non-capital I/I reduction activities (e.g., downspout disconnection programs). As shown in Figure 9.7, the total expenditures under the CWSRF have increased since 1986, as has the amount being spent on CSO control (Category V) and on I/I correction and sewer repairs or rehabilitation (Category III-A and III-B, a proxy for SSO capital) projects.

Total assets of the CWSRF program exceed \$42 billion. States have significant control over the CWSRF funds. States set loan terms, including maximum loan amount, fees, interest rates (from zero percent to market

Figure 9.7

State and Local Expenditures Under the CWSRF Program for CSO Correction and SSO Capital Projects

Total expenditures under the CWSRF have generally increased since program inception in the late 1980s.

Billions of Dollars (2002)

- CSO correction
- SSO capital projects (I/I correction and sewer rehabilitation)
- All other CWSRF expenditures

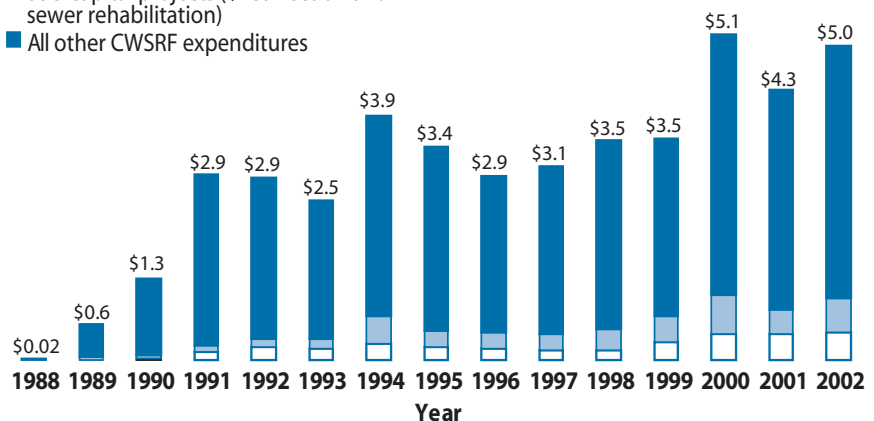

rate, sometimes on a sliding scale based on community economics), repayment periods (up to 20 years), requirements on repayment dollars, prioritization requirements, and many other features of the program. In some cases, legislative approval is required for changes. Twenty-six states are leveraging the federal funding by issuing bonds. States can also tailor their CWSRF programs to leverage a number of financing mechanisms to make funding opportunities more attractive for communities. Options include loans; refinancing, purchasing, or guaranteeing local debt; and purchasing bond insurance.

Federal Grants

As discussed in Section 9.3 of this report, federal water pollution control grants for CSO control were available as early as 1965. The federal Construction Grant Program was used extensively during the 1970s

and 1980s to fund construction of wastewater infrastructure, and several communities used this program to fund CSO projects. The program was phased out in the late 1980s in favor of the CWSRF.

Several other grant programs—the Rural Utilities Service Grant Program, the Economic Development Administration Grant Program, and Community Development Block Grants—also are used for CSO and SSO control projects, but they are only available to small and economically disadvantaged communities.

State Grants for CSO Control

Twenty-eight states have grant programs specifically to help communities implement CSO projects (EPA 2001a). These programs vary significantly in funding level and restrictions; many incorporate CWSRF loan funding. Most of these state programs are targeted at small

The City of Lawton, Oklahoma, is using CWSRF loans along with utility rate increases to fund rehabilitation and replacement of the SSS. The project is separated into three 7-year phases. The first phase ends in 2004. By establishing a Sanitary Sewer Technical Division for design in May 1998 and a Construction Division in January 1999, the city has been able to complete many of the tasks associated with this project on its own. While costs for Phase I were estimated to be \$22 million, actual costs held to \$16.8 million (see table below). This cost difference is the result of city efforts to use in-house designers and contractors. Actual costs for the remaining phases of this project are expected to be substantially lower.

Contract and Actual Costs for Lawton, OK SSS Rehabilitation Project

Phase	Contract Cost	Actual Cost	Projected Actual Cost	SRF Loan
I	\$22M	\$16.8M	--	\$15M
II	\$37M	--	\$28M	\$28M*
III	\$40M	--	**	--

* Lawton has qualified for this loan but has not borrowed the money yet.

** It is too early for a projected cost for Phase III.

CWSRF Loans Fund SSO Control: Lawton, OK



**State Grants for CSO Control:
Hartford and New Haven, CT**



Connecticut's state grant program for CSOs has provided \$173 million to eight communities. Without this funding, the City of Hartford would have been unable to proceed with CSO control, because independently the city could not issue \$80 million in debt. The state grant program also allowed the City of New Haven to meet its 12 to 15-year schedule for the LTCP, and the program kept user rates below EPA's affordability cap (EPA 2002d).

and/or economically disadvantaged communities, and often have fairly low funding levels.

States with grant programs for CSO control include Connecticut, Vermont, and Maine. Connecticut established a CSO grant program in 1986 that provides grants for 50 percent of the federal eligible project costs, and a CWSRF loan at 2 percent interest for the remaining costs. Vermont has a similar program that requires a 25 percent local match, provides a 25 percent grant for construction costs, and allocates CWSRF loans for the remainder. Maine has a state bond issue for \$2.4 million that funds grants awarded for 25 percent of the cost of development of CSO Master Plans, the functional equivalent of an LTCP.

State Grants for SSO Control

Oklahoma and North Carolina are examples of states with targeted grant programs, primarily aimed at making funding more readily available for rural areas, that have been used for SSO control projects. Oklahoma's Water Resources Board administers the CWSRF, provides low-interest bonds, and provides competitive funding through a Rural Economic Assistance Program (REAP). REAP provides grants between \$50,000 and \$100,000 for towns with populations between 500 and 1,000. The state has awarded 379 REAP grants for a total of \$32.7 million. North Carolina's General Assembly funded a program of grants called the High Unit Cost Program through issuance of state bonds in 1987 and again in 1993.

**State Grants for CSO Control:
Springfield and Rutland, VT**



Vermont's grant program helped the Town of Springfield make CSO projects more acceptable to voters. The town recently finished a \$4 million project for which it received \$1 million in state grant funds and a 50-percent loan at close to zero-percent interest. In Rutland, the Commissioner of Public Works also stated that grant funds were beneficial and helped keep user rates down (EPA 2002d).

**State Grants for SSO Control:
Nowata, OK**



Nowata, Oklahoma, secured \$250,000 from the Community Development Block Grant Program and \$79,000 from the Oklahoma REAP grant program to replace 7,000 feet of failing sanitary sewer line. Prior to receiving the grants, Nowata was able to replace 3,000 feet of sewer. The city plans to replace an additional 3,000 feet in the next five years. The grants represented a significant source of funding to the Maintenance Department, which operates with a \$190,000 annual budget.

Chapter 10

Conclusions and Future Challenges

This report has been prepared in response to a request by Congress for information related to CSOs and SSOs. EPA collected data and performed technical analyses to determine the environmental and human health impacts of CSOs and SSOs; the location, volume, frequency, and constituents of such discharges; the technologies used by municipalities to address CSOs and SSOs; and the resources spent by municipalities on CSO and SSO control.

In its preparation of this report, EPA found that:

- The occurrence of CSOs and SSOs is widespread. CSOs and SSOs contain pollutants that are harmful to the environment and human health, and there is evidence that CSOs and SSOs may cause or contribute to environmental and human health impacts.
- CSOs and many SSOs are caused by wet weather conditions and occur at the same time that storm

water and other nonpoint source pollutant loads are delivered to surface waters. This often makes it difficult to directly attribute specific water quality impacts to CSOs and SSOs. This suggests that a holistic approach should be used to address wet weather impacts.

- There are many existing structural and non-structural technologies that are well-suited for CSO and SSO control. Implementation of emerging technologies and improved information management hold promise for increased effectiveness and efficiency.
- Costs associated with the technologies for controlling CSOs and SSOs are often substantial. Planning is needed to spread costs over time, as appropriate, in developing comprehensive, long-term programs.

These findings are consistent with programmatic initiatives currently being implemented by EPA's Office of Water. They correspond with emerging needs and the findings

In this chapter:

Protecting Infrastructure

Implementing the Watershed Approach

Improving Monitoring and Information-Based Environmental Management

Building Strategic Partnerships

of other recent studies such as the National Water Quality Inventory, the BEACH Program, the Gap Analysis, and the Clean Watersheds Needs Survey. Further, they support EPA's position that discharges from urban areas—particularly wet weather discharges resulting from rainfall or snowmelt—continue to be significant contributors to water quality impairments nationwide.

Current challenges for clean water encompass CSO and SSO control, and include:

- Protection of existing infrastructure;
- Development, approval, and implementation of CSO LTCPs under the CSO Control Policy;
- Development and implementation of SSO controls;
- Implementation of Best Management Practices (BMPs) to reduce pollution from storm water runoff in accordance with EPA's Storm Water Phase I and II Programs;
- Integration of wet weather programs to increase the value of monitoring, reporting, tracking, and permitting to support information-based environmental management;
- Coordination of permits on a watershed basis; and
- Maintenance of valued partnerships with key stakeholder groups.

Several initiatives and actions that will enable EPA, states, municipalities, and citizens at large to achieve success in meeting these future challenges are described below.

Protecting Infrastructure

Since 1972, EPA has worked to implement the Clean Water Act as it relates to the collection, conveyance, and treatment of wastewater. The national investment in municipal wastewater infrastructure has been substantial. This investment has resulted in water quality and human health improvements throughout the United States. Today, however, the nation's wastewater infrastructure is aging and in need of attention. The continued ability of existing infrastructure to safeguard the clean water accomplishments realized since 1972 is at risk. Further, its ability to serve as the platform for future expansion of wastewater collection and treatment capacity is jeopardized.

Proper O&M of the nation's sewers is integral to ensuring that wastewater is collected, transported, and treated at POTWs; and to reducing the volume and frequency of CSO and SSO discharges. Municipal owners and operators of sewer systems and wastewater treatment facilities need to manage their assets effectively and implement new controls, where necessary, as this infrastructure continues to age. Innovative responses from all levels of government and consumers are needed to close the gap.

Implementing the Watershed Approach

CSOs and SSOs are two among many sources of pollution that can impact receiving water quality. The watershed approach is central to water quality assessments and the identification of control strategies that include all sources of pollution that affect water quality. The presence of sewer systems in most developed watersheds across the country underscores the potential for SSOs to affect water quality on a widespread basis. Similarly, the presence of CSOs in 32 states places

them in many watersheds across the country.

As described in this Report to Congress, CSOs and wet weather SSOs occur simultaneously with the generation of storm water and other forms of nonpoint source pollution, making it difficult to identify and assign specific cause-and-effect relationships to observed water quality problems. Attainment and maintenance of water quality standards requires that appropriate attention is given to all sources. Better integration of all of EPA's wet weather programs will provide for

Sanitation District No. 1 of Northern Kentucky received an EPA grant to work with the State of Kentucky to develop a watershed permitting approach and to investigate the feasibility of implementing the approach. The District includes Campbell, Kenton, and Boone counties, and covers an area of 580 square miles. Located on the southern bank of the Ohio River, directly across from Cincinnati, Ohio, this three-county area contains approximately 40 incorporated cities, each with its own political and administrative structure.

Prior to July 1995, the operation and maintenance of the sewer systems in these counties was the responsibility of the respective municipal jurisdictions. Ownership for most of the sewer systems in Northern Kentucky was transferred to the District in 1995 as a result of revisions to state legislation. With this consolidation, the District became responsible for managing 1,400 miles of combined and separate sanitary sewers, one major wastewater treatment facility, eight small wastewater treatment facilities, and approximately 100 CSO outfalls. Recently, with the development of a regional facilities plan, the District has embarked on a program to construct two new regional wastewater treatment facilities at a cost of more than \$200 million over the next 10 years. In addition, the District is responsible for implementing a CSO LTCP that includes an integrated watershed approach to planning and an SSO Plan (requested by the Kentucky Division of Water) to reduce the number of unauthorized discharges.

At this time, the District and the Kentucky Division of Water have agreed to pursue additional dialog on the development of a draft watershed permit for Banklick Creek. This watershed was selected because it is impacted by urban storm water runoff, CSOs, SSOs, septic systems, and rural runoff. It should be noted that the District's wastewater treatment plant does not discharge into the Banklick Creek watershed. The new watershed permit will enable the District to invest resources (time, labor, and money) more effectively in water quality improvement projects. The watershed permitting approach will also take advantage of the extensive database of water quality and GIS information that the District has compiled for its service area. Further, it provides an opportunity to consolidate monitoring and reporting activities.

Implementing the Watershed Approach: Kentucky



some economies of scale in achieving this end. Similarly, concentration of resources under the watershed approach will help advance the control of CSOs and SSOs in a cost-effective manner.

Improving Monitoring and Information-Based Environmental Management

In developing this Report to Congress, EPA found that the data necessary to answer many of Congress' questions were limited. Improved monitoring and reporting programs would provide better data for decision-makers to assess the frequency and magnitude of CSO and SSO events, the impact these discharges have on the environment and human health, and the importance of CSO and SSO discharges with respect to other pollution sources.

Numerous federal, state, and local government agencies as well as non-governmental organizations and

citizens are involved in monitoring. Monitoring and reporting efforts include collection of water quality information, tracking impacts of known activities affecting water quality, linking water quality to human health, and other activities. Effective monitoring programs provide the data and information needed to support sound decision making. Too often, however, the monitoring data do not meet the needs of specific programs or are not readily available. Better alignment of monitoring programs to address environmental management and human health issues is needed. Improved monitoring and reporting may foster a better understanding of cause-and-effect relationships. It may also improve state/local government and citizen access to environmental information.

Along with improved monitoring and reporting, data need to be effectively managed. Modernization of EPA's PCS will help in this regard. Use of standardized reporting formats for information on the occurrence

Improving Monitoring and Information-Based Environmental Management: Wisconsin

A cooperative effort between the Milwaukee Metropolitan Sewerage District (MMSD), the Wisconsin Department of Natural Resources, USGS, and several academic institutions resulted in the development of a single database for environmental data. The project team is compiling data sets from various federal, state, and local agencies in a centralized database of hydrology, water chemistry, macroinvertebrate, fish, habitat, and GIS information for stream corridors in the MMSD service area. The database is available on-line and allows the user to run queries and retrieve data currently in the system.

The database serves as a comprehensive inventory of stream corridor conditions, allowing for an improved understanding of the inter-relationship between the various types of data and establishing a baseline of existing conditions. Using these baseline conditions, impairments can be identified and assessed, and strategies can be developed to address the most significant problems. MMSD plans to use the database as a tool to prioritize future efforts to control CSO, SSO, and storm water discharges. Future data incorporated into the database will allow verification of improvements and identification of necessary adjustments or additional steps.

and control of CSOs and SSOs will enable EPA, states, and others to track pollutant loads and performance measures. Further, recent EPA efforts such as Watershed Assessment, Tracking, and Environmental Results (WATERS) are working to unite national water quality information that was previously available only from

several independent and unconnected databases.

Building Strategic Partnerships

The success that the nation has achieved in improving water quality since passage of the Clean Water Act is due to the

The Watershed Initiative for a Safer Environment (WISE) was started by the Cities of Elkhart, Mishawaka, and South Bend, Indiana. These cities have 102 CSO outfalls that discharge to 48 miles of the St. Joseph and Elkhart Rivers. Land use within the two-county area is 72 percent rural. Concentrations of *E. coli* in the main stem and at the mouths of the tributaries routinely exceed water quality standards. A single watershed tool was needed to educate the public and to assist in the selection of cost-effective strategies to reduce point and non-point pollutant sources, including CSOs. WISE utilized a stakeholder-driven approach to watershed planning involving numerous stakeholders, including:

- Indiana Department of Environmental Management
- City of Elkhart Public Works & Utilities
- City of Goshen Wastewater Utility
- City of Mishawaka Wastewater Utility
- City of South Bend Wastewater Utility
- Elkhart County Planning Division
- Jimtown Community School Corporation
- Juday Creek Task Force
- Local Farm Bureau Agency
- Michiana Area Council of Governments
- St. Joseph County Area Plan Commission
- St. Joseph County Surveyor
- St. Joseph and Elkhart County Health Departments
- St. Joseph and Elkhart County Soil and Water Conservation Districts
- Concerned citizens

WISE secured federal funding through the Clean Water Act 205(j) grant program to conduct coordinated river sampling and to develop a calibrated water quality model of the two rivers. WISE also expects to receive a 104(b)(3) grant in January 2004 to continue development of the model, including:

- Isolating the sources of *E. coli*;
- Identifying additional types of appropriate controls;
- Displaying the anticipated improvements in river water quality from different source controls along with the cost for implementation; and
- Evaluating whether refined water quality standards are appropriate.

This work will provide a single model that can be used in NPDES programs to further refine contaminant sources and assist in the selection of cost-effective strategies toward meeting, and possibly refining, water quality standards.

Strategic Partnerships: Indiana



collective efforts of federal and state agencies, municipalities, industry, non-governmental organizations, and citizens. Maintenance and enhancing existing cooperation among these groups is essential to meet the challenges to clean water that lie ahead.

As described in this Report to Congress, threats to water quality and human health have numerous origins and sources; establishing direct cause-and-effect relationships is often difficult. The information necessary to manage water quality problems also comes from many sources.

EPA recognizes the value of working with stakeholders and has pursued a strategy of extensive stakeholder participation in its policy-making on CSO and SSO issues. This effort should continue to improve knowledge on the impacts of CSOs and SSOs. Similarly, as communities continue to implement CSO and SSO controls, further cooperation with municipal, industry, and environmental organizations is essential to ensure successful development and implementation of environmental programs.

References

- American Federation of State, County, and Municipal Employees (AFSCME). 2003. "Risky Business: An AFSCME Health and Safety Guide for Water and Wastewater Treatment Plant Workers." Retrieved October 3, 2003. <http://www.afscme.org/health/riskybtc.htm>.
- American Society of Civil Engineers (ASCE). 1997. *Manhole Inspection and Rehabilitation*. Prepared by the Committee on Manhole Rehabilitation of the Pipeline Division of ASCE. New York: ASCE.
- ASCE. 1999. Optimization of Collection System Maintenance Frequencies and System Performance. Prepared by Black & Veatch, LLP under EPA Cooperative Agreement No. CX 824902-01-0. Washington, DC: ASCE. Retrieved October 2, 2003. <http://www.asce.org/pdf/finalreport.pdf>.
- ASCE. 2000. *Protocols for Identifying Sanitary Sewer Overflows*. Prepared under EPA Cooperative Agreement No. CX826097-01-0.
- ASCE. 2003. "2003 Progress Report: An Update to the 2001 Report Card. Report Card for America's Infrastructure." Retrieved October 2, 2003. <http://www.asce.org/reportcard/pdf/fullreport03.pdf>.
- Association of Metropolitan Sewerage Agencies (AMSA) and Water Environment Federation (WEF). 1999. "The Cost of Clean." Retrieved March 1999. <http://www.amsa-cleanwater.org/pubs/cost/coc.pdf>.
- AMSA. 2003a. *The AMSA 2002 Financial Survey: A National Survey of Municipal Wastewater Management Financing and Trends*. Washington, DC: AMSA.
- AMSA. 2003b. "Why Not Water? Investing in the Nation's Clean Water Future." Retrieved October 2, 2003. <http://www.amsa-cleanwater.org/pubs/2003-05WhyNotWater.pdf>.
- Arbour, R., and K. Kerri. 1998. Collection Systems: Methods for Evaluating and Improving Performance. Prepared for EPA Office of Wastewater Management, under Grant No. CX924908-01-0. Sacramento, CA: California State University, Sacramento Foundation.
- Arizona Water Resource (AWR). 2001. Do Waterborne Pathogens Pose Risks to Wastewater Workers? Arizona Water Resource 9(6). <http://ag.arizona.edu/AZWATER/awr/julyaug01/feature1.html>.
- Atkinson, J.F., et al. 1994. *Model Data Requirements and Mass Loading Estimates for the Buffalo River Mass Balance Study (ARCS/RAM Program)*. Prepared for EPA Great Lakes National Program Office, Report No. EPA 905-R94-005.
- Baasel-Tillis, P., and J. Tucker-Carver. 1998. Garbage and sewage disposal from recreational boats. *Journal of Environmental Health* 61(4):8-18.
- Bitton, G. 1999. *Wastewater Microbiology*, 2nd edition. New York: Wiley-Liss.
- Bowers, F. 2001. New Jersey embraces national EPA guidelines for management of onsite septic systems. *New Jersey Discharger* 9(3).
- Brammeier, J., Lake Michigan Federation. E-mail to Limno-Tech, Inc., July 29, 2003. Washington, DC.
- Brashear, R., et al. 2002. *Best Practices for Treatment of Wet Weather Wastewater Flows*. Alexandria, VA: Water Environment Research Foundation.
- Burger, J., et al. 1999. Factors in exposure assessment: ethnic and socioeconomic differences in fishing and consumption of fish caught along the Savannah River. *Risk Analysis* 19(3):427-438.

- Cabelli, V.J., et al. 1982. Swimming-associated gastroenteritis and water quality. *American Journal of Epidemiology* 115:606-616.
- Cabelli, V.J., et al. 1983. A marine recreational water quality criterion consistent with indicator concepts and risk analysis. *Journal of Water Pollution Control Federation* 55(10): 1306-1314.
- California State University (CSU) Sacramento. 2001. *Operation and Maintenance of Wastewater Collection Systems*. Volume I, 5th ed. Prepared for EPA, Office of Water Programs Operations. Sacramento, CA: California State University, Sacramento Foundation.
- CSU Sacramento. 2002. *Operation and Maintenance of Wastewater Collection Systems*. Volume II, 5th ed. Prepared for EPA, Office of Water Programs Operations. Sacramento, CA: California State University, Sacramento Foundation.
- California State Water Resources Control Board (CASWRCB). 2001. "California Beach Closure Report 2000." Retrieved September, 2003. <http://www.swrcb.ca.gov/beach/report/2000/report2000.pdf>.
- Centers for Disease Control and Prevention (CDC). 1983. Epidemiological notes and reports: Gastrointestinal illness among scuba divers— New York City. *Morbidity and Mortality Weekly Report* 32(44): 576-577.
- CDC. 1988. Water-related disease outbreaks, 1985. *Morbidity and Mortality Weekly Report* 37(SS-02): 15-24.
- CDC. 1990. Waterborne disease outbreaks, 1986-1998. *Morbidity and Mortality Weekly Report* 39 (SS-01): 1-9.
- CDC. 1992. Publication of CDC Surveillance Summaries. *Morbidity and Mortality Weekly Report* 41(SS-05):85-87.
- CDC. 1993. Surveillance for waterborne disease outbreaks— United States, 1991-1992. *Morbidity and Mortality Weekly Report* 42(SS-05): 1-22.
- CDC. 1995. Epidemiologic notes and reports of multistate outbreak of viral gastroenteritis associated with consumption of oysters— Apalachicola Bay, Florida, December 1994 - January 1995. *Morbidity and Mortality Weekly Report* 44(2):37-39.
- CDC. 1996a. Surveillance for waterborne disease outbreaks – United States, 1993-1994. *Morbidity and Mortality Weekly Report* 45(SS-01): 1-33.
- CDC. 1996b. Surveillance for foodborne-disease outbreaks - United States, 1988-1992. *Morbidity and Mortality Weekly Report* 45(SS-05): 1-55.
- CDC. 1997. Viral Gastroenteritis Associated with Eating Oysters - Louisiana, December 1996-January 1997. *Morbidity and Mortality Weekly Report* 46(47):1109-1112.
- CDC. 1998. Surveillance for waterborne-disease outbreaks— United States, 1995-1996. *Morbidity and Mortality Weekly Report* 47(SS-05): 1-34.
- CDC. 2000. Surveillance for waterborne-disease outbreaks— United States, 1997-1998. *Morbidity and Mortality Weekly Report* 49(SS-04): 1-35.
- CDC. 2002. Surveillance for waterborne-disease outbreaks— United States, 1999-2000. *Morbidity and Mortality Weekly Report* 51(SS-08): 1-28.
- Center for Marine Conservation (CMC). 1998. *1998 Coastal Cleanup— United States*. Washington, DC: CMC.
- Cheung, W.H.S., et al. 1990. Health effects of beach water pollution in Hong Kong. *Epidemiology and Infection* 105:139-162.
- Citizens Environmental Research Institute (CERI). 1999. *Assessment Strategy for Evaluating the Environmental and Health Impacts of Sanitary Sewer Overflows from Separate Sanitary Sewers*. Prepared under EPA Cooperative Agreement No. CX-824848-01-1.
- City of Indianapolis. 2000. *Improving Our Streams in the City of Indianapolis: A Report on Options for Controlling Combined Sewer Overflows*. Prepared by Camp Dresser & McKee, Inc., Greeley and Hansen Engineers, and Perras and Associates. Indianapolis, IN: City of Indianapolis Department of Public Works. http://www.indygov.org/dpw/cso/cso_report/index.pdf.
- City of Toledo. 2003. *Draft Industrial Wastewater Release Minimization Plan*. Draft report submitted to EPA Region 5.

- Clifton, C., San Diego County Department of Environmental Health. Interview by SRA, November 12, 2002. Arlington, VA.
- Congressional Budget Office (CBO). 2002. "Future Investment in Drinking Water and Wastewater Infrastructure." Retrieved October 2, 2003. <http://www.cbo.gov/showdoc.cfm?index=3983&sequence=0>.
- Connecticut Council on Environmental Quality (CTCEQ). 2002. *Environmental Quality in Connecticut: The 2001 Annual Report of the Council on Environmental Quality*. Hartford, CT: CTCEQ. <http://www.ct.gov/ceq/LIB/ceq/20/7/ar2001.pdf>.
- Corbett, S. J., et al. 1993. The health effects of swimming at Sydney beaches. *American Journal of Public Health* 83:1701-1706.
- Cordell, H.K., et al. 1999. *Outdoor Recreation Participation Trends. In Outdoor Recreation in American Life: A National Assessment of Demand and Supply Trends*, ed. H.K. Cordell, et al. pp. 219-321. Champaign, Illinois: Sagamore Publishing.
- Curtis, N. M., and A. H. Krustsch. 1995. Trying on Flow Reduction for Size. *Water Environment Technology* 3(No. 4): 48.
- D'Antonio, R.G., et al. 1985. A waterborne outbreak of cryptosporidiosis in normal hosts. *Annals of Internal Medicine* 103(6):886-888.
- Dennison, S., Metropolitan Water Reclamation District of Greater Chicago. E-mail to Limno-Tech, Inc., September 8, 2003. Washington, DC.
- DePinto, J.V., et al. 1995. "Application of Mass Balance Modeling to Assess Remediation Options for the Buffalo River (ARCS/RAM Program)." Final Technical Report for Cooperative Agreement No. CR-X995915 to U.S. EPA, Great Lakes National Program Office, Chicago, IL. Report No. EPA 905-R95-007.
- District of Columbia Water and Sewer Authority (DCWASA). 2002. *Combined Sewer System Long Term Control Plan: Final Report*. Washington, DC: Greeley and Hansen LLC.
- Dowes, J., et al. 2001. Work-related symptoms in sewage treatment workers. *Annals of Agricultural and Environmental Medicine* 8:39-45.
- EPA. 1983a. *Water Planning Division. Results of the Nationwide Urban Runoff Program - Final Report*. Vol. 1. EPA 832-R-83-112.
- EPA. 1983b. Office of Research and Development. *Health Effects Criteria for Marine Recreational Waters*. EPA 600-1-80-031.
- EPA. 1984a. Office of Research and Development. *Health Effects Criteria for Fresh Recreational Waters*. EPA 600/1-84-004.
- EPA. 1984b. Office of Water. *Regional and State Guidance on the National Municipal Policy*. No document number.
- EPA. 1985. Office of Municipal Pollution Control. *I/I Analysis and Project Certification*. EPA 832-F-85-100.
- EPA. 1986a. Office of Water. *Environmental Regulations and Technology: The National Pretreatment Program*. NTIS PB90-246521.
- EPA. 1986b. Office of Research and Development. *Design Manual: Municipal Wastewater Disinfection*. EPA 625-1-86-021.
- EPA. 1994a. Office of Water. *Combined Sewer Overflow (CSO) Control Policy*. EPA 830-94-001.
- EPA. 1994b. Office of Water. "NPDES Watershed Strategy." Retrieved September 26, 2003. <http://www.epa.gov/npdes/pubs/owm0109.pdf>.
- EPA. 1995a. Office of Water. *Combined Sewer Overflows Guidance for Funding Options*. EPA 832-B-95-007.
- EPA. 1995b. Office of Water. *Combined Sewer Overflows Guidance for Long-Term Control Plans*. EPA 832-B-95-002.
- EPA. 1995c. Office of Water. *Combined Sewer Overflows Guidance for Nine Minimum Control Measures*. EPA 832-B-95-003.
- EPA. 1995d. Office of Water. *Combined Sewer Overflows Guidance for Permit Writers*. EPA 832-B-95-008.
- EPA. 1995e. Office of Water. *Combined Sewer Overflows Screening and Ranking Guidance*. EPA 832-B-95-004.
- EPA. 1996a. Office of Water. "Watershed Approach Framework." Retrieved September 26, 2003. <http://www.epa.gov/owow/watershed/framework/>.
- EPA. 1996b. Office of Water. *U.S. EPA NPDES Permit Writer's Manual*. EPA 833-B-96-003.

- EPA. 1996c. Office of Enforcement and Compliance Assistance. "Setting Priorities for Addressing Discharges from Separate Sanitary Sewers." Retrieved October 1, 2003. <http://www.epa.gov/compliance/resources/policies/civil/cwa/ssodoc.pdf>.
- EPA. 1997a. Office of Water. 1996 *Clean Water Needs Survey Report to Congress*. EPA 832-R-97-003.
- EPA. 1997b. Office of Water. *State Source Water Assessment and Protection Programs-Final Guidance*. EPA 816-R-97-009.
- EPA. 1997c. Office of Water. Combined Sewer Overflows: Guidance for Financial Capability Assessment and Schedule Development. EPA 832-B-97-004. Retrieved October 8, 2003. <http://www.epa.gov/npdes/pubs/csoc.pdf>.
- EPA. 1999a. Office of Wastewater Management. Introduction to the National Pretreatment Program. EPA 833 B-98-002.
- EPA. 1999b. Office of Wastewater Management. Economic Analysis of the Final Phase II Storm Water Rule - Final Report. EPA 833 R-99-002.
- EPA. 1999c. Office of Science and Technology. *Review of Potential Modeling Tools and Approaches to Support the BEACH Program*. EPA 823-R-99-002.
- EPA. 1999d. Office of Water. *Drinking Water Treatment*. EPA 810-F-99-013.
- EPA. 1999e. Office of Water. *Combined Sewer Overflows Guidance for Monitoring and Modeling*. EPA 832-B-99-002.
- EPA. 1999f. Office of Water. *Combined Sewer Overflow Technology Fact Sheet: Inflow Reduction*. EPA 832-F-99-035.
- EPA. 1999g. Office of Water. *Preliminary Data Summary of Urban Storm Water Best Management Practices*. EPA 821-R-99-012.
- EPA. 1999h. Office of Water. *Storm Water Technology Fact Sheet: Porous Pavement*. EPA 832-F-99-023.
- EPA. 1999i. Office of Water. *Storm Water Technology Fact Sheet: Bioretention*. EPA 832-F-99-012.
- EPA. 2000a. Office of Water. *Progress in Water Quality: An Evaluation of the National Investment in Municipal Wastewater Treatment*. EPA 832-R-00-008.
- EPA. 2000b. Office of Enforcement and Compliance Assistance. "Compliance and Enforcement Strategy Addressing Combined Sewer Overflows and Sanitary Sewer Overflows." Retrieved October 4, 2003. <http://www.epa.gov/compliance/resources/policies/civil/cwa/strat312.pdf>.
- EPA. 2000c. Office of Water and Office of Policy, Economics, and Innovation. *A Retrospective Assessment of the Costs of the Clean Water Act: 1972 to 1997*. Final Report. Prepared by Research Triangle Institute, Center for Economics Research. EPA Contract No. 67-W7-0018.
- EPA. 2001a. Office of Water. *Report to Congress-Implementation and Enforcement of the Combined Sewer Overflow Control Policy*. EPA 833-R-01-003.
- EPA. 2001b. Office of Water. *Guidance: Coordinating Combined Sewer Overflow (CSO) Long-Term Planning with Water Quality Standards Reviews*. EPA 833-R-01-002.
- EPA. 2001c. Office of Water. "Financing Capital Improvements For SSO Abatement." Retrieved August 8, 2003. <http://www.epa.gov/npdes/ssofinance/index.htm>
- EPA. 2001d. Office of Water. *Source Water Protection Practices Bulletin: Managing Pet and Wildlife Waste to Prevent Contamination of Drinking Water*. EPA 916-F-01-027.
- EPA. 2001e. Office of Water. *Protocol for Developing Pathogen TMDLs, first edition*. EPA 841-R-00-002.
- EPA. 2001f. Office of Water. *Financing America's Clean Water Since 1987: A Report of Progress and Innovation*. EPA 832R-00-011.
- EPA. 2001g. Office of Wastewater Management. "What Wastewater Utilities Can Do Now to Guard Against Terrorist and Security Threats." Retrieved October 2, 2003. <http://www.epa.gov/npdes/pubs/wastewaterutilityfactsheet.pdf>.
- EPA. 2002a. Office of Water. *The Clean Water and Drinking Water Infrastructure Gap Analysis*. EPA 816-R-02-020.
- EPA. 2002b. Office of Water. *Summary of the August 14-15, 2002 Experts Workshop on Public Health Impacts of Sewer Overflows*. EPA 833-R-02-002.
- EPA. 2002c. Office of Water. *National Water Quality Inventory: 2000 Report to Congress*. EPA 841-R-02-001.

- EPA. 2002d. Office of Inspector General. *Evaluation Report – Wastewater Management: Controlling and Abating Combined Sewer Overflows*. EPA 2002-P-00012.
- EPA. 2002e. Office of Water. “Public Drinking Water Systems Program.” Retrieved November 24, 2002. <http://www.epa.gov/safewater/pws/pwss.html>.
- EPA. 2002f. Office of Water. *List of Contaminants & Their MCLs*. EPA 816-F-02-013.
- EPA. 2002g. Office of Water. *Implementation Guidance for Ambient Water Quality Criteria for Bacteria*. May 2002 Draft. EPA 823-B-02-003.
- EPA. 2002h. Office of Prevention, Pesticides, and Toxic Substances. “National Pollution Prevention Policy Definitions.” Retrieved November 22, 2002. <http://www.epa.gov/p2/p2policy/definitions.htm>.
- EPA. 2002i. Office of Research and Development. *Time-Relevant Beach and Recreational Water Quality Monitoring and Reporting*. EPA 625-R-02-0017.
- EPA. 2003a. Office of Water. *EPA’s BEACH Watch Program: 2002 Swimming Season*. EPA 823-F-03-007.
- EPA. 2003b. Office of Water. 2000 Clean Watershed Needs Survey Report to Congress. EPA 832-R-03-001.
- EPA. 2003c. Office of Water. Watershed-based NPDES Permitting Implementation Guidance. EPA 833-B-03-004.
- EPA. 2003d. Office of Water. “Water Quality Trading Policy.” Retrieved September 26, 2003. <http://www.epa.gov/owow/watershed/trading/finalpolicy2003.pdf>.
- EPA. 2003e. Office of Water. “Memorandum: Watershed-Based National Pollutant Discharge Elimination System (NPDES) Permitting Policy Statement.” Retrieved September 26, 2003. <http://www.epa.gov/npdes/pubs/watershed-permitting-policy.pdf>.
- EPA. 2003f. *National Risk Management Research Laboratory. Evaluating Cryptosporidium and Giardia in Combined Sewer Overflows as a Threat to Drinking Water Supplies*. Poster presented at EPA Science Forum 2003, Washington, DC. May 5-7, 2003.
- EPA. 2003g. Offices of Water and Research and Development. *Voluntary National Guidelines for Management of Onsite and Clustered (Decentralized) Wastewater Treatment Systems*. EPA 832-B-03-001.
- EPA. 2003h. Office of Water. *Protecting Water Quality from Urban Runoff*. EPA 841-F-03-003.
- EPA. 2003i. Office of Water. *CAFO notice of proposed rulemaking*. Federal Register 68, No. 29, February 12, 2003.
- EPA. 2003j. Office of Water. “Clean Water State Revolving Fund (CWSRF) National Information Management System Reports.” Retrieved July 15, 2003. <http://www.epa.gov/r5water/cwsrf/>
- EPA. 2003k. Office of Water. “SSO Fact Sheet: Financing Capital Improvements for SSO Abatement.” Retrieved April 22, 2003. <http://www.epa.gov/npdes/ssso/finance/index.htm>.
- EPA. 2003l. Office of Water. “Summary of Water Infrastructure Forum from the Closing the Gap: Innovative Solutions for America’s Water Infrastructure.” Retrieved October 2, 2003. www.epa.gov/water/infrastructure/forum_summary.html.
- EPA and USDA. 1998. “Clean Water Action Plan: Restoring and Protecting America’s Waters.” Retrieved September 2003. <http://www.cleanwater.gov/action/cwap.pdf>.
- Ferley, J. P., et al. 1989. Epidemiological significance of microbiological pollution criteria for river recreational waters. *International Journal of Epidemiology* 18(1):198-205.
- Fish and Wildlife Service (FWS). 2003. “The Clean Vessel Act.” Retrieved December 2003. http://federalaid.fws.gov/cva/cva_info.html.
- Fleisher, J.M., et al. 1996. Marine waters contaminated with domestic sewage: Nonenteric illnesses associated with bather exposure in the United Kingdom. *American Journal of Public Health* 86:1228-1234.
- Fleisher, J.M., et al. 1998. Estimates of the severity of illnesses associated with bathing in marine recreational waters contaminated with domestic sewage. *International Journal of Epidemiology* 27:722-726.
- Ford, T. 1994. Pollutant effects on the microbial ecosystem. *Environmental Health Perspectives* 102(12):45-48.

- Freeman, K. 2001. Too dangerous to dip? Marine pollution makes swimmers sick. *Environmental Health Perspectives* 109:A-332.
- Frost, F.J., et al. 1995. Waterborne disease surveillance: findings of a survey of state and territorial epidemiology programs. *Journal of Environmental Health* 58:6-11.
- Geldreich, E.E., et al. 1992. Searching for a water supply connection in the Cabool, Missouri disease outbreak of *Escherichia coli* 0157:H7. *Water Research* 26(8):1127-1137.
- General Accounting Office (GAO). 2002. *Water Infrastructure: Information on Financing, Capital Planning, and Privatization*. GAO-02-764.
- Gerba, C.P., et al. 1996. Sensitive populations: who is at the greatest risk? *International Journal of Food Microbiology* 30:113-23.
- Graczyk, T.K., et al. 1998. *Giardia* sp. Cysts and infectious *Cryptosporidium parvum* oocysts in the feces of migratory Canada geese. *Applied and Environmental Microbiology* 64(7): 2736-2738.
- Green Building Services (GBS). October 10, 2002. "Green Technology Brief: Water Conservation." Retrieved July 14, 2003. http://www.greenbuildingservices.com/green_resources/pdfs/WaterConWeb.pdf.
- Griffin D.W., et al. 2001. Marine recreation and public health microbiology: quest for the ideal indicator. *BioScience* 51(10): 817-825.
- Gurba, K., Boston Public Health Commission. Interview by SRA, October 4, 2002. Arlington, VA.
- Haile, R.W., et al. 1999. The health effects of swimming in ocean water contaminated by storm drain runoff. *Epidemiology* 10:357-393.
- Henrickson, S.E., et al. 2001. Marine swimming-related illness: Implications for monitoring and environmental policy. *Environmental Health Perspective* 109(7):645-650.
- Henry, L. 2003. Personal communication regarding Corps of Engineers spending on environmental infrastructure project No. 772 to US Army Corps of Engineers, May 28, 2003. Washington, DC.
- Hering, R. [1882] 1977. *Report of the Results of an Examination Made in 1880 of Several Sewerage Works in Europe*. Annual Report of the National Board of Health 1881. Reprint in *Sewering the Cities*, edited by Barbara Gutmann Rosenkrantz. New York: Arno Press.
- Hoff, J. C., and E. W. Akin. 1986. Microbial Resistance to Disinfectants: Mechanisms and Significance. *Environmental Health Perspectives* 69: 7-13.
- Hoxie N.J., et al. 1997. Cryptosporidiosis-associated mortality following a massive waterborne outbreak in Milwaukee, Wisconsin. *American Journal of Public Health* 87: 2032-2035.
- Jones & Henry Engineers. 1997. *Combined Sewer Overflow Impact Report*. Report submitted to City of Toledo, Ohio.
- King County Department of Natural Resources (KCDNR). 1999. *King County Combined Sewer Overflow Water Quality Assessment for the Duwamish River and Elliot Bay*. Seattle, WA: Wastewater Treatment Division, KCDNR.
- Kolpin, D. W., et al. 2002. Pharmaceuticals, hormones, and other organic wastewater contaminants in U.S. streams, 1999-2000: A National Reconnaissance. *Environmental Science and Technology* 36:1202-1211.
- Kueh, C.S.W., et al. 1995. Epidemiological study of swimming-associated illnesses relating to bathing-beach water quality. *Water Science and Technology* 31(5-6):1-4.
- Kümmerer, K. 2001. *Pharmaceuticals in the Environment: Sources, Fate, Effects and Risks*. Heidelberg, Germany: Springer-Verlag.
- Kurtz, J., Douglas County, NE Health Department. Interview by SRA, November 21, 2002. Arlington, VA.
- Laurenson, J.P., et al. 2000. *Risk of waterborne infectious disease in children with normally developing immune systems*. Published in the proceedings of the Society for Risk Analysis 2000 Annual Meeting, December 3-6, 2000. Arlington, VA: Society for Risk Analysis.
- Leeworthy, V.R., et al. 2001. *National Survey on Recreation and the Environment (NSRE) 2000 - NAS*. Preliminary Estimates from Versions 1-6: Coastal Recreation Participation. Silver Spring, MD: National Oceanic and Atmospheric Administration. Retrieved October 3, 2003. http://www.marineconomics.noaa.gov/NSRE/NSRE_V1-6_May.pdf.

- Ljungstrom, I., and B. Castor. 1992. Immune response to *Giardia lamblia* in waterborne outbreak of giardiasis in Sweden. *Journal of Medical Microbiology* 36(5):347-352.
- Loganathan, B.G., et al. 1997. Distribution of Selected PCB Congeners to Identify PCB Sources in Combined Sewer Overflows (CSOs) Discharging to the Buffalo River, New York. *Archives of Environmental Contamination and Toxicology* 33:130-140.
- Lue-Hing, Cecil. 2003. Sanitary Sewer Overflows in the Knoxville Utilities Board (KUB) Service Area: A Review of the Health Aspects.
- Luke, J., New York State Department of Health. Interview by SRA, November 7, 2002. Arlington, VA.
- Lyon, T., and R. Nelson. 2002. Sewer design practices - Are we using the right criteria or creating more SSOs? *Water Environment and Technology* 14(No. 3).
- Mallory, K., West Virginia Infrastructure & Jobs Development Council (WVIJDC). Interview by Limno-Tech, Inc., May 17, 2003. Ann Arbor, MI.
- Manny, B.A., et al. 1994. Nutrient addition by waterfowl to lakes and reservoirs—predicting their effects on productivity and water quality. *Hydrobiologia* 280: 121-132.
- May, H., and J. Burger. 1996. Fishing in a polluted estuary: fishing behavior, fish consumption, and potential risk. *Risk Analysis* 16(4):459-471.
- Mazur, M., Orange County Health Care Agency. Interview by SRA, November 12, 2002. Arlington, VA.
- Mazur, M., Orange County Health Care Agency. E-mail forwarded to Limno-Tech, Inc., June 26, 2003. Washington, DC.
- McCuin, R.M. and Clancy, J.L. 2004. *Cryptosporidium* Occurrence, Removal and Inactivation Methods for Wastewaters. Final Report: Water Environment Research Foundation, Project 98-HHE-1, Alexandria, VA. In press.
- Melosi, M. V. 2000. *The Sanitary City: Urban Infrastructure in America from Colonial Times to the Present*. Baltimore, MD: The Johns Hopkins University Press.
- Metcalf and Eddy, Inc. 2003. *Wastewater Engineering: Treatment, Disposal, and Reuse*. 4th ed. Boston: Irwin McGraw Hill.
- Metropolitan Water Reclamation District of Greater Chicago (MWRD). 1998. *A Study of the Fisheries Resources and Water Quality in the Chicago Waterway System 1974 Through 1996*. Chicago, IL: MWRD.
- MWRD. 2003. *Protecting Lake Michigan Water Quality*. Report No. 03-12-A. Chicago, IL: MWRD.
- Meyland, S.J., et al. 1998. "Monitoring and Assessing the Environmental and Health Risks of Separate Sanitary Sewer Overflows (SSOs)." Presented at National Water-Quality Monitoring Council National Monitoring Conference, Reno, Nevada. July 7-9, 1998.
<http://www.nwpmc.org/98proceedings/Papers/14-MEYL.html>.
- Moe, C.L., et al. 2000. "2000 Progress Report: Studies of Infectivity of Norwalk and Norwalk-like Viruses." Funded by EPA National Center for Environmental Research, under Grant No. R826139. Retrieved October 31, 2003.
<http://es.epa.gov/ncer/progress/grants/97/dwater/moe00.html>.
- Moffa, P. E. (editor). 1997. *Control and Treatment of Combined Sewer Overflows*. 2nd Edition. New York: Van Nostrand Reinhold.
- Murray, J. E., and J. M. Bona. 2001. *Rouge River National Wet Weather Demonstration Project*. Wayne County, MI.
<http://www.rougeriver.com/>
- National Academy of Sciences (NAS). 1993. *Managing Wastewater in Coastal Urban Areas*. Washington, DC: National Academies Press.
- NAS. 2000. *From Monsoons to Microbes*. Washington, DC: National Academies Press.
- National Oceanic and Atmospheric Administration (NOAA). 1997. *The 1995 National Shellfish Register of Classified Growing Waters*. Retrieved October 3, 2003.
<http://sposerver.nos.noaa.gov/projects/95register/>.
- National Research Council (NRC) Committee on the Use of Treated Municipal Wastewater Effluents and Sludge in the Production of Crops for Human Consumption. 1996. *Use of Reclaimed Water and Sludge in Food Crop Production*. Washington, DC: The National Academies Press.

- New Hampshire Department of Environmental Services (NHDES). 2000. *State of New Hampshire 2000 Section 305(b) Water Quality Report*. NHDES-WD-00-4. Concord, NH: NHDES.
- New Jersey Department of Environmental Protection (NJDEP). 2003. "Sayreville Sewage Spill Update." Retrieved October 2003. <http://www.state.nj.us/dep/update/update030603.html>.
- New York City Department of Environmental Protection (NYCDEP). January 1997. CSO Abatement in the City of New York: Report on Meeting the Nine Minimum CSO Control Standards. New York: NYCDEP, Bureau of Wastewater Pollution Control, Division of Water Quality Planning.
- New York-New Jersey Harbor Estuary Program (NYNJHEP). 1996. "New York-New Jersey Harbor Estuary Program Final Comprehensive Conservation and Management Plan." Retrieved October 3, 2003. <http://www.harborestuary.org/mgmt.htm>
- NYNJHEP. 2002a. "The Status of Shellfish Beds in the NY-NJ Harbor Estuary." Retrieved October 3, 2003. <http://www.harborestuary.org/pdf/hepsshellfish.pdf>.
- NYNJHEP. 2002b. *Harbor Health/ Human Health - An Analysis of Environmental Indicators for the NY/NJ Harbor Estuary*. Prepared by Hudson River Foundation for Science and Environmental Research under EPA Cooperative Agreement No. X-992957-01. http://www.harborestuary.org/archive/Ind_rpt_02.pdf.
- New York State Department of Environmental Conservation (NYSDEC). 1997. "Memorandum: SPDES Permit Development for POTWs," Appendix G. Retrieved September, 2003. <http://www.dec.state.ny.us/website/dow/togs/togs133.pdf>.
- NYSDEC. 2001. "Wet Weather Operating Practices for POTWs with Combined Sewers: Technology Transfer Document." Retrieved September, 2003. http://www.dec.state.ny.us/website/dow/bwcp/ww_techtran.pdf.
- North Carolina Department of Environment and Natural Resources (NCDENR). 2003. "Fish Kill Event Update." Retrieved October 2003. <http://www.esb.enr.state.nc.us/Fishkill/fishkillmain.htm>.
- Northern Virginia Planning District Commission (NVPDC). 2000. Press release on Four Mile Run Bacteria Sources Determined. October 26, 2001. Annandale, VA.
- Ocean Conservancy. 2003. "National Marine Debris Monitoring Program." Retrieved December 2003. <http://www.oceanconservancy.org/dynamic/learn/programs/debris/debris.htm>.
- Ocean Conservancy. 2004. "2003 International Coastal Cleanup Results." Retrieved July 2004. <http://www.coastalcleanup.org/results.cfm>.
- Orange County, California. 2002. 2001 Annual Ocean and Bay Water Quality Report. Orange County, CA: Healthcare Agency Environmental Health. <http://www.ocbeachinfo.com/downloads/2001oceanreport.pdf>.
- Palo Alto Regional Water Quality Control Plant (PARWQCP). 1999. *Copper Source Identification*. Prepared for EIP Associates. San Francisco, CA.
- Parametrix, Inc. 2001. *Facilities Plan: Central Wastewater Treatment Plant, City of Tacoma - Draft Final Edits*. Prepared for the City of Tacoma, Washington.
- Paulson, R.I., et al. 1984. Attacking private infiltration/inflow sources. *Public Works* 115 (2): 54-59.
- Payment, P. and E. Franco. 1993. Clostridium perfringens and Somatic Coliphages as Indicators of the Efficiency of Drinking Water Treatment for Viruses and Protozoan Cysts. *Applied and Environmental Microbiology* 59(8):2418-2424.
- Pioneer Valley Planning Commission (PVPC). 2002. "CSO Fact Sheet #5: Potential Strategies to Address CSO Cleanup." Retrieved October 2, 2003. http://www.pvpc.org/docs/landuse/cso/cso_facts.pdf.
- Pitt, R., et al. "National Stormwater Quality Database (NSQD, version 1.0)." Retrieved August 6, 2003. <http://www.eng.ua.edu/~rpittResearch/ms4/Paper/Mainms4paper.html>.
- Public Sector Consultants, Inc. and Environmental Consulting and Technology, Inc. (PSC & ECT). 2002. *Managing the Cost of Clean Water: An Assessment of Michigan's Sewer Infrastructure Needs*. Prepared for Clean Water Michigan. Retrieved October 2, 2003. <http://www.publicsectorconsultants.com/Documents/underground/cleanwater.pdf>.

- Reynolds, K.A. 2000. Identifying populations at greatest risk of waterborne disease. *Water Conditioning & Purification* 42(3). <http://www.wcp.net/archive/mar00ontap.htm>.
- Rose, J. B., et al. 1988. Correlations of the protozoa *Cryptosporidium* and *Giardia* with water quality variables in a watershed. *Water Science and Technology* 20:271-276.
- Rose, J.B., et al. 2001a. *Reduction of pathogens, indicator bacteria, and alternative indicators by wastewater treatment and reclamation processes*. Water Environment Research Foundation. Project Number 00-PUM-2T.
- Rose, J.B., et al. 2001b. Reduction of enteric microorganisms at the Upper Occoquan Sewage Authority Water Reclamation Plant. *Water Environment Research* 73(6): 711-720.
- Rowland, W.G., and A.S Heid. 1976. Water and the growth of the nation. *Journal of the Water Pollution Control Federation* 48(7):1682-1689.
- Schaub, S. 1995. *Human Health Concerns Associated with Microbiological Pathogens in Wastewaters During Wet Weather Events*. Washington, DC: EPA.
- Schultz, N., D. Meagher, and B. Cabibel. 2001. *Milwaukee's Experience in Collection System Controls*. *Proceedings of Water Environment Federation Specialty Conference 2001, A Collection System Odyssey, Bellevue, WA, July 2001*.
- Schvoerer, E., et al. 2001. Qualitative and quantitative molecular detection of enteroviruses in water from bathing areas and from sewage treatment plants. *Research Microbiology* 152:179-186.
- Sechena, R., et al. 1999. Asian and Pacific Islander Seafood Consumption Study. Funded by EPA Environmental Justice Community/University Partnership, under Grant No. EQ925003-01. EPA 910/R-99-003. <http://www.epa.gov/r10earth/offices/oea/risk/r0riskhh.htm>.
- Seeley, A., New York State Department of Environmental Protection. Interview by SRA, October 30, 2002. Arlington, VA.
- Seyfried, P.L., et al. 1984. Impact of sewage treatment plants on surface waters. *Canadian Journal of Public Health* 75:25-31.
- Sherrill, J.D., et al. 1997. *Rating and Optimization of Collection System Transport and Storage*. Presented at WEFTEC 1997 Conference, Chicago, IL. October 18-22, 1997.
- Snow, J. 1936. *Snow on Cholera, being a reprint of two papers by John Snow, MD [1894 and 1855]*. London, England: Oxford University Press.
- Southeast Michigan Council of Governments (SEMCOG). 2001. "Investing in Southeast Michigan's Quality of Life: Sewer Infrastructure Needs." Detroit, MI: SEMCOG. <http://www.semco.org/Products/pdfs/sewerneeds2.pdf>.
- States, S., et al. 1997. Protozoa in river water: sources, occurrence, and treatment. *Journal AWWA* 89(9): 74-87.
- Staudt, J., Austin-Travis Health Department. Interview by SRA, November 21, 2002. Arlington, VA. Storm Water Manager's Resource Center (SMRC). "Storm Water Management Fact Sheet: Porous Pavement." Retrieved October 25, 2002. <http://www.stormwatercenter.net>.
- Swerdlow, D.L., et al. 1992. A waterborne outbreak in Missouri of *Escherichia coli* 0157:H7 associated with bloody diarrhea and death. *Annals of Internal Medicine* 117:812-818.
- Sykora, J.L., et al. 1990. Distribution of *Giardia* cysts in wastewater. *Water Science Technology* 24:187-192.
- Tarr, J. A. 1996. *The Search for the Ultimate Sink: Urban Pollution in Historical Perspective*. Akron, OH: The University of Akron Press.
- Texas Department of Health (TDH). 1998. Cryptosporidiosis at Brushy Creek. *Epidemiology in Texas, 1999 Annual Report*. <http://www.tdh.state.tx.us/epidemiology/98annual/reports/crypto.pdf>.
- Toy, K.A., et al. 1996. *A fish consumption survey of the Tulalip and Squaxin Island tribes of the Puget Sound region*. Margsville, WA: Tulalip Tribes, Department of Environment.
- U.S. Census Bureau. 2002. 2002 Census of Governments, Volume 1, Number 1, Government Organization, GCO2(1)-1. Washington, DC: U.S. Government Printing Office. www.census.gov/prod/2003pubs/gco21x1.pdf.

- U.S. Census Bureau. 2003a. "Statistical Abstract of the United States." Section 8, State and Local Government. Retrieved December 2003. <http://www.census.gov/prod/www/statistical-abstract-us.html>.
- U.S. Census Bureau. 2003b. State and Local Government Finances, by Level of Government. Retrieved October 2003. <http://www.census.gov/govs/www/estimate.html>
- U.S. Geological Survey (USGS). 2001. Characterization of *E. coli* levels at 63rd Street Bridge. Lake Michigan Ecological Research Station. Porter, IN: USGS.
- USGS. 1999. *The Quality of Our Nation's Waters: Nutrients and Pesticides*. Circular 1225. U.S. Geological Survey: Reston, VA.
- USGS. 2002. Water Quality in the Mahoning River and Selected Tributaries. *Water Resources Investigation Report* 02-4122. Columbus, OH: USGS.
- University of Maryland, School of Public Affairs. May 2002. "Reducing Combined Sewer Overflows Toward Clean Water in Washington, DC." Retrieved August 6, 2003. http://www.puaf.umd.edu/faculty/papers/nelson/CSO_Complete.pdf.
- Vasquez, V., San Diego Regional Water Quality Control Board. E-mail to Limno-Tech, Inc., April 17, 2003. Washington, DC.
- Von Schirnding, Y.E.R., et al. 1992. Morbidity among bathers exposed to polluted seawater: a prospective epidemiological study. *South African Medical Journal* 81:543-546.
- Vonstille, W.T. 1993. Hepatitis A epidemics from utility sewage in Ocoee, Florida. *Archives of Environmental Health* 48(2):120-4.
- Wade, T.J., et al. 2003. Do USEPA water quality guidelines for recreational waters prevent gastrointestinal illness? A systematic review and meta-analysis. *Environmental Health Perspectives* 111(8): 1102-1109.
- Washington State Department of Health (WSDOH). 1996. "Zinc Fact Sheet." Retrieved December 2003. <http://www.doh.wa.gov/ehp/ts/zinc.doc>.
- WSDOH. 2002. "The Health of Washington State: Recreational Waterborne Illness." July 23, 2002. Retrieved September, 2003. http://www.doh.wa.gov/HWS/doc/EH/EH_WR.doc.
- WEF. 1999a. *Prevention and Control of Sewer System Overflows: WEF Manual of Practice No. FD-17*. Alexandria, VA: WEF.
- WEF. 1999b. *Control of Infiltration and Inflow in Private Building Sewer Connections*. Alexandria, VA: WEF.
- Water Environment Research Federation (WERF). 1997. *Benchmarking Wastewater Operations—Collection, Treatment, and Biosolids Management: Final Report*. Prepared by Patrick, R., et al. Project Number 96-CTS-5T. Alexandria, VA: WERF.
- WERF. 2000. *Assessing Methods of Removing Metals from Wastewater: A Review of Data and Methodologies*. Project 97-CTS-4. Alexandria, VA: WERF.
- WERF. 2001. *Wet Weather Flow Assessment Protocols*. Prepared by Moffa and Associates. Project 95-WWR-1A. Alexandria, VA: WERF.
- WERF. 2003a. *Effective Practices for Sanitary Sewers/Collection Systems Operations and Maintenance*. Prepared by Nelson R., et al. Project Number 01-CTS-20-T. Alexandria, VA: WERF.
- WERF 2003b. *Waterborne Infectious Pathogens in Wastewater: Determination of Presence, Survivability, and Risks to Wastewater Treatment Plant and Collection System Workers*. Prepared by M. Samadpour. Project Num. 99-HHE-4. Alexandria, VA: WERF.
- Wilson, N.D., et al. 1998. The effect of cooking practices on the concentration of DDT and PCB compounds in the edible tissue of fish. *Journal of Exposure Analysis and Environmental Epidemiology* 8(3):423-440.
- Wisconsin Department of Natural Resources (WDNR). 2001. *Sewer Overflows in Wisconsin - A Report to the Natural Resources Board*. Madison, WI: WDNR. t 97-CTS-4. Alexandria, VA:WERF.
- World Health Organization Sustainable Development and Healthy Environments (WHO). 2001. *Bathing Water Quality and Human Health*. WHO/SDE/WSH/01.2.
- Yates, M.V. 1994. *Monitoring concerns and procedures for human health efforts*. In: *Wastewater Reuse for Golf Course Irrigation*. Ann Arbor: Lewis Publishers.

Yates, M.V., and C. P. Gerba,
1998. Microbial considerations in
wastewater reclamation and reuse.
Wastewater Reclamation and Reuse
Vol. 10. T. Asano (Ed.). Lancaster, PA:
Technomic Publishing Company, Inc.

Appendix A

Statutes, Policies, and Interpretive Memoranda

A.1 Consolidated Appropriations Act
for Fiscal Year 2001 (P.L. 106-554)

A.2 Combined Sewer Overflow
(CSO) Control Policy

A.3 Memorandum: Addition
of Chapter X to Enforcement
Management System

A.4 Enforcement Management
System–Chapter X: Setting
Priorities for Addressing
Discharges from Separate
Sanitary Sewers

A.1 Consolidated Appropriations Act for Fiscal Year 2001 (P.L. 106-554)

December 15, 2000

CONGRESSIONAL RECORD—HOUSE

H12273

"(2) **STORMWATER BEST MANAGEMENT PRACTICES.**—The control of pollutants from municipal separate storm sewer systems for the purpose of demonstrating and determining controls that are cost-effective and that use innovative technologies in reducing such pollutants from stormwater discharges.

"(b) **ADMINISTRATION.**—The Administrator, in coordination with the States, shall provide municipalities participating in a pilot project under this section the ability to engage in innovative practices, including the ability to unify separate wet weather control efforts under a single permit.

"(c) **FUNDING.**—
 "(1) **IN GENERAL.**—There is authorized to be appropriated to carry out this section \$10,000,000 for fiscal year 2002, \$15,000,000 for fiscal year 2003, and \$20,000,000 for fiscal year 2004. Such funds shall remain available until expended.

"(2) **STORMWATER.**—The Administrator shall make available not less than 20 percent of amounts appropriated for a fiscal year pursuant to this subsection to carry out the purposes of subsection (a)(2).

"(3) **ADMINISTRATIVE EXPENSES.**—The Administrator may retain not to exceed 4 percent of any amounts appropriated for a fiscal year pursuant to this subsection for the reasonable and necessary costs of administering this section.

"(d) **REPORT TO CONGRESS.**—Not later than 5 years after the date of enactment of this section, the Administrator shall transmit to Congress a report on the results of the pilot projects conducted under this section and their possible application nationwide."

(c) **SEWER OVERFLOW CONTROL GRANTS.**—Title 11 of the Federal Water Pollution Control Act (33 U.S.C. 1342 et seq.) is amended by adding at the end the following:

"SEC. 221. SEWER OVERFLOW CONTROL GRANTS.

"(a) **IN GENERAL.**—In any fiscal year in which the Administrator has available for obligation at least \$1,350,000,000 for the purposes of section 601—

"(1) the Administrator may make grants to States for the purpose of providing grants to a municipality or municipal entity for planning, design, and construction of treatment works to intercept, transport, control, or treat municipal combined sewer overflows and sanitary sewer overflows; and

"(2) subject to subsection (g), the Administrator may make a direct grant to a municipality or municipal entity for the purposes described in paragraph (1).

"(b) **PRIORITIZATION.**—In selecting from among municipalities applying for grants under subsection (a), a State or the Administrator shall give priority to an applicant that—

"(1) is a municipality that is a financially distressed community under subsection (c);

"(2) has implemented or is complying with an implementation schedule for the 9 minimum controls specified in the CSO control policy referred to in section 402(q)(1) and has begun implementing a long-term municipal combined sewer overflow control plan or a separate sanitary sewer overflow control plan; or

"(3) is requesting a grant for a project that is on a State's intended use plan pursuant to section 606(c); or

"(4) is an Alaska Native Village.

"(c) **FINANCIALLY DISTRESSED COMMUNITY.**—

"(1) **DEFINITION.**—In subsection (b), the term 'financially distressed community' means a community that meets affordability criteria established by the State in which the community is located, if such criteria are developed after public review and comment.

"(2) **CONSIDERATION OF IMPACT ON WATER AND SEWER RATES.**—In determining if a community is a distressed community for the purposes of subsection (b), the State shall consider, among other factors, the extent to which the rate of growth of a community's tax base has been historically slow such that implementing a plan de-

scribed in subsection (b)(2) would result in a significant increase in any water or sewer rate charged by the community's publicly owned wastewater treatment facility.

"(3) **INFORMATION TO ASSIST STATES.**—The Administrator may publish information to assist States in establishing affordability criteria under paragraph (1).

"(d) **COST SHARING.**—The Federal share of the cost of activities carried out using amounts from a grant made under subsection (a) shall be not less than 55 percent of the cost. The non-Federal share of the cost may include, in any amount, public and private funds and in-kind services, and may include, notwithstanding section 603(h), financial assistance, including loans, from a State water pollution control revolving fund.

"(e) **ADMINISTRATIVE REPORTING REQUIREMENTS.**—If a project receives grant assistance under subsection (a) and loan assistance from a State water pollution control revolving fund and the loan assistance is for 15 percent or more of the cost of the project, the project may be administered in accordance with State water pollution control revolving fund administrative reporting requirements for the purposes of streamlining such requirements.

"(f) **AUTHORIZATION OF APPROPRIATIONS.**—There is authorized to be appropriated to carry out this section \$750,000,000 for each of fiscal years 2002 and 2003. Such sums shall remain available until expended.

"(g) **ALLOCATION OF FUNDS.**—

"(1) **FISCAL YEAR 2002.**—Subject to subsection (h), the Administrator shall use the amounts appropriated to carry out this section for fiscal year 2002 for making grants to municipalities and municipal entities under subsection (a)(2), in accordance with the criteria set forth in subsection (b).

"(2) **FISCAL YEAR 2003.**—Subject to subsection (h), the Administrator shall use the amounts appropriated to carry out this section for fiscal year 2003 as follows:

"(A) Not to exceed \$250,000,000 for making grants to municipalities and municipal entities under subsection (a)(2), in accordance with the criteria set forth in subsection (b).

"(B) All remaining amounts for making grants to States under subsection (a)(1), in accordance with a formula to be established by the Administrator, after providing notice and an opportunity for public comment, that allocates to each State a proportional share of such amounts based on the total needs of the State for municipal combined sewer overflow controls and sanitary sewer overflow controls identified in the most recent survey conducted pursuant to section 516(b)(1).

"(h) **ADMINISTRATIVE EXPENSES.**—Of the amounts appropriated to carry out this section for each fiscal year—

"(1) the Administrator may retain an amount not to exceed 1 percent for the reasonable and necessary costs of administering this section; and

"(2) the Administrator, or a State, may retain an amount not to exceed 4 percent of any grant made to a municipality or municipal entity under subsection (a), for the reasonable and necessary costs of administering the grant.

"(i) **REPORTS.**—Not later than December 31, 2003, and periodically thereafter, the Administrator shall transmit to Congress a report containing recommended funding levels for grants under this section. The recommended funding levels shall be sufficient to ensure the continued expeditious implementation of municipal combined sewer overflow and sanitary sewer overflow controls nationwide."

(d) **INFORMATION ON CSOS AND SSOS.**—

(1) **REPORT TO CONGRESS.**—Not later than 3 years after the date of enactment of this Act, the Administrator of the Environmental Protection Agency shall transmit to Congress a report summarizing—

SEC. 112. WET WEATHER WATER QUALITY. (a) COMBINED SEWER OVERFLOWS.—Section 402 of the Federal Water Pollution Control Act (33 U.S.C. 1342) is amended by adding at the end the following:

"(g) **COMBINED SEWER OVERFLOWS.**—
 "(1) **REQUIREMENT FOR PERMITS, ORDERS, AND DECREES.**—Each permit, order, or decree issued pursuant to this Act after the date of enactment of this subsection for a discharge from a municipal combined storm and sanitary sewer shall conform to the Combined Sewer Overflow Control Policy signed by the Administrator on April 11, 1994 (in this subsection referred to as the 'CSO control policy').

"(2) **WATER QUALITY AND DESIGNATED USE REVIEW GUIDANCE.**—Not later than July 31, 2001, and after providing notice and opportunity for public comment, the Administrator shall issue guidance to facilitate the conduct of water quality and designated use reviews for municipal combined sewer overflow receiving waters.

"(3) **REPORT.**—Not later than September 1, 2001, the Administrator shall transmit to Congress a report on the progress made by the Environmental Protection Agency, States, and municipalities in implementing and enforcing the CSO control policy."

(b) **WET WEATHER PILOT PROGRAM.**—Title 1 of the Federal Water Pollution Control Act (33 U.S.C. 1251 et seq.) is amended by adding at the end the following:

"SEC. 121. WET WEATHER WATERSHED PILOT PROJECTS.

"(a) **IN GENERAL.**—The Administrator, in coordination with the States, may provide technical assistance and grants for treatment works to carry out pilot projects relating to the following areas of wet weather discharge control:

"(1) **WATERSHED MANAGEMENT OF WET WEATHER DISCHARGES.**—The management of municipal combined sewer overflows, sanitary sewer overflows, and stormwater discharges, on an integrated watershed or subwatershed basis for the purpose of demonstrating the effectiveness of a unified wet weather approach.

H12274

CONGRESSIONAL RECORD—HOUSE

December 15, 2000

(A) the extent of the human health and environmental impacts caused by municipal combined sewer overflows and sanitary sewer overflows, including the location of discharges causing such impacts, the volume of pollutants discharged, and the constituents discharged;

(B) the resources spent by municipalities to address these impacts; and

(C) an evaluation of the technologies used by municipalities to address these impacts.

(2) TECHNOLOGY CLEARINGHOUSE.—After transmitting a report under paragraph (1), the Administrator shall maintain a clearinghouse of cost-effective and efficient technologies for addressing human health and environmental impacts due to municipal combined sewer overflows and sanitary sewer overflows.

A.2 Combined Sewer Overflow (CSO) Control Policy

18688

Federal Register / Vol. 59, No. 75 / Tuesday, April 19, 1994 / Notices

ENVIRONMENTAL PROTECTION AGENCY

[FRL-4732-7]

Combined Sewer Overflow (CSO) Control Policy**AGENCY:** Environmental Protection Agency (EPA).**ACTION:** Final policy.

SUMMARY: EPA has issued a national policy statement entitled "Combined Sewer Overflow (CSO) Control Policy." This policy establishes a consistent national approach for controlling discharges from CSOs to the Nation's waters through the National Pollutant Discharge Elimination System (NPDES) permit program.

FOR FURTHER INFORMATION CONTACT: Jeffrey Lape, Office of Wastewater Enforcement and Compliance, MC-4201, U.S. Environmental Protection Agency, 401 M Street SW., Washington, DC 20460, (202) 260-7361.

SUPPLEMENTARY INFORMATION: The main purposes of the CSO Control Policy are to elaborate on the Environmental Protection Agency's (EPA's) National CSO Control Strategy published on September 8, 1989, at 54 FR 37370, and to expedite compliance with the requirements of the Clean Water Act (CWA). While implementation of the 1989 Strategy has resulted in progress toward controlling CSOs, significant public health and water quality risks remain.

This Policy provides guidance to permittees with CSOs, NPDES authorities and State water quality standards authorities on coordinating the planning, selection, and implementation of CSO controls that meet the requirements of the CWA and allow for public involvement during the decision-making process.

Contained in the Policy are provisions for developing appropriate, site-specific NPDES permit requirements for all combined sewer systems (CSS) that overflow as a result of wet weather events. For example, the Policy lays out two alternative approaches—the "demonstration" and the "presumption" approaches—that provide communities with targets for CSO controls that achieve compliance with the Act, particularly protection of water quality and designated uses. The Policy also includes enforcement initiatives to require the immediate elimination of overflows that occur during dry weather and to ensure that the remaining CWA requirements are complied with as soon as practicable.

The permitting provisions of the Policy were developed as a result of

extensive input received from key stakeholders during a negotiated policy dialogue. The CSO stakeholders included representatives from States, environmental groups, municipal organizations and others. The negotiated dialogue was conducted during the Summer of 1992 by the Office of Water and the Office of Water's Management Advisory Group. The enforcement initiatives, including one which is underway to address CSOs during dry weather, were developed by EPA's Office of Water and Office of Enforcement.

EPA issued a Notice of Availability on the draft CSO Control Policy on January 19, 1993, (58 FR 4994) and requested comments on the draft Policy by March 22, 1993. Approximately forty-one sets of written comments were submitted by a variety of interest groups including cities and municipal groups, environmental groups, States, professional organizations and others. All comments were considered as EPA prepared the Final Policy. The public comments were largely supportive of the draft Policy. EPA received broad endorsement of and support for the key principles and provisions from most commenters. Thus, this final Policy does not include significant changes to the major provisions of the draft Policy, but rather, it includes clarification and better explanation of the elements of the Policy to address several of the questions that were raised in the comments. Persons wishing to obtain copies of the public comments or EPA's summary analysis of the comments may write or call the EPA contact person.

The CSO Policy represents a comprehensive national strategy to ensure that municipalities, permitting authorities, water quality standards authorities and the public engage in a comprehensive and coordinated planning effort to achieve cost effective CSO controls that ultimately meet appropriate health and environmental objectives. The Policy recognizes the site-specific nature of CSOs and their impacts and provides the necessary flexibility to tailor controls to local situations. Major elements of the Policy ensure that CSO controls are cost effective and meet the objectives and requirements of the CWA.

The major provisions of the Policy are as follows.

CSO permittees should immediately undertake a process to accurately characterize their CSS and CSO discharges, demonstrate implementation of minimum technology-based controls identified in the Policy, and develop long-term CSO control plans which evaluate alternatives for attaining

compliance with the CWA, including compliance with water quality standards and protection of designated uses. Once the long-term CSO control plans are completed, permittees will be responsible to implement the plans' recommendations as soon as practicable.

State water quality standards authorities will be involved in the long-term CSO control planning effort as well. The water quality standards authorities will help ensure that development of the CSO permittees' long-term CSO control plans are coordinated with the review and possible revision of water quality standards on CSO-impacted waters.

NPDES authorities will issue/reissue or modify permits, as appropriate, to require compliance with the technology-based and water quality-based requirements of the CWA. After completion of the long-term CSO control plan, NPDES permits will be reissued or modified to incorporate the additional requirements specified in the Policy, such as performance standards for the selected controls based on average design conditions, a post-construction water quality assessment program, monitoring for compliance with water quality standards, and a reopener clause authorizing the NPDES authority to reopen and modify the permit if it is determined that the CSO controls fail to meet water quality standards or protect designated uses. NPDES authorities should commence enforcement actions against permittees that have CWA violations due to CSO discharges during dry weather. In addition, NPDES authorities should ensure the implementation of the minimum technology-based controls and incorporate a schedule into an appropriate enforceable mechanism, with appropriate milestone dates, to implement the required long-term CSO control plan. Schedules for implementation of the long-term CSO control plan may be phased based on the relative importance of adverse impacts upon water quality standards and designated uses, and on a permittee's financial capability.

EPA is developing extensive guidance to support the Policy and will announce the availability of the guidances and other outreach efforts through various means, as they become available. For example, EPA is preparing guidance on the nine minimum controls, characterization and monitoring of CSOs, development of long-term CSO control plans, and financial capability.

Permittees will be expected to comply with any existing CSO-related requirements in NPDES permits,

consent decrees or court orders unless revised to be consistent with this Policy.

The policy is organized as follows:

- I. Introduction
 - A. Purpose and Principles
 - B. Application of Policy
 - C. Effect on Current CSO Control Efforts
 - D. Small System Considerations
 - E. Implementation Responsibilities
 - F. Policy Development
- II. EPA Objectives for Permittees
 - A. Overview
 - B. Implementation of the Nine Minimum Controls
 - C. Long-Term CSO Control Plan
 - 1. Characterization, Monitoring, and Modeling of the Combined Sewer Systems
 - 2. Public Participation
 - 3. Consideration of Sensitive Areas
 - 4. Evaluation of Alternatives
 - 5. Cost/Performance Consideration
 - 6. Operational Plan
 - 7. Maximizing Treatment at the Existing POTW Treatment Plant
 - 8. Implementation Schedule
 - 9. Post-Construction Compliance Monitoring Program
- III. Coordination With State Water Quality Standards
 - A. Overview
 - B. Water Quality Standards Reviews
- IV. Expectations for Permitting Authorities
 - A. Overview
 - B. NPDES Permit Requirements
 - 1. Phase I Permits—Requirements for Demonstration of the Nine Minimum Controls and Development of the Long-Term CSO Control Plan
 - 2. Phase II Permits—Requirements for Implementation of a Long-Term CSO Control Plan
 - 3. Phasing Considerations
- V. Enforcement and Compliance
 - A. Overview
 - B. Enforcement of CSO Dry Weather Discharge Prohibition
 - C. Enforcement of Wet Weather CSO Requirements
 - 1. Enforcement for Compliance With Phase I Permits
 - 2. Enforcement for Compliance With Phase II Permits
 - D. Penalties

List of Subjects in 40 CFR Part 122

Water pollution control.

Authority: Clean Water Act, 33 U.S.C. 1251 *et seq.*

Dated: April 8, 1994.

Carol M. Browner,
Administrator.

Combined Sewer Overflow (CSO) Control Policy

I. Introduction

A. Purpose and Principles

The main purposes of this Policy are to elaborate on EPA's National Combined Sewer Overflow (CSO) Control Strategy published on September 8, 1989 at 54 FR 37370 (1989

Strategy) and to expedite compliance with the requirements of the Clean Water Act (CWA). While implementation of the 1989 Strategy has resulted in progress toward controlling CSOs, significant water quality risks remain.

A combined sewer system (CSS) is a wastewater collection system owned by a State or municipality (as defined by section 502(4) of the CWA) which conveys sanitary wastewaters (domestic, commercial and industrial wastewaters) and storm water through a single-pipe system to a Publicly Owned Treatment Works (POTW) Treatment Plant (as defined in 40 CFR 403.3(p)). A CSO is the discharge from a CSS at a point prior to the POTW Treatment Plant. CSOs are point sources subject to NPDES permit requirements including both technology-based and water quality-based requirements of the CWA. CSOs are not subject to secondary treatment requirements applicable to POTWs.

CSOs consist of mixtures of domestic sewage, industrial and commercial wastewaters, and storm water runoff. CSOs often contain high levels of suspended solids, pathogenic microorganisms, toxic pollutants, floatables, nutrients, oxygen-demanding organic compounds, oil and grease, and other pollutants. CSOs can cause exceedances of water quality standards (WQS). Such exceedances may pose risks to human health, threaten aquatic life and its habitat, and impair the use and enjoyment of the Nation's waterways.

This Policy is intended to provide guidance to permittees with CSOs, National Pollutant Discharge Elimination System (NPDES) permitting authorities, State water quality standards authorities and enforcement authorities. The purpose of the Policy is to coordinate the planning, selection, design and implementation of CSO management practices and controls to meet the requirements of the CWA and to involve the public fully during the decision making process.

This Policy reiterates the objectives of the 1989 Strategy:

1. To ensure that if CSOs occur, they are only as a result of wet weather;
2. To bring all wet weather CSO discharge points into compliance with the technology-based and water quality-based requirements of the CWA; and
3. To minimize water quality, aquatic biota, and human health impacts from CSOs.

This CSO Control Policy represents a comprehensive national strategy to ensure that municipalities, permitting

authorities, water quality standards authorities and the public engage in a comprehensive and coordinated planning effort to achieve cost-effective CSO controls that ultimately meet appropriate health and environmental objectives and requirements. The Policy recognizes the site-specific nature of CSOs and their impacts and provides the necessary flexibility to tailor controls to local situations. Four key principles of the Policy ensure that CSO controls are cost-effective and meet the objectives of the CWA. The key principles are:

1. Providing clear levels of control that would be presumed to meet appropriate health and environmental objectives;
2. Providing sufficient flexibility to municipalities, especially financially disadvantaged communities, to consider the site-specific nature of CSOs and to determine the most cost-effective means of reducing pollutants and meeting CWA objectives and requirements;
3. Allowing a phased approach to implementation of CSO controls considering a community's financial capability; and
4. Review and revision, as appropriate, of water quality standards and their implementation procedures when developing CSO control plans to reflect the site-specific wet weather impacts of CSOs.

This Policy is being issued in support of EPA's regulations and policy initiatives. This Policy is Agency guidance only and does not establish or affect legal rights or obligations. It does not establish a binding norm and is not finally determinative of the issues addressed. Agency decisions in any particular case will be made by applying the law and regulations on the basis of specific facts when permits are issued. The Administration has recommended that the 1994 amendments to the CWA endorse this final Policy.

B. Application of Policy

The permitting provisions of this Policy apply to all CSSs that overflow as a result of storm water flow, including snow melt runoff (40 CFR 122.26(b)(13)). Discharges from CSSs during dry weather are prohibited by the CWA. Accordingly, the permitting provisions of this Policy do not apply to CSOs during dry weather. Dry weather flow is the flow in a combined sewer that results from domestic sewage, groundwater infiltration, commercial and industrial wastewaters, and any other non-precipitation related flows (e.g., tidal infiltration). In addition to

the permitting provisions, the Enforcement and Compliance section of this Policy describes an enforcement initiative being developed for overflows that occur during dry weather.

Consistent with the 1989 Strategy, 30 States that submitted CSO permitting strategies have received EPA approval or, in the case of one State, conditional approval of its strategy. States and EPA Regional Offices should review these strategies and negotiate appropriate revisions to them to implement this Policy. Permitting authorities are encouraged to evaluate water pollution control needs on a watershed management basis and coordinate CSO control efforts with other point and nonpoint source control activities.

C. Effect on Current CSO Control Efforts

EPA recognizes that extensive work has been done by many Regions, States, and municipalities to abate CSOs. As such, portions of this Policy may already have been addressed by permittees' previous efforts to control CSOs. Therefore, portions of this Policy may not apply, as determined by the permitting authority on a case-by-case basis, under the following circumstances:

1. Any permittee that, on the date of publication of this final Policy, has completed or substantially completed construction of CSO control facilities that are designed to meet WQS and protect designated uses, and where it has been determined that WQS are being or will be attained, is not covered by the initial planning and construction provisions in this Policy; however, the operational plan and post-construction monitoring provisions continue to apply. If, after monitoring, it is determined that WQS are not being attained, the permittee should be required to submit a revised CSO control plan that, once implemented, will attain WQS.

2. Any permittee that, on the date of publication of this final Policy, has substantially developed or is implementing a CSO control program pursuant to an existing permit or enforcement order, and such program is considered by the NPDES permitting authority to be adequate to meet WQS and protect designated uses and is reasonably equivalent to the treatment objectives of this Policy, should complete those facilities without further planning activities otherwise expected by this Policy. Such programs, however, should be reviewed and modified to be consistent with the sensitive area, financial capability, and post-construction monitoring provisions of this Policy.

3. Any permittee that has previously constructed CSO control facilities in an effort to comply with WQS but has failed to meet such applicable standards or to protect designated uses due to remaining CSOs may receive consideration for such efforts in future permits or enforceable orders for long-term CSO control planning, design and implementation.

In the case of any ongoing or substantially completed CSO control effort, the NPDES permit or other enforceable mechanism, as appropriate, should be revised to include all appropriate permit requirements consistent with Section IV.B. of this Policy.

D. Small System Considerations

The scope of the long-term CSO control plan, including the characterization, monitoring and modeling, and evaluation of alternatives portions of this Policy may be difficult for some small CSSs. At the discretion of the NPDES Authority, jurisdictions with populations under 75,000 may not need to complete each of the formal steps outlined in Section II.C. of this Policy, but should be required through their permits or other enforceable mechanisms to comply with the nine minimum controls (II.B), public participation (II.C.2), and sensitive areas (II.C.3) portions of this Policy. In addition, the permittee may propose to implement any of the criteria contained in this Policy for evaluation of alternatives described in II.C.4. Following approval of the proposed plan, such jurisdictions should construct the control projects and propose a monitoring program sufficient to determine whether WQS are attained and designated uses are protected.

In developing long-term CSO control plans based on the small system considerations discussed in the preceding paragraph, permittees are encouraged to discuss the scope of their long-term CSO control plan with the WQS authority and the NPDES authority. These discussions will ensure that the plan includes sufficient information to enable the permitting authority to identify the appropriate CSO controls.

E. Implementation Responsibilities

NPDES authorities (authorized States or EPA Regional Offices, as appropriate) are responsible for implementing this Policy. It is their responsibility to assure that CSO permittees develop long-term CSO control plans and that NPDES permits meet the requirements of the CWA. Further, they are responsible for coordinating the review of the long-term

CSO control plan and the development of the permit with the WQS authority to determine if revisions to the WQS are appropriate. In addition, they should determine the appropriate vehicle (i.e., permit reissuance, information request under CWA section 308 or State equivalent or enforcement action) to ensure that compliance with the CWA is achieved as soon as practicable.

Permittees are responsible for documenting the implementation of the nine minimum controls and developing and implementing a long-term CSO control plan, as described in this Policy. EPA recognizes that financial considerations are a major factor affecting the implementation of CSO controls. For that reason, this Policy allows consideration of a permittee's financial capability in connection with the long-term CSO control planning effort, WQS review, and negotiation of enforceable schedules. However, each permittee is ultimately responsible for aggressively pursuing financial arrangements for the implementation of its long-term CSO control plan. As part of this effort, communities should apply to their State Revolving Fund program, or other assistance programs as appropriate, for financial assistance.

EPA and the States will undertake action to assure that all permittees with CSSs are subject to a consistent review in the permit development process, have permit requirements that achieve compliance with the CWA, and are subject to enforceable schedules that require the earliest practicable compliance date considering physical and financial feasibility.

F. Policy Development

This Policy devotes a separate section to each step involved in developing and implementing CSO controls. This is not to imply that each function occurs separately. Rather, the entire process surrounding CSO controls, community planning, WQS and permit development/revision, enforcement/compliance actions and public participation must be coordinated to control CSOs effectively. Permittees and permitting authorities are encouraged to consider innovative and alternative approaches and technologies that achieve the objectives of this Policy and the CWA.

In developing this Policy, EPA has included information on what responsible parties are expected to accomplish. Subsequent documents will provide additional guidance on how the objectives of this Policy should be met. These documents will provide further guidance on: CSO permit writing, the nine minimum controls, long-term CSO

control plans, financial capability, sewer system characterization and receiving water monitoring and modeling, and application of WQS to CSO-impacted waters. For most CSO control efforts however, sufficient detail has been included in this Policy to begin immediate implementation of its provisions.

II. EPA Objectives for Permittees

A. Overview

Permittees with CSSs that have CSOs should immediately undertake a process to accurately characterize their sewer systems, to demonstrate implementation of the nine minimum controls, and to develop a long-term CSO control plan.

B. Implementation of the Nine Minimum Controls

Permittees with CSOs should submit appropriate documentation demonstrating implementation of the nine minimum controls, including any proposed schedules for completing minor construction activities. The nine minimum controls are:

1. Proper operation and regular maintenance programs for the sewer system and the CSOs;
2. Maximum use of the collection system for storage;
3. Review and modification of pretreatment requirements to assure CSO impacts are minimized;
4. Maximization of flow to the POTW for treatment;
5. Prohibition of CSOs during dry weather;
6. Control of solid and floatable materials in CSOs;
7. Pollution prevention;
8. Public notification to ensure that the public receives adequate notification of CSO occurrences and CSO impacts; and
9. Monitoring to effectively characterize CSO impacts and the efficacy of CSO controls.

Selection and implementation of actual control measures should be based on site-specific considerations including the specific CSS's characteristics discussed under the sewer system characterization and monitoring portions of this Policy. Documentation of the nine minimum controls may include operation and maintenance plans, revised sewer use ordinances for industrial users, sewer system inspection reports, infiltration/inflow studies, pollution prevention programs, public notification plans, and facility plans for maximizing the capacities of the existing collection, storage and treatment systems, as well as contracts and schedules for minor construction

programs for improving the existing system's operation. The permittee should also submit any information or data on the degree to which the nine minimum controls achieve compliance with water quality standards. These data and information should include results made available through monitoring and modeling activities done in conjunction with the development of the long-term CSO control plan described in this Policy.

This documentation should be submitted as soon as practicable, but no later than two years after the requirement to submit such documentation is included in an NPDES permit or other enforceable mechanism. Implementation of the nine minimum controls with appropriate documentation should be completed as soon as practicable but no later than January 1, 1997. These dates should be included in an appropriate enforceable mechanism.

Because the CWA requires immediate compliance with technology-based controls (section 301(b)), which on a Best Professional Judgment basis should include the nine minimum controls, a compliance schedule for implementing the nine minimum controls, if necessary, should be included in an appropriate enforceable mechanism.

C. Long-Term CSO Control Plan

Permittees with CSOs are responsible for developing and implementing long-term CSO control plans that will ultimately result in compliance with the requirements of the CWA. The long-term plans should consider the site-specific nature of CSOs and evaluate the cost effectiveness of a range of control options/strategies. The development of the long-term CSO control plan and its subsequent implementation should also be coordinated with the NPDES authority and the State authority responsible for reviewing and revising the State's WQS. The selected controls should be designed to allow cost effective expansion or cost effective retrofitting if additional controls are subsequently determined to be necessary to meet WQS, including existing and designated uses.

This policy identifies EPA's major objectives for the long-term CSO control plan. Permittees should develop and submit this long-term CSO control plan as soon as practicable, but generally within two years after the date of the NPDES permit provision, Section 308 information request, or enforcement action requiring the permittee to develop the plan. NPDES authorities may establish a longer timetable for completion of the long-term CSO

control plan on a case-by-case basis to account for site-specific factors which may influence the complexity of the planning process. Once agreed upon, these dates should be included in an appropriate enforceable mechanism.

EPA expects each long-term CSO control plan to utilize appropriate information to address the following minimum elements. The Plan should also include both fixed-date project implementation schedules (which may be phased) and a financing plan to design and construct the project as soon as practicable. The minimum elements of the long-term CSO control plan are described below.

1. Characterization, Monitoring, and Modeling of the Combined Sewer System

In order to design a CSO control plan adequate to meet the requirements of the CWA, a permittee should have a thorough understanding of its sewer system, the response of the system to various precipitation events, the characteristics of the overflows, and the water quality impacts that result from CSOs. The permittee should adequately characterize through monitoring, modeling, and other means as appropriate, for a range of storm events, the response of its sewer system to wet weather events including the number, location and frequency of CSOs, volume, concentration and mass of pollutants discharged and the impacts of the CSOs on the receiving waters and their designated uses. The permittee may need to consider information on the contribution and importance of other pollution sources in order to develop a final plan designed to meet water quality standards. The purpose of the system characterization, monitoring and modeling program initially is to assist the permittee in developing appropriate measures to implement the nine minimum controls and, if necessary, to support development of the long-term CSO control plan. The monitoring and modeling data also will be used to evaluate the expected effectiveness of both the nine minimum controls and, if necessary, the long-term CSO controls, to meet WQS.

The major elements of a sewer system characterization are described below.

a. **Rainfall Records**—The permittee should examine the complete rainfall record for the geographic area of its existing CSS using sound statistical procedures and best available data. The permittee should evaluate flow variations in the receiving water body to correlate between CSOs and receiving water conditions.

b. **Combined Sewer System Characterization**—The permittee should evaluate the nature and extent of its sewer system through evaluation of available sewer system records, field inspections and other activities necessary to understand the number, location and frequency of overflows and their location relative to sensitive areas and to pollution sources in the collection system, such as indirect significant industrial users.

c. **CSO Monitoring**—The permittee should develop a comprehensive, representative monitoring program that measures the frequency, duration, flow rate, volume and pollutant concentration of CSO discharges and assesses the impact of the CSOs on the receiving waters. The monitoring program should include necessary CSO effluent and ambient in-stream monitoring and, where appropriate, other monitoring protocols such as biological assessment, toxicity testing and sediment sampling. Monitoring parameters should include, for example, oxygen demanding pollutants, nutrients, toxic pollutants, sediment contaminants, pathogens, bacteriological indicators (e.g., *Enterococcus*, *E. Coli*), and toxicity. A representative sample of overflow points can be selected that is sufficient to allow characterization of CSO discharges and their water quality impacts and to facilitate evaluation of control plan alternatives.

d. **Modeling**—Modeling of a sewer system is recognized as a valuable tool for predicting sewer system response to various wet weather events and assessing water quality impacts when evaluating different control strategies and alternatives. EPA supports the proper and effective use of models, where appropriate, in the evaluation of the nine minimum controls and the development of the long-term CSO control plan. It is also recognized that there are many models which may be used to do this. These models range from simple to complex. Having decided to use a model, the permittee should base its choice of a model on the characteristics of its sewer system, the number and location of overflow points, and the sensitivity of the receiving water body to the CSO discharges. Use of models should include appropriate calibration and verification with field measurements. The sophistication of the model should relate to the complexity of the system to be modeled and to the information needs associated with evaluation of CSO control options and water quality impacts. EPA believes that continuous simulation models, using historical rainfall data, may be the best

way to model sewer systems, CSOs, and their impacts. Because of the iterative nature of modeling sewer systems, CSOs, and their impacts, monitoring and modeling efforts are complementary and should be coordinated.

2. Public Participation

In developing its long-term CSO control plan, the permittee will employ a public participation process that actively involves the affected public in the decision-making to select the long-term CSO controls. The affected public includes rate payers, industrial users of the sewer system, persons who reside downstream from the CSOs, persons who use and enjoy these downstream waters, and any other interested persons.

3. Consideration of Sensitive Areas

EPA expects a permittee's long-term CSO control plan to give the highest priority to controlling overflows to sensitive areas. Sensitive areas, as determined by the NPDES authority in coordination with State and Federal agencies, as appropriate, include designated Outstanding National Resource Waters, National Marine Sanctuaries, waters with threatened or endangered species and their habitat, waters with primary contact recreation, public drinking water intakes or their designated protection areas, and shellfish beds. For such areas, the long-term CSO control plan should:

- a. Prohibit new or significantly increased overflows;
 - b. i. Eliminate or relocate overflows that discharge to sensitive areas wherever physically possible and economically achievable, except where elimination or relocation would provide less environmental protection than additional treatment; or
 - ii. Where elimination or relocation is not physically possible and economically achievable, or would provide less environmental protection than additional treatment, provide the level of treatment for remaining overflows deemed necessary to meet WQS for full protection of existing and designated uses. In any event, the level of control should not be less than those described in Evaluation of Alternatives below; and
 - c. Where elimination or relocation has been proven not to be physically possible and economically achievable, permitting authorities should require, for each subsequent permit term, a reassessment based on new or improved techniques to eliminate or relocate, or on changed circumstances that influence economic achievability.

4. Evaluation of Alternatives

EPA expects the long-term CSO control plan to consider a reasonable range of alternatives. The plan should, for example, evaluate controls that would be necessary to achieve zero overflow events per year, an average of one to three, four to seven, and eight to twelve overflow events per year. Alternatively, the long-term plan could evaluate controls that achieve 100% capture, 90% capture, 85% capture, 80% capture, and 75% capture for treatment. The long-term control plan should also consider expansion of POTW secondary and primary capacity in the CSO abatement alternative analysis. The analysis of alternatives should be sufficient to make a reasonable assessment of cost and performance as described in Section I.C.5. Because the final long-term CSO control plan will become the basis for NPDES permit limits and requirements, the selected controls should be sufficient to meet CWA requirements.

In addition to considering sensitive areas, the long-term CSO control plan should adopt one of the following approaches:

a. "Presumption" Approach

A program that meets any of the criteria listed below would be presumed to provide an adequate level of control to meet the water quality-based requirements of the CWA, provided the permitting authority determines that such presumption is reasonable in light of the data and analysis conducted in the characterization, monitoring, and modeling of the system and the consideration of sensitive areas described above. These criteria are provided because data and modeling of wet weather events often do not give a clear picture of the level of CSO controls necessary to protect WQS.

- i. No more than an average of four overflow events per year, provided that the permitting authority may allow up to two additional overflow events per year. For the purpose of this criterion, an overflow event is one or more overflows from a CSS as the result of a precipitation event that does not receive the minimum treatment specified below; or
- ii. The elimination or the capture for treatment of no less than 85% by volume of the combined sewage collected in the CSS during precipitation events on a system-wide annual average basis; or
- iii. The elimination or removal of no less than the mass of the pollutants, identified as causing water quality impairment through the sewer system

characterization, monitoring, and modeling effort, for the volumes that would be eliminated or captured for treatment under paragraph ii. above. Combined sewer flows remaining after implementation of the nine minimum controls and within the criteria specified at II.C.4.a.i or ii, should receive a minimum of:

- Primary clarification (Removal of floatables and settleable solids may be achieved by any combination of treatment technologies or methods that are shown to be equivalent to primary clarification.);
- Solids and floatables disposal; and
- Disinfection of effluent, if

necessary, to meet WQS, protect designated uses and protect human health, including removal of harmful disinfection chemical residuals, where necessary.

b. "Demonstration" Approach

A permittee may demonstrate that a selected control program, though not meeting the criteria specified in II.C.4.a. above is adequate to meet the water quality-based requirements of the CWA. To be a successful demonstration, the permittee should demonstrate each of the following:

- i. The planned control program is adequate to meet WQS and protect designated uses, unless WQS or uses cannot be met as a result of natural background conditions or pollution sources other than CSOs;

- ii. The CSO discharges remaining after implementation of the planned control program will not preclude the attainment of WQS or the receiving waters' designated uses or contribute to their impairment. Where WQS and designated uses are not met in part because of natural background conditions or pollution sources other than CSOs, a total maximum daily load, including a wasteload allocation and a load allocation, or other means should be used to apportion pollutant loads;

- iii. The planned control program will provide the maximum pollution reduction benefits reasonably attainable; and

- iv. The planned control program is designed to allow cost effective expansion or cost effective retrofitting if additional controls are subsequently determined to be necessary to meet WQS or designated uses.

5. Cost/Performance Considerations

The permittee should develop appropriate cost/performance curves to demonstrate the relationships among a comprehensive set of reasonable control alternatives that correspond to the different ranges specified in Section

II.C.4. This should include an analysis to determine where the increment of pollution reduction achieved in the receiving water diminishes compared to the increased costs. This analysis, often known as knee of the curve, should be among the considerations used to help guide selection of controls.

6. Operational Plan

After agreement between the permittee and NPDES authority on the necessary CSO controls to be implemented under the long-term CSO control plan, the permittee should revise the operation and maintenance program developed as part of the nine minimum controls to include the agreed-upon long-term CSO controls. The revised operation and maintenance program should maximize the removal of pollutants during and after each precipitation event using all available facilities within the collection and treatment system. For any flows in excess of the criteria specified at II.C.4.a.i., ii. or iii and not receiving the treatment specified in II.C.4.a. the operational plan should ensure that such flows receive treatment to the greatest extent practicable.

7. Maximizing Treatment at the Existing POTW Treatment Plant

In some communities, POTW treatment plants may have primary treatment capacity in excess of their secondary treatment capacity. One effective strategy to abate pollution resulting from CSOs is to maximize the delivery of flows during wet weather to the POTW treatment plant for treatment. Delivering these flows can have two significant water quality benefits: First, increased flows during wet weather to the POTW treatment plant may enable the permittee to eliminate or minimize overflows to sensitive areas; second, this would maximize the use of available POTW facilities for wet weather flows and would ensure that combined sewer flows receive at least primary treatment prior to discharge.

Under EPA regulations, the intentional diversion of waste streams from any portion of a treatment facility, including secondary treatment, is a bypass. EPA bypass regulations at 40 CFR 122.41(m) allow for a facility to bypass some or all the flow from its treatment process under specified limited circumstances. Under the regulation, the permittee must show that the bypass was unavoidable to prevent loss of life, personal injury or severe property damage, that there was no feasible alternative to the bypass and that the permittee submitted the required notices. In addition, the

regulation provides that a bypass may be approved only after consideration of adverse effects.

Normally, it is the responsibility of the permittee to document, on a case-by-case basis, compliance with 40 CFR 122.41(m) in order to bypass flows legally. For some CSO-related permits, the study of feasible alternatives in the control plan may provide sufficient support for the permit record and for approval of a CSO-related bypass in the permit itself, and to define the specific parameters under which a bypass can legally occur. For approval of a CSO-related bypass, the long-term CSO control plan, at a minimum, should provide justification for the cut-off point at which the flow will be diverted from the secondary treatment portion of the treatment plant, and provide a benefit-cost analysis demonstrating that conveyance of wet weather flow to the POTW for primary treatment is more beneficial than other CSO abatement alternatives such as storage and pump back for secondary treatment, sewer separation, or satellite treatment. Such a permit must define under what specific wet weather conditions a CSO-related bypass is allowed and also specify what treatment or what monitoring, and effluent limitations and requirements apply to the bypass flow. The permit should also provide that approval for the CSO-related bypass will be reviewed and may be modified or terminated if there is a substantial increase in the volume or character of pollutants being introduced to the POTW. The CSO-related bypass provision in the permit should also make it clear that all wet weather flows passing the headworks of the POTW treatment plant will receive at least primary clarification and solids and floatables removal and disposal, and disinfection, where necessary, and any other treatment that can reasonably be provided.

Under this approach, EPA would allow a permit to authorize a CSO-related bypass of the secondary treatment portion of the POTW treatment plant for combined sewer flows in certain identified circumstances. This provision would apply only to those situations where the POTW would ordinarily meet the requirements of 40 CFR 122.41(m) as evaluated on a case-by-case basis. Therefore, there must be sufficient data in the administrative record (reflected in the permit fact sheet or statement of basis) supporting all the requirements in 40 CFR 122.41(m)(4) for approval of an anticipated bypass.

For the purposes of applying this regulation to CSO permittees, "severe property damage" could include

situations where flows above a certain level wash out the POTW's secondary treatment system. EPA further believes that the feasible alternatives requirement of the regulation can be met if the record shows that the secondary treatment system is properly operated and maintained, that the system has been designed to meet secondary limits for flows greater than the peak dry weather flow, plus an appropriate quantity of wet weather flow, and that it is either technically or financially infeasible to provide secondary treatment at the existing facilities for greater amounts of wet weather flow. The feasible alternative analysis should include, for example, consideration of enhanced primary treatment (e.g., chemical addition) and non-biological secondary treatment. Other bases supporting a finding of no feasible alternative may also be available on a case-by-case basis. As part of its consideration of possible adverse effects resulting from the bypass, the permitting authority should also ensure that the bypass will not cause exceedances of WQS.

This Policy does not address the appropriateness of approving anticipated bypasses through NPDES permits in advance outside the CSO context.

8. Implementation Schedule

The permittee should include all pertinent information in the long term control plan necessary to develop the construction and financing schedule for implementation of CSO controls. Schedules for implementation of the CSO controls may be phased based on the relative importance of adverse impacts upon WQS and designated uses, priority projects identified in the long-term plan, and on a permittee's financial capability.

Construction phasing should consider:

- a. Eliminating overflows that discharge to sensitive areas as the highest priority;
- b. Use impairment;
- c. The permittee's financial capability including consideration of such factors as:
 - i. Median household income;
 - ii. Total annual wastewater and CSO control costs per household as a percent of median household income;
 - iii. Overall net debt as a percent of full market property value;
 - iv. Property tax revenues as a percent of full market property value;
 - v. Property tax collection rate;
 - vi. Unemployment; and
 - vii. Bond rating;
- d. Grant and loan availability;

e. Previous and current residential, commercial and industrial sewer user fees and rate structures; and

f. Other viable funding mechanisms and sources of financing.

9. Post-Construction Compliance Monitoring Program

The selected CSO controls should include a post-construction water quality monitoring program adequate to verify compliance with water quality standards and protection of designated uses as well as to ascertain the effectiveness of CSO controls. This water quality compliance monitoring program should include a plan to be approved by the NPDES authority that details the monitoring protocols to be followed, including the necessary effluent and ambient monitoring and, where appropriate, other monitoring protocols such as biological assessments, whole effluent toxicity testing, and sediment sampling.

III. Coordination With State Water Quality Standards

A. Overview

WQS are State adopted, or Federally promulgated rules which serve as the goals for the water body and the legal basis for the water quality-based NPDES permit requirements under the CWA. WQS consist of uses which States designate for their water bodies, criteria to protect the uses, an anti-degradation policy to protect the water quality improvements gained and other policies affecting the implementation of the standards. A primary objective of the long-term CSO control plan is to meet WQS, including the designated uses through reducing risks to human health and the environment by eliminating, relocating or controlling CSOs to the affected waters.

State WQS authorities, NPDES authorities, EPA regional offices, permittees, and the public should meet early and frequently throughout the long-term CSO control planning process. Development of the long-term plan should be coordinated with the review and appropriate revision of WQS and implementation procedures on CSO-impacted waters to ensure that the long-term controls will be sufficient to meet water quality standards. As part of these meetings, participants should agree on the data, information and analyses needed to support the development of the long-term CSO control plan and the review of applicable WQS, and implementation procedures, if appropriate. Agreements should be reached on the monitoring protocols and models that will be used

to evaluate the water quality impacts of the overflows, to analyze the attainability of the WQS and to determine the water quality-based requirements for the permit. Many opportunities exist for permittees and States to share information as control programs are developed and as WQS are reviewed. Such information should assist States in determining the need for revisions to WQS and implementation procedures to better reflect the site-specific wet weather impacts of CSOs. Coordinating the development of the long-term CSO control plan and the review of the WQS and implementation procedures provides greater assurance that the long-term control plan selected and the limits and requirements included in the NPDES permit will be sufficient to meet WQS and to comply with sections 301(b)(1)(C) and 402(a)(2) of the CWA.

EPA encourages States and permittees jointly to sponsor workshops for the affected public in the development of the long-term CSO control plan and during the development of appropriate revisions to WQS for CSO-impacted waters. Workshops provide a forum for including the public in discussions of the implications of the proposed long-term CSO control plan on the water quality and uses for the receiving water.

B. Water Quality Standards Reviews

The CWA requires States to periodically, but at least once every three years, hold public hearings for the purpose of reviewing applicable water quality standards and, as appropriate, modifying and adopting standards. States must provide the public an opportunity to comment on any proposed revision to water quality standards and all revisions must be submitted to EPA for review and approval.

EPA regulations and guidance provide States with the flexibility to adapt their WQS, and implementation procedures to reflect site-specific conditions including those related to CSOs. For example, a State may adopt site-specific criteria for a particular pollutant if the State determines that the site-specific criteria fully protects the designated use (40 CFR 131.11). In addition, the regulations at 40 CFR 131.10(g), (h), and (j) specify when and how a designated use may be modified. A State may remove a designated use from its water quality standards only if the designated use is not an existing use. An existing use is a use actually attained in the water body on or after November 28, 1975. Furthermore, a State may not remove a designated use that will be attained by implementing the

technology-based effluent limits required under sections 301(b) and 306 of the CWA and by implementing cost-effective and reasonable best management practices for nonpoint source controls. Thus, if a State has a reasonable basis to determine that the current designated use could be attained after implementation of the technology-based controls of the CWA, then the use could not be removed.

In determining whether a use is attainable and prior to removing a designated use, States must conduct and submit to EPA a use attainability analysis. A use attainability analysis is a structured scientific assessment of the factors affecting the use, including the physical, chemical, biological, and economic factors described in 40 CFR 131.10(g). As part of the analysis, States should evaluate whether the designated use could be attained if CSO controls were implemented. For example, States should examine if sediment loadings from CSOs could be reduced so as not to bury spawning beds, or if biochemical oxygen demanding material in the effluent or the toxicity of the effluent could be corrected so as to reduce the acute or chronic physiological stress on or bioaccumulation potential of aquatic organisms.

In reviewing the attainability of their WQS and the applicability of their implementation procedures to CSO-impacted waters, States are encouraged to define more explicitly their recreational and aquatic life uses and then, if appropriate, modify the criteria accordingly to protect the designated uses.

Another option is for States to adopt partial uses by defining when primary contact recreation such as swimming does not exist, such as during certain seasons of the year in northern climates or during a particular type of storm event. In making such adjustments to their uses, States must ensure that downstream uses are protected, and that during other seasons or after the storm event has passed, the use is fully protected.

In addition to defining recreational uses with greater specificity, States are also encouraged to define the aquatic uses more precisely. Rather than "aquatic life use protection," States should consider defining the type of fishery to be protected such as a cold water fishery (e.g., trout or salmon) or warm weather fishery (e.g., bluegill or large mouth bass). Explicitly defining the type of fishery to be protected may assist the permittee in enlisting the support of citizens for a CSO control plan.

A water quality standard variance may be appropriate, in limited circumstances on CSO-impacted waters, where the State is uncertain as to whether a standard can be attained and time is needed for the State to conduct additional analyses on the attainability of the standard. Variances are short-term modifications in water quality standards. Subject to EPA approval, States, with their own statutory authority, may grant a variance to a specific discharger for a specific pollutant. The justification for a variance is similar to that required for a permanent change in the standard, although the showings needed are less rigorous. Variances are also subject to public participation requirements of the water quality standards and permits programs and are reviewable generally every three years. A variance allows the CSO permit to be written to meet the "modified" water quality standard as analyses are conducted and as progress is made to improve water quality.

Justifications for variances are the same as those identified in 40 CFR 131.10(g) for modifications in uses. States must provide an opportunity for public review and comment on all variances. If States use the permit as the vehicle to grant the variance, notice of the permit must clearly state that the variance modifies the State's water quality standards. If the variance is approved, the State appends the variance to the State's standards and reviews the variance every three years.

IV. Expectations for Permitting Authorities

A. Overview

CSOs are point sources subject to NPDES permit requirements including both technology-based and water quality-based requirements of the CWA. CSOs are not subject to secondary treatment regulations applicable to publicly owned treatment works (*Montgomery Environmental Coalition vs. Costle*, 646 F.2d 568 (D.C. Cir. 1980)).

All permits for CSOs should require the nine minimum controls as a minimum best available technology economically achievable and best conventional technology (BAT/BCT) established on a best professional judgment (BPJ) basis by the permitting authority (40 CFR 125.3). Water quality-based requirements are to be established based on applicable water quality standards.

This policy establishes a uniform, nationally consistent approach to developing and issuing NPDES permits to permittees with CSOs. Permits for

CSOs should be developed and issued expeditiously. A single, system-wide permit generally should be issued for all discharges, including CSOs, from a CSS operated by a single authority. When different parts of a single CSS are operated by more than one authority, permits issued to each authority should generally require joint preparation and implementation of the elements of this Policy and should specifically define the responsibilities and duties of each authority. Permittees should be required to coordinate system-wide implementation of the nine minimum controls and the development and implementation of the long-term CSO control plan.

The individual authorities are responsible for their own discharges and should cooperate with the permittee for the POTW receiving the flows from the CSS. When a CSO is permitted separately from the POTW, both permits should be cross-referenced for informational purposes.

EPA Regions and States should review the CSO permitting priorities established in the State CSO Permitting Strategies developed in response to the 1989 Strategy. Regions and States may elect to revise these previous priorities. In setting permitting priorities, Regions and States should not just focus on those permittees that have initiated monitoring programs. When setting priorities, Regions and States should consider, for example, the known or potential impact of CSOs on sensitive areas, and the extent of upstream industrial user discharges to the CSS.

During the permittee's development of the long-term CSO control plan, the permit writer should promote coordination between the permittee and State WQS authority in connection with possible WQS revisions. Once the permittee has completed development of the long-term CSO control plan and has coordinated with the permitting authority the selection of the controls necessary to meet the requirements of the CWA, the permitting authority should include in an appropriate enforceable mechanism, requirements for implementation of the long-term CSO control plan, including conditions for water quality monitoring and operation and maintenance.

B. NPDES Permit Requirements

Following are the major elements of NPDES permits to implement this Policy and ensure protection of water quality.

1. Phase I Permits—Requirements for Demonstration of Implementation of the Nine Minimum Controls and Development of the Long-Term CSO Control Plan

In the Phase I permit issued/modified to reflect this Policy, the NPDES authority should at least require permittees to:

- a. Immediately implement BAT/BCT, which at a minimum includes the nine minimum controls, as determined on a BPJ basis by the permitting authority;
- b. Develop and submit a report documenting the implementation of the nine minimum controls within two years of permit issuance/modification;
- c. Comply with applicable WQS, no later than the date allowed under the State's WQS, expressed in the form of a narrative limitation; and
- d. develop and submit, consistent with this Policy and based on a schedule in an appropriate enforceable mechanism, a long-term CSO control plan as soon as practicable, but generally within two years after the effective date of the permit issuance/modification. However, permitting authorities may establish a longer timetable for completion of the long-term CSO control plan on a case-by-case basis to account for site-specific factors that may influence the complexity of the planning process.

The NPDES authority should include compliance dates on the fastest practicable schedule for each of the nine minimum controls in an appropriate enforceable mechanism issued in conjunction with the Phase I permit. The use of enforceable orders is necessary unless Congress amends the CWA. All orders should require compliance with the nine minimum controls no later than January 1, 1997.

2. Phase II Permits—Requirements for Implementation of a Long-Term CSO Control Plan

Once the permittee has completed development of the long-term CSO control plan and the selection of the controls necessary to meet CWA requirements has been coordinated with the permitting and WQS authorities, the permitting authority should include, in an appropriate enforceable mechanism, requirements for implementation of the long-term CSO control plan as soon as practicable. Where the permittee has selected controls based on the "presumption" approach described in Section II.C.4, the permitting authority must have determined that the presumption that such level of treatment will achieve water quality standards is reasonable in light of the

data and analysis conducted under this Policy. The Phase II permit should contain:

- a. Requirements to implement the technology-based controls including the nine minimum controls determined on a BPJ basis;
- b. Narrative requirements which insure that the selected CSO controls are implemented, operated and maintained as described in the long-term CSO control plan;
- c. Water quality-based effluent limits under 40 CFR 122.44(d)(1) and 122.44(k), requiring, at a minimum, compliance with, no later than the date allowed under the State's WQS, the numeric performance standards for the selected CSO controls, based on average design conditions specifying at least one of the following:
 - i. A maximum number of overflow events per year for specified design conditions consistent with II.C.4.a.i; or
 - ii. A minimum percentage capture of combined sewage by volume for treatment under specified design conditions consistent with II.C.4.a.ii; or
 - iii. A minimum removal of the mass of pollutants discharged for specified design conditions consistent with II.C.4.a.iii; or
 - iv. performance standards and requirements that are consistent with II.C.4.b. of the Policy.
- d. A requirement to implement, with an established schedule, the approved post-construction water quality assessment program including requirements to monitor and collect sufficient information to demonstrate compliance with WQS and protection of designated uses as well as to determine the effectiveness of CSO controls.
- e. A requirement to reassess overflows to sensitive areas in those cases where elimination or relocation of the overflows is not physically possible and economically achievable. The reassessment should be based on consideration of new or improved techniques to eliminate or relocate overflows or changed circumstances that influence economic achievability;
- f. Conditions establishing requirements for maximizing the treatment of wet weather flows at the POTW treatment plant, as appropriate, consistent with Section II.C.7. of this Policy;
- g. A reopener clause authorizing the NPDES authority to reopen and modify the permit upon determination that the CSO controls fail to meet WQS or protect designated uses. Upon such determination, the NPDES authority should promptly notify the permittee and proceed to modify or reissue the permit. The permittee should be

required to develop, submit and implement, as soon as practicable, a revised CSO control plan which contains additional controls to meet WQS and designated uses. If the initial CSO control plan was approved under the demonstration provision of Section II.C.4.b., the revised plan, at a minimum, should provide for controls that satisfy one of the criteria in Section II.C.4.a. unless the permittee demonstrates that the revised plan is clearly adequate to meet WQS at a lower cost and it is shown that the additional controls resulting from the criteria in Section II.C.4.a. will not result in a greater overall improvement in water quality.

Unless the permittee can comply with all of the requirements of the Phase II permit, the NPDES authority should include, in an enforceable mechanism, compliance dates on the fastest practicable schedule for those activities directly related to meeting the requirements of the CWA. For major permittees, the compliance schedule should be placed in a judicial order. Proper compliance with the schedule for implementing the controls recommended in the long-term CSO control plan constitutes compliance with the elements of this Policy concerning planning and implementation of a long term CSO remedy.

3. Phasing Considerations

Implementation of CSO controls may be phased based on the relative importance of and adverse impacts upon WQS and designated uses, as well as the permittee's financial capability and its previous efforts to control CSOs. The NPDES authority should evaluate the proposed implementation schedule and construction phasing discussed in Section II.C.8. of this Policy. The permit should require compliance with the controls proposed in the long-term CSO control plan no later than the applicable deadline(s) under the CWA or State law. If compliance with the Phase II permit is not possible, an enforceable schedule, consistent with the Enforcement and Compliance Section of this Policy, should be issued in conjunction with the Phase II permit which specifies the schedule and milestones for implementation of the long-term CSO control plan.

V. Enforcement and Compliance

A. Overview

It is important that permittees act immediately to take the necessary steps to comply with the CWA. The CSO enforcement effort will commence with

an initiative to address CSOs that discharge during dry weather, followed by an enforcement effort in conjunction with permitting CSOs discussed earlier in this Policy. Success of the enforcement effort will depend in large part upon expeditious action by NPDES authorities in issuing enforceable permits that include requirements both for the nine minimum controls and for compliance with all other requirements of the CWA. Priority for enforcement actions should be set based on environmental impacts or sensitive areas affected by CSOs.

As a further inducement for permittees to cooperate with this process, EPA is prepared to exercise its enforcement discretion in determining whether or not to seek civil penalties for past CSO violations if permittees meet the objectives and schedules of this Policy and do not have CSOs during dry weather.

B. Enforcement of CSO Dry Weather Discharge Prohibition

EPA intends to commence immediately an enforcement initiative against CSO permittees which have CWA violations due to CSOs during dry weather. Discharges during dry weather have always been prohibited by the NPDES program. Such discharges can create serious public health and water quality problems. EPA will use its CWA Section 308 monitoring, reporting, and inspection authorities, together with NPDES State authorities, to locate these violations, and to determine their causes. Appropriate remedies and penalties will be sought for CSOs during dry weather. EPA will provide NPDES authorities more specific guidance on this enforcement initiative separately.

C. Enforcement of Wet Weather CSO Requirements

Under the CWA, EPA can use several enforcement options to address permittees with CSOs. Those options directly applicable to this Policy are section 308 Information Requests, section 309(a) Administrative Orders, section 309(g) Administrative Penalty Orders, section 309 (b) and (d) Civil Judicial Actions, and section 504 Emergency Powers. NPDES States should use comparable means.

NPDES authorities should set priorities for enforcement based on environmental impacts or sensitive areas affected by CSOs. Permittees that have voluntarily initiated monitoring and are progressing expeditiously toward appropriate CSO controls should be given due consideration for their efforts.

1. Enforcement for Compliance With Phase I Permits

Enforcement for compliance with Phase I permits will focus on requirements to implement at least the nine minimum controls, and develop the long-term CSO control plan leading to compliance with the requirements of the CWA. Where immediate compliance with the Phase I permit is infeasible, the NPDES authority should issue an enforceable schedule, in concert with the Phase I permit, requiring compliance with the CWA and imposing compliance schedules with dates for each of the nine minimum controls as soon as practicable. All enforcement authorities should require compliance with the nine minimum controls no later than January 1, 1997. Where the NPDES authority is issuing an order with a compliance schedule for the nine minimum controls, this order should also include a schedule for development of the long-term CSO control plan.

If a CSO permittee fails to meet the final compliance date of the schedule, the NPDES authority should initiate appropriate judicial action.

2. Enforcement for Compliance With Phase II Permits

The main focus for enforcing compliance with Phase II permits will be to incorporate the long-term CSO control plan through a civil judicial action, an administrative order, or other enforceable mechanism requiring compliance with the CWA and imposing a compliance schedule with appropriate milestone dates necessary to implement the plan.

In general, a judicial order is the appropriate mechanism for incorporating the above provisions for Phase II. Administrative orders, however, may be appropriate for permittees whose long-term control plans will take less than five years to complete, and for minors that have complied with the final date of the enforceable order for compliance with their Phase I permit. If necessary, any of the nine minimum controls that have not been implemented by this time should be included in the terms of the judicial order.

D. Penalties

EPA is prepared not to seek civil penalties for past CSO violations, if permittees have no discharges during dry weather and meet the objectives and schedules of this Policy. Notwithstanding this, where a permittee has other significant CWA violations for which EPA or the State is taking judicial

action, penalties may be considered as part of that action for the following:

1. CSOs during dry weather;
2. Violations of CSO-related requirements in NPDES permits; consent decrees or court orders which predate this policy; or
3. Other CWA violations.

EPA will not seek penalties for past CSO violations from permittees that fully comply with the Phase I permit or enforceable order requiring compliance with the Phase I permit. For permittees that fail to comply, EPA will exercise its enforcement discretion in determining whether to seek penalties for the time period for which the compliance schedule was violated. If the milestone dates of the enforceable schedule are not achieved and penalties are sought, penalties should be calculated from the last milestone date that was met.

At the time of the judicial settlement imposing a compliance schedule implementing the Phase II permit requirements, EPA will not seek penalties for past CSO violations from permittees that fully comply with the enforceable order requiring compliance with the Phase I permit and if the terms of the judicial order are expeditiously agreed to on consent. However, stipulated penalties for violation of the judicial order generally should be included in the order, consistent with existing Agency policies. Additional guidance on stipulated penalties concerning long-term CSO controls and attainment of WQS will be issued.

Paperwork Reduction Act

The information collection requirements in this policy have been approved by the Office of Management and Budget (OMB) under the Paperwork Reduction Act, 44 U.S.C. 3501 *et seq* and have been assigned OMB control number 2040-0170.

This collection of information has an estimated reporting burden averaging 578 hours per response and an estimated annual recordkeeping burden averaging 25 hours per recordkeeper. These estimates include time for reviewing instructions, searching existing data sources, gathering and maintaining the data needed, and completing and reviewing the collection of information.

Send comments regarding the burden estimate or any other aspect of this collection of information, including suggestions for reducing this burden to Chief, Information Policy Branch; EPA; 401 M Street SW. (Mail Code 2136); Washington, DC 20460; and to the Office of Information and Regulatory Affairs, Office of Management and

18698 **Federal Register / Vol. 59, No. 75 / Tuesday, April 19, 1994 / Notices**

Budget, Washington, DC 20503, marked
"Attention: Desk Officer for EPA."

[FR Doc. 94-9295 Filed 4-18-94; 8:45 am]

BILLING CODE 8500-50-P

A.3 Memorandum: Addition of Chapter X to Enforcement Management System

March 7, 1996

MEMORANDUM

SUBJECT: Addition of Chapter X to Enforcement Management System (EMS): Setting Priorities for Addressing Discharges from Separate Sanitary Sewers

FROM: Steven A. Herman [SIGNED]
Assistant Administrator

TO: Water Management Division Directors, Regions I-X
NPDES State Enforcement Directors
Regional Counsels, Regions I-X

I am pleased to transmit to you a new chapter in final form for the Enforcement Management System (EMS) Guide. This new chapter provides a method of setting priorities for addressing discharges of untreated sewage from separate sanitary sewer collection systems prior to the headworks of a sewage treatment plant. Included with this chapter is an Enforcement Response Guide, specifically tailored to these types of discharges.

I want to express my appreciation to those Regional, Headquarters, State personnel, and the members of the Federal Advisory Sub-Committee for Sanitary Sewer Overflows (SSO) who helped develop this document. The Advisory Sub-Committee reviewed it at two public meetings in August and October, 1995. The cooperation and hard work of all interested parties has produced this final document which I believe will help protect public health and the environment from these serious sources of water pollution.

This guidance supplements the current EMS by establishing a series of guiding principles and priorities for use by EPA Regions and NPDES States in responding to separate sanitary sewer discharge violations. The guidance allows sufficient flexibility to alter these priorities based on the degree of public health or environmental risk presented by specific discharge conditions. Implementation of this guidance by EPA and the States will promote national consistency in addressing discharges from separate sanitary sewers. Implementation will also ensure that

- 2 -

enforcement resources are used in ways that maximize public health and environmental benefits.

The Regions should ensure that all approved States are aware of this additional EMS guidance, and the Regions and NPDES States should begin the process of modifying their written EMS documents to include it. Both Regions and States should have these documents revised and implemented no later than November 15, 1996.

If you have questions about this document, please feel free to contact Brian J. Maas, Director, Water Enforcement Division (202/564-2240), or Kevin Bell of his staff (202/564-4027).

cc: Mike Cook, OWM

A.4 Enforcement Management System - Chapter X

THE ENFORCEMENT MANAGEMENT SYSTEM
NATIONAL POLLUTANT DISCHARGE ELIMINATION SYSTEM
(CLEAN WATER ACT)

**CHAPTER X: Setting Priorities for Addressing Discharges
from Separate Sanitary Sewers**

U.S. ENVIRONMENTAL PROTECTION AGENCY
OFFICE OF REGULATORY ENFORCEMENT

1996

ENFORCEMENT MANAGEMENT SYSTEM - CHAPTER X

Setting Priorities for Addressing Discharges from Separate Sanitary Sewers

Discharges of raw or diluted sewage from separate sanitary sewers before treatment can cause significant public health and environmental problems. The exposure of the public to these discharges and the potential health and environmental impacts are the primary reasons EPA is developing this additional guidance on these discharges. This document provides a method of setting priorities for regulatory response, and serves as a supplement to the Enforcement Management System guidance (EMS, revised February 27, 1986). As such, this document addresses only those discharges which are in violation of the Clean Water Act. As a general rule, the discharges covered by this guidance constitute a subset of all discharges from separate sanitary sewer systems.

Legal Status

In the context of this document, a "discharge from a separate sanitary sewer system" (or "discharge") is defined as any wastewater (including that combined with rainfall induced infiltration/inflow) which is discharged from a separate sanitary sewer that reaches waters of the United States prior to treatment at a wastewater treatment plant. Some permits have specific requirements for these discharges, others have specific prohibitions under most circumstances, and still other permits are silent on the status of these discharges.

The legal status of any of these discharges is specifically related to the permit language and the circumstances under which the discharge occurs. Many permits authorize these discharges when there are no feasible alternatives, such as when there are circumstances beyond the control of the municipality (similar to the concepts in the bypass regulation at 40 CFR Part 122.41 (m)). Other permits allow these discharges when specific requirements are met, such as effluent limitations and monitoring/reporting.

Most permits require that any non-compliance including overflows be reported at the end of each month with the discharge monitoring report (DMR) submittal. As a minimum, permits generally require that overflow summaries include the date, time, duration, location, estimated volume, cause, as well as any observed environmental impacts, and what actions were taken or are being taken to address the overflow. Most permits also require that any non-compliance including overflows which may endanger health or the environment be reported within 24 hours, and in writing within five days. Examples of overflows which may endanger health or the environment include major line breaks, overflow events which result in fish kills or other significant harm, and overflow events which occur in environmentally sensitive areas.

For a person to be in violation of the Clean Water Act:

1) a person must own, operate, or have substantial control over the conveyance from which the discharge of pollutants occurs, 2) the discharge must be prohibited by a permit, be a violation of the permit language, or not be authorized by a permit, and 3) the discharge must reach waters of the United States. In addition, discharges that do not reach waters of the United States may nevertheless be in violation of Clean Water Act permit requirements, such as those requiring proper operation and maintenance (O&M), or may be in violation of state law.

Statement of Principles

The following six principles should be considered as EPA Regions and States set priorities for addressing violating discharges from separate sanitary sewers:

1. All discharges (wet weather or dry weather) which cause or contribute significantly to water quality or public health problems (such as a discharge to a public drinking water supply) should be addressed as soon as physically and financially possible. Other discharges may, if appropriate, be addressed in the context of watershed/basin plans (in conjunction with state or federal NPDES authorities).
2. Discharges which occur in high public use or public access areas and thus expose the public to discharges of raw sewage (i.e., discharges which occur in residential or business areas, near or within parks or recreation areas, etc.) should be addressed as soon as physically and financially possible.
3. Dry weather discharges should be addressed as soon as physically and financially possible.
4. Discharges due to inadequate operation and routine maintenance should be addressed as soon as possible. (Physical and financial considerations should be taken into account only in cases where overflow remedies are capital intensive.)
5. Discharges which could be addressed through a comprehensive preventive maintenance program or with minor capital investment should be addressed as soon as physically and financially possible.
6. With respect to principles 1 through 5 above, schedules of compliance which require significant capital investments should take into account the financial capabilities of the specific

municipality, as well as any procedures required by state and local law for publicly owned facilities in planning, design, bid, award, and construction. (See later sections on Schedules).

Causes of Sanitary Sewer Discharges

Discharges from separate sanitary sewers can be caused by a variety of factors including, but not limited to:

1. Inadequate O&M of the collection system. For example, failure to routinely clean out pipes, failure to properly seal or maintain manholes, failure to have regular maintenance of deteriorating sewer lines, failure to remedy poor construction, failure to design and implement a long term replacement or rehabilitation program for an aging system, failure to deal expeditiously with line blockages, or failure to maintain pump stations (including back-up power).
2. Inadequate capacity of the sewer system so that systems which experience increases in flow during storm events are unable to convey the sewage to the wastewater treatment plant. For example, allowing new development without modeling to determine the impact on downstream pipe capacity, insufficient allowance for extraneous flows in initial pipe design (e.g. unapproved connection of area drains, roof leaders, foundation drains), or overly optimistic Infiltration/Inflow reduction calculations.
3. Insufficient capacity at the wastewater treatment plant so that discharges from the collection system must occur on a regular basis to limit flows to the treatment plant. For example, basic plant designs which do not allow sufficient design capacity for storm flows.
4. Vandalism and/or facility or pipeline failures which occur independent of adequate O&M practices.

Applicable Guidance

For many years, EPA and the States have been working with municipalities to prevent discharges from separate sanitary sewer systems. The preferred method has been to use the general policy on responding to all violations of the Clean Water Act which is contained in the EMS guidance. Factors which are considered are the frequency, magnitude, and duration of the violations, the environmental/public health impacts, and the culpability of the violator. This guidance sets up a series of guiding principles for responding to separate sanitary sewer discharge violations,

and it supplements the current EMS.

Every EPA Region and State uses some form of this general enforcement response guidance as appropriate to the individual state processes and authorities. Under the guidance, various EPA Regions and States have taken a large number of formal enforcement actions over the past several years to address sanitary sewer discharge problems across the country. Responses have included administrative orders and/or civil judicial actions against larger municipalities to address sanitary sewer discharge problems, resulting in substantial injunctive relief in some cases.

As a result of EPA Region and State enforcement efforts, a number of municipalities have invested substantial resources in diagnostic evaluations and designing, staffing, and implementing O&M plans. Other municipalities have undertaken major rehabilitation efforts and/or new construction to prevent sanitary sewer discharges.

Priorities for Response

There are approximately 18,500 municipal separate sanitary sewage collection systems (serving a population of 135 million), all of which can, under certain circumstances, experience discharges. Given this fact, the Agency has developed a list of priorities in dealing with the broad spectrum of separate sanitary sewer discharges to ensure that the finite enforcement resources of EPA and the States are used in ways that result in maximum environmental and public health benefit. However, these priorities should be altered in a specific situation by the degree of health or environmental risks presented by the condition(s).

In the absence of site-specific information, all separate sanitary sewer discharges should be considered high risk because such discharges of raw sewage may present a serious public health and/or environmental threat. Accordingly, first priority should be given within categories (such as dry weather discharges and wet weather discharges) to those discharges which can be most quickly addressed. The priority scheme listed below takes this into account by first ensuring that municipalities are taking all necessary steps to properly operate and maintain their sewerage systems. Corrective action for basic O&M is typically accomplished in a short time, and can yield significant public health and environmental results.

Risk again becomes a determinant factor when conditions

warrant long term corrective action. The goal here should be to ensure that capital intensive, lengthy compliance projects are prioritized to derive maximum health and environmental gains.

The priorities for correcting separate sanitary sewer discharges are typically as follows:

- 1) Dry weather, O&M related: examples include lift stations or pumps that are not coordinated, a treatment plant that is not adjusted according to the influent flow, poor communication between field crews and management, infiltration/inflow, and/or pretreatment problems.
- 2) Dry weather, preventive maintenance related: examples include pumps that fail due to poor maintenance, improperly calibrated flow meters and remote monitoring equipment, insufficient maintenance staff, deteriorated pipes, and/or sewers that are not cleaned regularly.
- 3) Dry weather, capacity related: examples include an insufficient number or undersized pumps or lift stations, undersized pipes, and/or insufficient plant capacity.
- 4) Wet weather, O&M related: examples include excessive inflow and/or infiltration (such as from improperly sealed manhole covers), inadequate pretreatment program (i.e. excessive industrial connections without regard to line capacity), uncoordinated pump operations, treatment plant operation that is not adjusted according to the influent flow, poor coordination between field crews and management, illegal connections, and/or no coordination between weather forecast authorities and sewer system management.
- 5) Wet weather, preventive maintenance related: examples include poor pump maintenance leading to failure, improperly calibrated flow meters and remote monitoring equipment, insufficient maintenance staff, and/or sewers that are not cleaned regularly.
- 6) Wet weather, O&M minor capital improvement related: examples include the upgrading of monitoring equipment, pumps, or computer programs, and/or repair or replacement of broken manholes or collapsed pipes.
- 7) Wet weather capacity, quick solution related: examples include a known collection system segment that is a "bottleneck", pumps beyond repair in need of replacement, and/or need for additional crews or technical staff.

8) Wet weather, capacity, health impact related requiring long term corrective action: examples include frequent discharges to public recreational areas, shellfish beds, and/or poor pretreatment where the total flow is large.

9) Wet weather, capacity, sensitive area related requiring long term corrective action: examples include discharges to ecologically and environmentally sensitive areas, as defined by State or Federal government.

Selecting A Response

The appropriate regulatory response and permittee response for separate sanitary sewer discharges will depend on the specifics of each case. The regulatory response can be informal, formal, or some combination thereof. Typical regulatory responses include a phone call, Letter of Violation (LOV), Section 308 Information Request, Administrative Order (AO), Administrative Penalty Order (APO), and/or judicial action. The permittee response can range from providing any required information to low cost, non-capital or low capital improvements to more capital intensive discharge control plans.

The attached chart lists some categories of separate sanitary sewer noncompliance along with the range of response for each instance. The chart is intended as a guide. The responses listed on the chart are not to be considered mandatory responses in any given situation. EPA and the States should use the full range of regulatory response options (informal, formal, or some combination thereof) to ensure that the appropriate response or remedy is undertaken by the permittee or municipality. All regulatory responses should be in accordance with the concept of the EMS regarding orderly escalation of enforcement action.

Developing Compliance Schedules

A compliance schedule should allow adequate time for all phases of a sanitary sewer discharge control program, including development of an O&M plan, diagnostic evaluation of the collector system, construction, and enhanced O&M. Municipalities should be given a reasonable length of time to develop schedules so they can realistically assess their compliance needs, examine their financing alternatives, and work out reasonable schedules for achieving compliance. Nevertheless, timelines for schedules should be as short as physically and financially possible.

Short Term Schedules

In general, short term schedules would be appropriate for sanitary sewer discharges involving O&M problems, or where only minor capital expenses are needed to correct the problem. The schedule should have interim dates and a final compliance date incorporated in the administrative order or enforcement mechanism.

Comprehensive Discharge Control Schedules

Comprehensive discharge control schedules should be used where specific measures must be taken to correct the discharges, and the measures are complicated, costly, or require a significant period of time to implement. If appropriate, these schedules should include the use of temporary measures to address high impact problems, especially where a long term project is required to correct the sanitary sewer discharge violation.

When working with municipalities to develop comprehensive schedules, EPA Regions and States should be sensitive to their special problems and needs, including consideration of a municipality's financial picture. Factors that should be considered are the municipality's current bond rating, the amount of outstanding indebtedness, population and income information, grant eligibility and past grant experience, the presence or absence of user charges, and whether increased user charges would be an effective fund-raising mechanism, and a comparison of user charges with other municipalities of similar size and population.

Physical capability should be considered when schedules are developed. Schedules should include interim milestones and intermediate relief based on sound construction techniques and scheduling such as critical path method. Compliance schedules should be based on current sewer system physical inspection data adequate to design sanitary sewer discharge control facilities. Schedules should not normally require extraordinary measures such as overtime, short bidding times, or other accelerated building techniques. Where possible, schedule development should be completed according to normal municipal government contracting requirements.

Financial capability should also be considered in schedule development, including fiscally sound municipal financing techniques such as issuing revenue bonds, staging bond issuance, sequencing project starts, sensitivity to rate increase percentages over time.

Note: The intent of this guidance is to aid the Regions and States in setting priorities for enforcement actions based on limited resources and the need to provide a consistent level of response to violations. This does not represent final Agency action, but is intended solely as guidance. This guidance is not intended for use in pleading, or at hearing or trial. It does not create any rights, duties, obligations, or defenses, implied or otherwise, in any third parties. This guidance supplements the Agency's Enforcement Management System Guide (revised February 27, 1986).

**ENFORCEMENT RESPONSE GUIDE
DISCHARGES FROM SEPARATE SANITARY SEWERS**

<u>NONCOMPLIANCE</u>	<u>CIRCUMSTANCES</u>	<u>RANGE OF RESPONSE</u>
Discharge without a permit or in violation of general prohibition	Isolated & infrequent, dry weather O&M related	Phone call, LOV, 308 request
Discharge without a permit or in violation of general prohibition	Isolated & infrequent, dry weather capacity related	308 request, AO, APO, Judicial action
Discharge without a permit or in violation of general prohibition	Isolated & infrequent, wet weather O&M related	Phone call, LOV, 308 request
Discharge without a permit or in violation of general prohibition	Isolated & infrequent, wet weather, quick and easy solution	LOV, 308 request
Discharge without a permit or in violation of general prohibition	Isolated & infrequent, wet weather capacity related, health and/or sensitive areas	LOV, 308 request, AO, APO
Discharge without a permit or in violation of general prohibition	Isolated & infrequent, wet weather capacity related, non-health, non-sensitive areas	Phone call, LOV, 308 request
Discharge without a permit or in violation of general prohibition	Cause unknown	Phone call, LOV, 308 request
Discharge without a permit or in violation of general prohibition	Permittee does not respond to letters; does not follow through on verbal or written agreement	AO, APO, judicial action
Discharge without a permit or in violation of general prohibition	Frequent, does not significantly affect water quality, no potential public health impact	LOV, 308 request, AO, APO
Discharge without a permit or in violation of general prohibition	Frequent, cause or contribute significantly to WQ problems, or occur in high public use and public access areas, or otherwise affect public health	AO, APO, judicial action

- 2 -

**ENFORCEMENT RESPONSE GUIDE
DISCHARGES FROM SEPARATE SANITARY SEWERS**

<u>NONCOMPLIANCE</u>	<u>CIRCUMSTANCES</u>	<u>RANGE OF RESPONSE</u>
Missed interim date in CDCP	Will not cause late final date or other interim dates	LOV
Missed interim date in CDCP	Will result in other missed dates, no good and valid cause	LOV, AO, APO, judicial action
Missed final date in CDCP	Violation due to force majeure	Contact permittee and require documentation of good or valid cause
Missed final date in CDCP	Failure or refusal to comply without good and valid cause	AO, APO or judicial action
Failure to report overflows (as specified in permit)	Isolated and infrequent, health related	Phone call, LOV, AO, APO
Failure to report overflows (as specified in permit)	Isolated and infrequent, water quality and environment related	Phone call, LOV, AO, APO
Failure to report overflows (as specified in permit)	Permittee does not respond to letters, does not follow through on verbal or written agreement, or frequent violation	AO, APO, judicial action, request for criminal investigation
Failure to report permit requirements	Any instance	Phone, LOV, AO, APO

CDCP=Comprehensive Discharge Control Plan

Appendix B

Human Health Expert and Stakeholder Meeting Summaries

B.1 Summary of the August 14 - 15, 2002,
Experts Workshop on Public
Health Impacts of Sewer Overflows
(Abstract and Background)

B.2 Stakeholder Meeting Summary,
Washington, D.C.

B.3 Stakeholder Meeting Summary,
Huntington Beach, CA

B.1 Summary of the August 14-15, 2002, Experts Workshop on Public Health Impacts of Sewer Overflows (Abstract and Background)

United States
Environmental Protection
Agency

Office of Wastewater Management
Washington, D.C. 20460
www.epa.gov/npdes

EPA 833-R-02-002
November 2002



Summary of the August 14 – 15, 2002, Experts Workshop on Public Health Impacts of Sewer Overflows

Summary of the August 14 – 15, 2002, Experts Workshop on Public Health Impacts of Sewer Overflows

Table of Contents

Abstract.....	1
Background.....	1
Rationale for the Workshop.....	1
Opening Remarks.....	3
Review of Goals and Agenda.....	3
Overview of the 2001 and 2003 Reports to Congress.....	5
The Public Health Chapter of the 2003 CSO/SSO Report to Congress:	
Questions and Proposed Methods.....	8
Discussion Session 1: Characterizing Pathogens and Pollutants.....	13
Discussion Session 2: Pathways of Exposure.....	22
Discussion Session 3: Open Discussion Session.....	25
Welcome and Structure of Day Two.....	26
Breakout Session A: Significance of the CSO and SSO Problem.....	26
Breakout Session B: Options for the Current Study.....	28
General Discussion.....	30
Final Comments and Next Steps.....	31

Appendices

Appendix A: Attendee List

Appendix B: Agenda

Appendix C: Clarifying Questions from Observers

Appendix D: The Public Involvement Process for the 2001 and 2003 Reports to Congress

Abstract

In embarking upon the task of assessing the human health impact portion of Congress' request for a report on the impacts and control of sewer overflows in the United States, initial research revealed that relatively little data were available that linked waterborne illness or other exposures to combined sewer overflows (CSOs) and sanitary sewer overflows (SSOs). In response to these challenges, EPA held a Public Health Impacts Experts Workshop on August 14 and 15, 2002. A group of nine external and EPA experts in public health, epidemiology, and wastewater treatment attended the workshop. Observers included representatives of stakeholder groups and EPA personnel. This workshop did not constitute an advisory committee under the Federal Advisory Committees Act (FACA), but rather solicited individual opinions and provided a forum for information exchange related to this Report to Congress.

Background

In the Consolidated Appropriations Act for fiscal year 2001, also known as the “Wet Weather Water Quality Act of 2000” or “2000 Amendments to the Clean Water Act” (CWA), Congress made several changes to the CWA regarding combined sewer overflows (CSOs) (P.L. 106-554). Among these changes was a requirement for the U.S. Environmental Protection Agency (EPA) to provide two Reports to Congress. The first report, *Implementation and Enforcement of the Combined Sewer Overflow Control Policy* (EPA 833-R-01-003), was delivered on January 29, 2002. The second report, which is due to Congress on December 15, 2003, is to investigate:

- The extent of the human health and environmental impacts caused by municipal CSOs and sanitary sewer overflows (SSOs), including the location of discharges causing such impacts, the volume of pollutants discharged, and the constituents discharged;
- The resources spent by municipalities to address these impacts; and
- An evaluation of the technologies used by municipalities to address these impacts.

Rationale for the Public Health Experts Workshop

In embarking upon the task of assessing the human health impact portion of Congress' request, initial research revealed that relatively little data were available that linked waterborne illness or other exposures to CSOs and SSOs. Factors complicating collection of information and data in this arena include public perception of reporting overflows in recreational areas; difficulty in contributing CSO/SSO loadings of pathogens in our nation's waters from other background sources; multiple possible pathways for fecal-related illness; underreporting of certain types of waterborne illnesses; and a lack of comprehensive local or national tracking for such illnesses.

In response to these challenges, EPA held a Public Health Impacts Experts Workshop on August 14 and 15, 2002. The purpose of this workshop was to enlist technical and subject matter experts from federal agencies, local health departments, and academia to ensure that EPA frames the study questions correctly, benefits from all pertinent data, and develops a methodology that bears out actual experiences. A group of recognized experts in the field of public health and interested observers met with the goals and objectives of:

- Fully elucidating the issues and the magnitude of those issues associated with health impacts of CSOs and SSOs;
- Reviewing and supplementing data and information sources identified to date; and
- Critiquing the proposed methodology for gathering and analyzing the public health information and data for the 2003 report.

The experts were asked to give individual opinions relating to the study questions. No consensus opinions or policy recommendations were solicited.

This Public Health Experts workshop is part of a larger public involvement process for the 2001 and 2003 CSO/SSO Reports to Congress. It occurs between two broader stakeholders' meetings (June 2001 and summer 2003, anticipated), at which a broad range of stakeholders discuss and provide input on draft report findings and recommendations, experiences in CSO control, and future policy and program directions. For a more detailed discussion of the overall stakeholder approach, please refer to Appendix D of this summary.

B.2 Stakeholder Meeting Summary, Washington, D.C.

2003 Report to Congress on the Impacts and Control of Combined Sewer Overflows and Sanitary Sewer Overflows

Stakeholder Meeting Summary Washington, D.C.

On June 23 and 24, 2003, the U.S. Environmental Protection Agency held a meeting in Washington, D.C., to discuss the upcoming Report to Congress on the impacts and control of CSOs and SSOs. The meeting held at the Renaissance Hotel, 999 9th St. NW, provided an opportunity for EPA to present the results of the data collection, request verification of information and data sources, and solicit feedback on preliminary findings and interpretation.

The main goals of the meeting were to:

- Discuss the data, report methodology, and analysis of the 2003 Report to Congress;
- Discuss implications of the major analyses in the report; and
- Discuss participants' experiences in controlling impacts from CSOs and SSOs.

The summary below describes the presentations given to outline the contents of the report and recounts the resulting discussions. The summary is organized into the following major sections, which correspond to the meeting agenda:

- Opening Remarks
- Background on the Report
- Characterization of CSOs and SSOs
- Environmental Impacts of CSOs and SSOs
- Closing Remarks, Day One
- Recap of Day One and Agenda Review for Day Two
- Welcome and Opening Remarks, Day Two
- Human Health Impacts of CSOs and SSOs
- Technologies for CSO and SSO Control
- Resources Spent Addressing CSOs and SSOs
- Common Themes Heard During the Meeting
- Closing Remarks, Day Two

Opening Remarks

James A. Hanlon – Director, Office of Wastewater Management, EPA

Mr. Hanlon opened the meeting by welcoming the participants to Washington, D.C., and providing an overview of the 2000 Wet Weather Water Quality Act, the 2001 CSO Report to Congress, and its associated stakeholder meeting. Mr. Hanlon reminded the participants that this Report was not intended to set policy, instead it was intended to present data and cite additional data sources that Congress could look to when entering into policy discussions. He mentioned that responding to the charge from Congress had proven difficult, specifically in identifying loadings and in correlating discharges with environmental and human health impacts.

Background on the 2003 Report to Congress

Kevin DeBell – Office of Wastewater Management, EPA

Mr. DeBell presented the background to the 2003 Report to Congress. He started by mentioning the near-term EPA policies that directly led to the request for the 2003 Report to Congress. First, he described the 1994 National CSO Control Policy which formalized EPA's management expectations for CSS communities. Next, a summary of the 2001 *Report to Congress – Implementation and Enforcement of the Combined Sewer Overflow Control Policy* was presented. This report acted as a program evaluation in which success of CSO Control Policy implementation was assessed; one useful product of the 2001 Report is the CSO database, which includes information on all CSO permits. Mr. DeBell then mentioned the draft SSO Notice of Proposed Rulemaking, and the 2000 Wet Weather Water Quality Act, which required the 2003 Report. The statutory requirements for the 2003 Report are stated below:

The Administrator of the Environmental Protection Agency shall transmit to Congress a report summarizing:

- a. *the extent of human health and environmental impacts caused by municipal combined sewer overflows and sanitary sewer overflows, including the location of discharges causing such impacts, the volume of pollutants discharged, and the constituents discharged;*
- b. *resources spent by municipalities to address these impacts; and*
- c. *an evaluation of the technologies used by municipalities to address these impacts.*

Mr. DeBell next explained that EPA is not required to have a public review of Reports to Congress, but that this particular program has a legacy of stakeholder collaboration, which EPA values.

Finally, Mr. DeBell presented the report outline. The report is organized as follows:

- Introduction
- Background
- Methodology
- Characteristics of CSOs and SSOs
- Environmental Impacts of CSOs and SSOs
- Human Health Impacts of CSOs and SSOs
- Federal and State Actions to Control CSOs and SSOs
- Technologies Used to Reduce the Impacts of CSOs and SSOs
- Findings and Recommendations

Stakeholder Questions and Comments on the Background Presentation

Questions and comments received after the background presentation are summarized below. The comments represent stakeholder opinion(s) and may not reflect EPA's position.

- Are data collected during the Report to Congress effort also being used to inform the SSO economic analysis?
- Is EPA still attempting to make an economic model to justify the SSO Rule, despite the fact that the public health experts (during the August 2002 Experts Workshop) said that an economic model was not feasible?
- In relation to municipalities' actions on CSOs and SSOs, will the Report to Congress help municipalities prioritize resources spent on CSO/SSO versus other wet weather events?
- Regarding the Pretreatment Rule streamlining, enforcement of this rule may reduce the human health risks associated with CSOs and SSOs fed by industrial wastewater flows during wet weather. Has EPA consulted with municipalities regarding enforcement of this rule?
- Will the SSO/CSO data (compiled for both Reports to Congress) be publicly available? When?
- Some stakeholders were worried about the lack of representation at the stakeholder meeting from certain stakeholder groups (i.e., NOAA and public health officials) and urged EPA to try to increase representation from each group.

- A stakeholder pointed out that many enforcement actions and consent decrees are currently in place (for CSO and SSO violations), and wanted to ensure that these actions were represented in the report.

Characterization of CSOs and SSOs

Kevin DeBell – Office of Wastewater Management, EPA

Mr. DeBell presented data on the location of CSO and SSO discharges, the volume of pollutants discharged, the constituents discharged, and the frequency of discharge events.

This presentation defined a CSO as a mixture of untreated sewage and storm water discharged from a combined sewer system at a point prior to the headworks of the POTW. Generally, CSOs occur during wet weather when the CSS becomes overloaded. SSO is defined as a discharge of untreated or partially treated wastewater from a sanitary sewer system at any point prior to the headworks of a POTW. Backups of wastewater to private property are not included in the definition of SSO used for this Report to Congress.

Data Sources for the Characterization Chapter

EPA used the following data sources to characterize CSOs and SSOs.

- State databases for tracking CSO and SSO events;
- NPDES permit files;
- Approximately 80 interviews with state and municipal officials;
- LTCPs and other capital improvement documentation;
- Literature review; and
- Existing EPA documentation, including technical reports and products of cooperative agreements.

Key Research Questions for the Characterization Chapter

This presentation introduced three key research questions for the characterization chapter:

- How many NPDES permits exist for combined sewer systems and sanitary sewer systems?
- What are the common pollutants found in CSOs and SSOs?
- What are the volume, frequency, and location of CSOs and SSOs?

Stakeholder Questions and Comments for the Characterization Chapter

Questions and comments received after the characterization presentation are summarized below. The comments represent stakeholder opinion(s) and may not reflect EPA's position.

- With respect to the pollutants and pathogens found in CSOs and SSOs, specifically concentrations, stakeholders questioned the accuracy of the data presented in the meeting and asked that it be verified. Stakeholders identified possible data sources, including the Nationwide Urban Runoff Program and Hydraulic Characteristic Reports (needed for NPDES permits).
- The concentrations of constituents within CSOs, SSOs, and storm water vary widely, depending on many factors, such as the amount of precipitation or sources contributing to the wastewater. Therefore, it is very difficult to present general characteristics. Stakeholders questioned whether CSOs and SSOs should be characterized in this fashion. Some suggested concentrating on specific and acute impacts.
- Stakeholders suggested that EPA take a look at “hot spots” or incidents of the most dangerous, concentrated CSOs and SSOs.
- Stakeholders suggested that EPA express to Congress what can be supported by available data— local, acute impacts can be terrible, while the national impact looks relatively small; both are very difficult to track or assess.

- Stakeholders said the information presented in this section needed to be placed in the context of the environmental and human health impacts.
- Do not present data in aggregate format. For example, separate wet weather and dry weather SSO data.
- Characteristics of the receiving water need to be addressed.
- More specificity is needed. Add community data where available, including volume, cause, and receiving water information. A stakeholder thought that this would help Congress better understand why national data are and are not representative.
- Stakeholders asked for clarification of the charge from Congress. Was the directive to look at municipalities only or also at decentralized wastewater treatment systems?
- Stakeholders were concerned that describing the volume of current CSO discharges as “a large amount” would give Congress the impression that municipalities were not doing anything to correct the CSO problem.
- Were small communities contacted and interviewed in this methodology?
- A clarifying question was asked regarding the statistic on the amount of SSOs that reach waterbodies and how researchers were estimating the impact on sensitive areas.
- Concerns were raised about how information presented in this report was going to inform Congress’s decisions regarding wet weather policy as a whole.

Environmental Impacts of CSOs and SSOs

Julia Moore – Limno-Tech, Inc.

Ms. Moore began by defining “environmental impacts” as water quality, aquatic life, and aesthetic impacts that affect designated uses. Violations of water quality standards were used as an indicator for environmental impacts. While researching this chapter, EPA used previously completed national, state, and local assessments. Literature and web searches were performed and interviews with state and municipal officials were carried out.

EPA sought to characterize types of environmental impacts from CSOs and SSOs. First, EPA presented ranges in concentrations of the constituents typically found in CSOs and SSOs. EPA presented the results of assessments of environmental impacts caused by CSOs and SSOs. EPA acknowledged that while beach closures and shellfish bed closures have been traced to CSOs and SSOs, the data are not complete.

EPA described planned national assessments in which CSO outfall locations will be integrated with EPA’s WATERS database. This will allow CSO locations to be associated with information such as 303(d) impaired reaches and drinking water intakes.

Conclusions for the Environmental Impacts Chapter

EPA presented preliminary conclusions regarding the environmental impacts from CSOs and SSOs. These included:

- CSOs and SSOs contain pollutants that cause impairments to designated uses, as reported in national assessments.
- CSOs and SSOs can be a principal cause or a contributing cause of an environmental impact.
- National data are inconsistent in tracking CSOs and SSOs as a direct cause of impairment.
- While data are not comprehensive, some national estimates of use impairment have been made.
- State and local examples of cause and effect exist where CSO and SSO reporting and tracking are undertaken.

EPA asked the stakeholders present at the meeting for additional information on documented environmental impacts from CSOs and SSOs.

Stakeholder Questions and Comments on the Environmental Impacts Chapter

Questions and comments received after the environmental impacts presentation are summarized below. The comments represent stakeholder opinion(s) and may not reflect EPA's position.

- Need to put a greater emphasis on water quality impacts.
- Need to do a better job of conveying that the data are all anecdotal.
- Researchers have only presented suspicion of impacts.
- Regarding the concentrations of metals in CSOs, some stakeholders commented that most metal contamination comes from storm water and that CSO controls would not make a difference.
- In the presentation, it was stated that dry weather SSOs were responsible for 7 percent of the total volume discharged annually. Stakeholders were interested in the characteristics of the other 93 percent of the SSO events contributing to the volume to determine if dry weather overflows are a problem.
- Some stakeholders expressed the opinion that in urban watersheds, current water quality standards are impossible to meet during wet weather and that even without CSO or SSO discharges, waterbodies would exceed water quality standards.
- Stakeholders questioned the source of pathogen data. They stated that municipalities would argue strongly against the source allocation and mentioned the new Santa Ana Regional Water Quality Control Board beach closure study in California, which attributed most beach closures to urban runoff. The stakeholders also mentioned the Four Mile Run TMDL study, in Virginia, in order to clarify pathogen source information. As a follow up to this comment, it was mentioned that stormwater may be impacted by cross-connections or SSOs.
- Stakeholders reiterated the need to characterize both dry and wet weather SSOs and CSOs, specifically stating that the sources of pathogens vary widely depending on whether the event takes place during dry weather or wet weather.
- A stakeholder commenting on the North Carolina example stated that none of the overflows highlighted in the presentation appeared to be attributed to wet weather.
- Stakeholders questioned the concentration of metals being contributed to receiving waters via CSOs.
- Regarding shellfish advisories, stakeholders commented that over 90 percent of these were due to stormwater, not CSOs.
- Stakeholders challenged the research team to find fish kills that occurred during wet weather as a result of CSOs or SSOs. They doubted this had happened.
- Regarding the Ohio River study, stakeholders commented that urban runoff contributes more pollutants and pathogens than the CSOs, so removal of CSOs will not show different results.
- Stakeholders stated that many pathogen source studies performed to date showed that primary sources of pathogens were not of human origin (specifically mentioned studies in Chicago, Detroit, and Milwaukee). Other stakeholders disagreed, citing Lake Michigan studies.
- Stakeholders pointed out that constituents in CSOs and SSOs can vary. One stakeholder was particularly concerned about hospital sewage and radionuclide contamination.
- One stakeholder mentioned that it is still very difficult to attribute pathogens to their source. The stakeholder said that source tracking is still in the research stage and suggested that the technology be used to monitor CSOs and SSOs. The stakeholder did not agree that current data “show no human impact” and mentioned that some studies have shown higher human viral concentrations at overflow sites.
- From a local perspective, stakeholders mentioned that there are other wet weather sources about which Congress needs to know in order to prioritize funding. Stakeholders wanted to know if this report would help Congress do that.
- Stakeholders wanted to know what studies were chosen and why.
- Can we make gross estimates about how often CSOs or SSOs will push waterbodies into non-attainment?
- Regarding the amount of Great Lakes shoreline reported impaired, does EPA know the amount of shoreline assessed?

- Regulations currently focus on the most easily regulated communities. There is much disagreement over how much implementing control regulations will cost. Will the Report to Congress help remedy this?

Closing Remarks, Day One

Benita Best-Wong – Office of Wastewater Management, EPA

Ms. Best-Wong stated that stakeholder comments would inform the report. She also reminded the audience that the report was not intended to cover all wet weather events and policy, and therefore, some of the stakeholder questions were beyond the scope of this report. Ms. Best-Wong then touched on the Office of Water's watershed management approach, which focuses on many of the other issues raised during the first day.

Recap of Day One & Agenda Review for Day Two

Linda Manning – Facilitator, SRA International

Ms. Manning described some of the main themes from the previous day, which centered around the accuracy of data. The themes included:

- Do not oversell the data or paint with too broad a brush;
- Get a local flavor; it is important to present local impacts;
- Fully explain the limitations in the data and be clear about the data gaps;
- Do not have interpretational bias;
- Be clear about the data gaps and provide the clear message that more data are needed;
- Make sure the report is useful by providing context and placing the issues in relation to other wet weather events;
- Acknowledge variability in the data; and
- Address big picture policy questions.

Welcome and Opening Remarks, Day Two

Ben Grumbles – Deputy Assistant Administrator for Water, EPA

Mr. Grumbles talked about the importance of the report as well as the importance of the stakeholder involvement process. He mentioned the challenges confronting the Office of Water in the 21st century and the resulting shift of EPA's focus from point source controls to a more holistic watershed approach. Mr. Grumbles touched on the history of the Wet Weather Water Quality Act and Congress's intention for the Report. He stressed the need for increased monitoring and data gathering to make more informed policy decisions. Mr. Grumbles addressed the following comments and questions from the stakeholders.

Question/Comment: Progress needs to be made regarding EPA's policy on the blending of treated and partially untreated wastewater at POTWs during wet weather.

Response: EPA is very much engaged in the blending issue and asked the stakeholders to provide any information they have on the use of blending to manage wet weather flows.

Question/Comment: Too much government regulation and intervention runs the risk of dictating technology, which, in turn, may stymie development of innovative alternatives.

Response: The current EPA leadership is very sensitive to the danger of dictating too much and understands that EPA needs to be open-minded when considering technologies in order to achieve water quality standards. But, wet weather issues also need to be addressed. We will do our best to be cost effective and environmentally responsible.

Question/Comment: We currently have decades of data from California, yet will never have enough data.

Please do not continue to say that we lack enough data. Instead, take our collective knowledge and make conclusions carefully. Do not skew the data one way or the other.

Question/Comment: At the Expert Workshop, public health officials said that it was not feasible to make an economic argument for preventing SSOs. What is happening with the EA?

Response: EPA is looking to the report to inform policy decisions.

Human Health Impacts of CSOs and SSOs

Greg Frey – SRA International

Mr. Frey began by introducing the key questions addressed in this chapter:

- What constituents of CSOs and SSOs cause human health impacts?
- Of what consequence are these impacts?
- Which exposure pathways are the most significant and what populations are most sensitive?
- What are the impediments to understanding the linkages between CSOs and SSOs, exposures, and the human health impacts?
- What is the institutional framework to assess and address potential human health impacts of CSOs and SSOs?

Mr. Frey explained that EPA first performed an extensive literature review. Then, EPA held an experts workshop in order to verify the accuracy of data already collected, find new sources, and ascertain an understanding of experts' opinions of the human health impacts of CSOs and SSOs. EPA next performed a series of state and community interviews for the purpose of understanding local and state health agency staff's opinions of the impacts of CSOs and SSOs and to characterize the current activities being carried out that address this potential threat.

Mr. Frey went on to present the range of human health symptoms resulting from exposure to the pollutants typically found in CSOs and SSOs. Next, Mr. Frey discussed exposure pathways and the groups facing the most frequent exposure, as well as the groups most sensitive to waterborne illnesses.

Mr. Frey described the limitations of the major data sources used to identify and describe waterborne disease outbreaks, one potential indicator of human health impacts from CSOs and SSOs. He next presented local, site specific examples of outbreaks attributed to exposure to sewage in order to illustrate the potential for acute health impacts.

Next, EPA outlined the challenges to identifying the human health impacts of CSOs and SSOs. These include:

- The lack of connectivity in the monitoring and reporting systems for CSO and SSO events, human exposures, and human health impacts.
- The difficulty identifying the source of pathogens.
- The difficulty in attributing disease outbreaks to specific CSO and SSO events.
- The fact that outbreak reporting to CDC is voluntary.
- The understanding that many people who become ill do not seek medical treatment due to the nature of such illnesses.
- There are inconsistent probabilities of diagnoses within the health care system.
- The general tendency towards underreporting.

Conclusions for the Human Health Impacts Chapter

Finally, Mr. Frey identified the actions that are currently being taken by state and local governments to address the human health impacts from CSOs and SSOs and EPA's preliminary conclusions. These include:

- The pathogens and pollutants found in CSOs and SSOs have the potential to cause human health impacts.
- Exposures to the pathogens and pollutants resulting from CSOs and SSOs occur, but are difficult to quantify.
- Human health impacts from waterborne diseases are underreported.
- Responsibilities for protecting human health from waterborne illnesses are distributed among many agencies and institutions.

Stakeholder questions and comments on the Human Health Impacts Chapter

Questions and comments received after the human health presentation are summarized below. The comments represent stakeholder opinion(s) and may not reflect EPA's position.

- Regarding the Austin example, there are no CSOs in Austin, and since there is no source attribution, the slide on the predictive closings at Barton Springs makes the observer think that all the pathogens are due to CSOs or SSOs. Be careful which examples you use.
- Does EPA have data on bacterial concentrations in different effluents? If so, add it.
- In the slide that attempts to put the outbreaks of E. coli into perspective, shellfish pathways would be listed under foodborne, but actually may be exacerbated by an SSO or CSO issue.
- Why did EPA not include shellfish advisories for the Great Lakes?
- Remember to add specific information whenever possible.
- Some stakeholders questioned whether the Brushy Creek, Texas, incident was related to an SSO. Because it was caused by a power failure, they did not think it was a good example.
- Stakeholders debated how much disease and antibody production could be attributed to SSOs or CSOs (i.e., how many cases are from human sources).
- Was the Milwaukee outbreak due to a CSO? If so, please clarify.
- There is a Great Lakes Watershed pathogen source study underway, but it will not be completed in time to inform the Report to Congress.
- Stakeholders questioned the proportion of illness attributable to CSOs or SSOs and thought the presentation was misleading.
- Rather than stating that quantification of exposure is difficult, EPA should say why it is difficult. EPA has data about what is "coming out of the pipe" but needs to better understand receiving water characteristics.
- Regarding the responsibilities slide, there has been a 25-year lag between legislation and the production of a comprehensive communication system. Will EPA state who should take responsibility for this?
- Are the pathogen measurements from the sediment or do they just represent the water column concentrations?
- Why did EPA not include aerosols as a pathway?
- Some stakeholders said that there is no way to attribute a portion of mercury loadings to CSOs and SSOs.
- Has EPA found characteristics from the different agencies that lead to communication difficulties?
- How do our pathogen concentrations compare to concentrations internationally? Should we be concerned with migration if pathogen concentration and type is partially dependent on demographics?
- Make sure that EPA's findings are not biased. Everything presented in the report should be definitely attributed to CSOs and SSOs.
- How did EPA come up with those populations who are most frequently exposed to pathogens from CSOs and SSOs? It looks like the majority of illnesses are from drinking water.
- What about the risks to people who are exposed to mold after basement backups?
- Clarify difference between storm water and sewer overflows.
- There is potential to contract the SARS virus from CSOs that are contaminated with hospital waste.
- Include all state and community interviews in the Report to Congress, giving specific examples.
- There have been thousands of beach water samples that show CSOs are not a problem. Attainment issues are wet weather problems.

- Beach closures are based on a 24-hour time lag from the time the sample is collected. There have been 150-200 closures in Indiana and yet no one has reported sicknesses (despite this time lag); therefore, the indicators are wrong.
- Need to remove the fish advisories from PCBs and mercury since these constituents are not in CSOs and SSOs.
- Make a distinction between events occurring during dry weather and wet weather.
- Maybe drinking water monitoring and treatment should be improved, rather than spending on CSO and SSO controls.
- How would proper enforcement of the long-term surface drinking water rule address Cryptosporidium issues, especially since so much is attributable to animals?
- Two percent of beach closures are due to CSOs. This may mislead people, since CSOs are concentrated geographically and therefore the local impacts may be much more significant.
- The report should comment on the relative risks of human versus non-human bacteria.

Technologies for CSO and SSO Control

Kevin DeBell – Office of Wastewater Management, EPA

Mr. DeBell described the key data sources for the technology chapter. These included:

- Extensive literature reviews of existing EPA documentation as well as other sources;
- Interviews with municipal officials;
- Meetings with key EPA staff; and
- Informal peer review by internal and external experts.

Key Questions for the Technologies Chapter

Mr. DeBell introduced the key questions that were addressed:

- What technologies have been used by municipalities to control CSOs and SSOs?
- What factors influence the effectiveness of these technologies?
- Have there been any recent technological innovations in the control of CSOs and SSOs?

While researching this chapter, EPA identified common and promising technologies used by municipalities to address CSOs and SSOs. From this research, EPA developed technology descriptions summarizing available technologies and factors influencing their effectiveness. Mr. DeBell explained that it is very difficult to compare certain types of technologies, as they are designed to deal with different aspects of wet weather challenges. Therefore, the technologies were not ranked for effectiveness against each other within this chapter.

Presentation of Technologies

Mr. DeBell said that a wide range of technologies are available and that, within the report, they had been grouped into five key categories:

- Operations and maintenance activities;
- Collection system controls;
- Storage facilities;
- Treatment technologies; and
- Low impact development techniques.

Mr. DeBell mentioned that EPA developed case studies on each of the researched technologies, and presented preliminary findings pertaining to the relative cost of implementing the systems, the type of system for which the technology was designed, and the pollutants or problems controlled by the technology.

Stakeholder Questions and Comments on the Technologies Chapter

Questions and comments received after the technologies presentation are summarized below. The comments represent stakeholder opinion(s) and may not reflect EPA's position.

- This information is not useful from a policy perspective, as it does not evaluate the technologies. At least “tell the story” on a community basis. Things that should be included in these evaluations include volume, flow, constituents, what the community did to address the problem, results, etc.
- Available technologies are dependent on what EPA allows communities to use, so defining the technology type takes decisions out of municipalities' hands.
- How will the technology clearinghouse be managed?
- What about technologies used for satellite facilities?
- What about blending technologies?
- Most of the technologies were better suited to combined sewer systems. Stakeholders were concerned that SSO control was not looked at extensively enough.
- Some pollution prevention activities should be the responsibility of the individual and not the municipality, but municipalities still have to enforce the regulations and the ultimate responsibility is theirs.
- EPA needs to get more specific. This report needs a discussion of the effectiveness of technologies.
- EPA needs to add data on collateral damage from implementing technologies, for example, in- or off-line storage can lead to contamination of groundwater.

Resources Spent on CSO and SSO Control

Kevin DeBell – Office of Wastewater Management, EPA

Mr. DeBell outlined the methodological approach to this chapter which included:

- Data analysis which tabulated information of past investments in clean water infrastructure and compiled information on what has been spent on CSO and SSO control.
- EPA's estimate of the investment needed to meet the current requirements for CSO and SSO controls.
- EPA's acknowledgement of the fact that costs of CSO and SSO control are borne almost exclusively by local governments and utilities but local governments and utilities have not been requested to report the costs incurred for CSO and SSO control.

Stakeholder Questions and Comments on the Resources Chapter

Questions and comments received after the resources presentation are summarized below. The comments represent stakeholder opinion(s) and may not reflect EPA's position.

- EPA cited funding of \$9.1 billion in 1980 (in the presentation) – the stakeholder believed that Congress never appropriated more than \$2.4 billion through construction grants.
- All State Revolving Funds money has to be paid back, so these really are local expenditures, not federal.
- At least one community had money earmarked from the federal government. EPA needs to distinguish between local and federal expenditures.
- EPA should do an analysis of per capita costs.
- Stakeholders questioned the term “significant” with respect to past grant funding.
- Emphasize the need for grants to move things forward, especially for communities with small populations. Expanding grant money to small communities can result in huge benefits to water quality.
- The “knee of the curve” diagram is right on target. EPA needs to understand that it is not cost effective to eliminate all overflows. EPA should understand how the level of CSO control compares

to water quality – four overflows per year would be cost effective and we would have improved water quality (provided that we capture the first flush). See Akron Regional Sewer District for more “knee of the curve” information.

- Make sure to reflect what caused the environmental benefits. Is it CSO and SSO prevention or controls for other wet weather events?
- There are many agencies and organizations that have done financial analyses, including the Army Corps of Engineers
- The reference to EPA’s Gap Analysis is good. Stakeholders suggested that EPA include a summary of the Gap Analysis in this report.
- EPA should reference growing interest in a clean and safe water trust fund.
- Qualify the reference to 106 grants and how they contribute to CSO or SSO control.
- Community cost estimates are larger than in the Gap Analysis. Will both be reflected in the report?
- Distinguish between points of fact and policy suggestions.
- In the presentation, the Gap Analysis information was presented two different ways, make sure that this information is presented in such a way that it can be compared. Use a common denominator.
- All of the analysis is based on anecdotal evidence; there are no real data.
- Put numbers in the context of per capita flow and the time frame of the project.
- Estimates will be different if blending is allowed. EPA should indicate the difference in cost if blending is allowed.
- A goal of the CSO Control Policy was to move forward with realistic plans and make sure that they are economically sound.

Common Themes Heard During the Meeting

The following comments are paraphrases and summaries of actual stakeholder comments that emerged at many points throughout the meeting. They reflect recurring themes. Because the statements came from different stakeholders at the meeting, there are conflicts and disagreements among them. Additionally, all of the comments listed below are stakeholder opinion(s) and may not reflect EPA’s position.

Specific Policy and Program-Related Questions and Comments

- The report should help municipalities prioritize resources spent on CSOs and SSOs versus other wet weather events.
- The report should help Congress make more informed decisions about wet weather issues and other water quality issues as a whole, not just look at CSOs and SSOs in a vacuum.
- The report should help Congress prioritize funding for wet weather issues.
- The report states that there is a significant lag (25 years) between the development of water quality laws and the comprehensive communication system regarding detecting, reporting and tracking waterborne diseases related to water quality issues.
- Are data collected during the Report to Congress effort also being used to inform the SSO economic analysis?
- Enforcement of the Pretreatment Rule may reduce the human health risks associated with CSOs and SSOs, which include an industrial wastewater component. This was brought up with regard to hospital waste.
- Does EPA have an understanding of the total costs of all of the regulations that are coming?
- Are all wet weather events extreme events? What are acceptable levels of discharge?

Across the presentations, there were questions related to the completeness, accuracy, and representation of the information and data. While some of the comments are a product of the limited amount of information that can be conveyed in presentation format during a two-day meeting, they are all included here. All of the comments listed below are stakeholder opinion(s) and may not reflect EPA’s position.

- Make sure that the data EPA uses are as current, correct, and complete as possible. When a clear source of information is not apparent, feel free to provide Congress with conflicting data, but explain them.

- Make sure that data are unbiased in selection and presentation. On one hand, make sure that EPA does not lead the reader to draw unsupported conclusions of the negative impacts of CSOs and SSOs – avoid guilt by association. On the other hand, do not limit inclusion of information and data to national-scale, complete data sets. Local information and experience is valuable.
- Draw conclusions that are appropriate for the scale of the available data.
- Whenever possible, provide ranges in your data and interpretations in order to adequately describe the variability. All data should be transparent and the reader should be able to understand how EPA is using the data.
- Provide context to your information. For example, if the report states that something is 5 percent of something else, make sure that the overall universe is clear.
- Describe data in a manner that is useful to Congress, municipalities, and other stakeholders.
- Because the data are so variable and include so much anecdotal evidence, it is important to present it in a useful way. While there may not be enough information to completely inform policy decisions, there are conclusions that EPA should draw to help Congress, municipalities, and other stakeholders understand the data presented. One of the biggest findings of this report may be that we have a serious lack of data and an incomplete picture.

**Report To Congress
Stakeholder Meeting Attendee List**

Washington D.C.

June 24-25, 2003

Name, Office/Organization

Angela Akridge, Louisville & Jefferson County Metropolitan Sewer District
David Baron, Earthjustice
Benita Best-Wong, USEPA
Steve Bieber, Metropolitan Washington Council of Governments
Joe Boles, New Iberia (Louisiana) Municipal Government
Karl Boone, ADS Corporation
Linda Boornazian, USEPA
Walter Brodtman, USEPA
Jason Brooks, Knoxville Utilities Board
Ted Brown, Center for Watershed Protection of Ellicott City MD
Thomas Brueckner, Narragansett Bay Commission
Deb Caraco, Center for Watershed Protection of Ellicott City MD
Sharie Centilla, USEPA
Shellie Chard McClary, Oklahoma Department of Environmental Quality
John Chorlog, Miami-Dade County Water and Sewer Department
Victoria Cluck, Indianapolis Department of Public Works
Gary Cohen, Hall & Associates
Hubert Colas, BPR CSO
Anna Collery, Engineering Field Activities (EFA) Chesapeake
Lamont "Bud" Curtis, The TAF Group
Kimberly V. Davis, Hazen and Sawyer
Kevin DeBell, USEPA
Mike Domenica, Black & Veatch
Gary A. DuVal, City of Richmond Public Utilities
Janet Faulk, New Iberia (Louisiana) Municipal Government
Erin Flanagan, Rockefeller Family Fund
Ruth Fontenot, New Iberia (Louisiana) Municipal Government
Peter Fortin, City of Norfolk, VA
Tom Franza, San Francisco Public Utilities Commission
Greg Frey, SRA
Wil Garland, ADS Corporation
Heather Gewandter, SRA
Paul Greenfield, University of Queensland
Frank Greenland, Northeast Ohio Regional Sewer District
Ben Grumbles, USEPA
Ahmad Habibian, Ph.D., P.E., Black & Veatch Corporation
Art Hamid, MWH Americas, Inc.
Jim Hanlon, USEPA
Eric M. Harold, P.E., Buchanan Street Consulting
Marvin Hayes, Parsons
Jim Heist, CDS Technologies Inc.
Roy A. Herwig, Brown and Caldwell
John Hills, Irvine Ranch Water District
Bud Hixson, Friends of Beargrass Creek
Lisa E. Hollander, Northeast Ohio Regional Sewer District
Chris Hornback, AMSA
Carol Hufnagel, Tetra Tech
J. Leonard Ignatowski, P.E., EFA Chesapeake

Rick Karasiewicz, PBS&J
Rachel Katonak, Michigan State University
Ifty Khan, Wastewater Collection Division, DPWES
Don Killinger, Cuyahoga County Board of Health
Carol Kocheisen, National League of Cities
Fred Krieger
Jane Lavelle
Norman E. LeBlanc, Hampton Roads Sanitation District
Stewart T. Leeth, McGuireWoods LLP
Carol Leftwich, Environmental Council of the States
Roger Lemasters, Tennessee Department of Environment and Conservation
Federico Maisch, Greeley and Hansen LLC
Linda Manning, SRA
George L. Martin, Greenwood Metropolitan District
Bob Matthews, CDM, Inc
Michael J. McCabe, Milwaukee Metropolitan Sewerage District
Nate McConoughey, Cuyahoga County Board of Health
Jane McLamarrah, MWH
Heather McTavish, American Public Works Association
James B. Meyer, Meyer & Wyatt, P.C.
Sarah Meyland, Citizens Campaign for the Environment
Peter Moffa, Brown and Caldwell
Julia Moore, Limno-Tech, Inc.
John Murphy, P.E., City of Bangor
Gary Nault, United States Air Force
Sharon Nicklas
Paul Novak, U.S. Environmental Protection Agency, Ohio
Jan Oliver, Allegheny County Sanitary Authority (ALCOSAN)
Laurel O'Sullivan, Lake Michigan Federation
Betsy Otto, American Rivers
Karen L. Pallansch, Alexandria Sanitation Authority
Stacy Passero, P.E., Water Environment Federation
Tom Ripp, USEPA
J. Alan Roberson, P.E., American Water Works Association
Dr. Joan Rose, Michigan State University
Nelson Ross, Tennessee Izaak Walton League
Lesley Schaaff, U.S. Environmental Protection Agency
Nancy Schultz, CH2M
Eric Seaman, Department of Natural Resources
Michael J. Sharp, Sonny Callahan and Associates, LLC
Mohsin R. Siddique, DC Water and Sewer Authority
Nancy Stoner, Natural Resources Defense Council
Mike Sullivan, Limno-Tech, Inc.
Chris Swann, Center for Watershed Protection of Ellicott City MD
Rod Thornhill, White Rock Consultants
Peter Trick, SRA
Betsy Valente, Limno-Tech, Inc.
Tara Van Atta, SRA
Lynn Vendinello, EPA, Evaluation Support Division
Mark G. Wade, P.E., Wade & Associates, Inc.
Robert C. Weaver, Kelly & Weaver, P.C.
Neil Weinstein, The Low Impact Development Center, Inc.
Nancy Wheatley, Water Resources Strategies

Clyde Wilber, Greeley and Hansen LLC
Gus Willis, CDS Technologies Inc.
George Zukovs, XCG Consultants Ltd.

B.3. Stakeholder Meeting Summary, Huntington Beach, CA

2003 Report to Congress on the Impacts and Control of Combined Sewer Overflows and Sanitary Sewer Overflows

Stakeholder Meeting Summary Huntington, CA

On July 8, 2003, the U.S. Environmental Protection Agency held a meeting in Huntington Beach, California, at the Huntington Beach Public Library to discuss the upcoming Report to Congress on the impacts and control of CSOs and SSOs. The meeting provided an opportunity for EPA to present the results of the data collection, request verification of information and data sources, and solicit feedback on preliminary findings and interpretations.

The main goals of the meeting were to:

- Discuss the data, report methodology, and analyses for the 2003 Report to Congress;
- Discuss implications of the major analyses in the report; and
- Discuss participants' experiences in controlling impacts from CSOs and SSOs.

The summary below describes the presentations that outline the contents of the Report to Congress and the resulting discussions. The summary is organized into the following major sections which correspond to the meeting agenda:

- Welcome
- Goals and Agenda for the Meeting
- Background on the Report
- Characterization Presentation
- Environmental Impacts Presentation
- Human Health Presentation
- Resources Spent Addressing CSO and SSO Issues
- Technology Presentation
- Presentation of Stakeholder Comment and Question Themes

Welcome

Benita Best-Wong – Office of Wastewater Management, EPA

Ms. Best-Wong thanked the Orange County Sanitation District for alerting EPA to the region's interest in the Report to Congress. She mentioned that this meeting was the second of two – the first was held in Washington, D.C., the previous week. She next answered some of the questions that were repeatedly heard at the previous meeting but would not be covered during the presentations.

Ms. Best-Wong gave updates on the blending issue, the SSO Rule, and the Storm Water Phase II Rule.

Ms. Best-Wong next touched on the desire of Assistant Administrator for Water, Tracy Mehan, to ensure policy that facilitates a watershed approach. He would like EPA to focus on efficient ways of doing things and be aware of areas where EPA can help municipalities economize and make the best decisions possible. She went on to say that EPA hopes to focus on environmental outcomes, such as water quality and swimmer safety, and not outputs. She reminded the participants that the information gathered for this report forms a baseline and is something from which to work. EPA hopes that the report can be used not only to inform decision making but also for stakeholders to use as a resource.

Goals and Agenda for the Meeting

Linda Manning – Facilitator, SRA International

Ms. Manning began by setting “ground rules” for the meeting. The ground rules were as follows:

- Do not repeat points. This meeting is simply a way to collect perspectives and the number of times a comment was made will not be presented.
- Remember that participants are only being presented with representational data.
- Please provide us with additional information sources.
- Remember that this is the first effort to pull together all available information on this topic. The data are incomplete.

Background on the 2003 Report to Congress

Kevin DeBell – Office of Wastewater Management, EPA

Mr. DeBell presented the background to the 2003 Report to Congress. He started by mentioning the near-term EPA policies that directly led to the request for the 2003 Report to Congress. First, he described the 1994 National CSO Control Policy which formalized EPA’s management expectations for CSS communities. Next, a summary of the 2001 *Report to Congress – Implementation and Enforcement of the Combined Sewer Overflow Control Policy* was presented. This report acted as a program evaluation in which success of CSO Control Policy implementation was assessed; one useful product of the 2001 Report is the CSO database, which includes information on all CSO permits. Mr. DeBell then mentioned the draft SSO Notice of Proposed Rulemaking, and the 2000 Wet Weather Water Quality Act, which required the 2003 Report. The statutory requirements for the 2003 Report are stated below:

The Administrator of the Environmental Protection Agency shall transmit to Congress a report summarizing:

- a. the extent of human health and environmental impacts caused by municipal combined sewer overflows and sanitary sewer overflows, including the location of discharges causing such impacts, the volume of pollutants discharged, and the constituents discharged;*
- b. resources spent by municipalities to address these impacts; and*
- c. an evaluation of the technologies used by municipalities to address these impacts.*

Mr. DeBell next explained that EPA is not required to have a public review of reports to Congress, but that this particular program has a legacy of stakeholder collaboration, which EPA values.

Finally, Mr. DeBell acknowledged the research team and presented the report outline. The Report to Congress is organized as follows:

- Introduction
- Background
- Methodology
- Characteristics of CSOs and SSOs
- Environmental Impacts of CSOs and SSOs
- Human Health Impacts of CSOs and SSOs
- Federal and State Actions to Control CSOs and SSOs
- Technologies Used to Reduce the Impacts of CSOs and SSOs
- Findings and Recommendations

Stakeholder Questions and Comments on the Background Presentation

Questions and comments received after the background presentation are summarized below. The comments represent stakeholder opinion(s) and may not reflect EPA’s position.

- Is EPA taking this opportunity to weigh in on the blending rule?
- In the Wet Weather Water Quality Act of 2000, is there a context for larger wet weather events in the act language?

Characterization of CSOs and SSOs

Kevin DeBell – Office of Wastewater Management, EPA

Mr. DeBell presented data on the location of CSO and SSO discharges, the volume of pollutants discharged, the constituents discharged, and the frequency of discharge events.

This presentation defined a CSO as a mixture of untreated sewage and storm water discharged from a combined sewer system at a point prior to the headworks of the POTW. Generally, CSOs occur during wet weather when the CSS becomes overloaded. SSO is defined as a discharge of untreated or partially treated wastewater from a sanitary sewer system at any point prior to the headworks of a POTW. Backups of wastewater to private property are not included in the definition of SSO used for this Report to Congress.

Data Sources for the Characterization Chapter

EPA used the following data sources to characterize CSOs and SSOs.

- State databases for tracking CSO and SSO events;
- NPDES permit files;
- Approximately 80 interviews with state and municipal officials;
- LTCPs and other capital improvement documentation;
- Literature review; and
- Existing EPA documentation, including technical reports and products of cooperative agreements.

Key Research Questions for the Characterization Chapter

This presentation introduced three key research questions for the characterization chapter:

- How many NPDES permits exist for combined sewer systems and sanitary sewer systems?
- What are the common pollutants found in CSOs and SSOs?
- What are the volume, frequency, and location of CSOs and SSOs?

Stakeholder Questions and Comments for the Characterization Chapter

A list presenting the questions and comments received after the characterization presentation are summarized below. The comments represent stakeholder opinion(s) and may not reflect EPA's position.

- The term “basement backup” is misleading. EPA should replace it with “private property” backup, as many areas of the county do not have basements. The critical link in this phenomenon is the laterals. Private citizens do not know how to clean the laterals and plumbers do not report the problem.
- EPA needs to highlight the lack of consistency between different jurisdictions. There is no baseline for SSO reporting. It is important to let Congress understand that this information is missing.
- Look at WERF reports for other estimates on pollutant concentrations and other CSO/SSO characteristics.
- Differentiate between major and minor sources.
- Make sure to assess benefits versus the costs of elimination, so that we know where we can best put our resources to help the environment.
- Can the federal government fund this collection system program like they did for secondary treatment? Municipalities cannot do it.
- Stakeholders commented that communities had SSO tracking systems.

- How were sewer systems rated in the report? Some stakeholders wanted to know if they would be able to see how their system compared to a national average.
- Characterize SSO by volume per 100 miles of pipe in order to compare systems.
- Present SSO events by cause. EPA may also want to break out events regionally. Doing this will help identify extreme weather events.
- SSO should only be defined based on what agencies are responsible for (i.e., agencies are not responsible for all laterals).
- It will be very difficult to compare systems nationally, due to the differences in reporting requirements.
- In the slides, how do the volume and frequencies of SSOs compare to the amount of sewage collected?
- Is EPA distinguishing between the SSO effluent that actually gets to surface water versus how much is collected and disposed of properly?
- Does EPA have details about how many of the SSOs in the database were due to wet weather and I/I?
- It is not possible to design sewers based on every potential storm event. The report should address what can not be contained in the system.
- The conclusion “On a local scale, pollutant loads from CSOs and SSOs can be significant”—the opposite can also be true. On a local scale, pollutant loads may not have significant impacts.
- Regarding reporting thresholds, maybe there is a reason for thresholds, the report should discuss the rationale.
- Excluded from the study is storm water, but a significant source of pathogens found in storm water are from SSOs.
- Need to understand the water quality issues in receiving waters.
- In the SSO database, has EPA identified repeated, chronic, or preventable spills? Sewage collection agencies are responsible for these incidents and they need to correct them. This type of spill may skew or misrepresent the real problem.
- EPA could describe money spent versus pipe miles versus spills to compare communities.
- What percent of the spills reach receiving waters? A stakeholder said that during wet weather, very little of the amount spilled was contained, but during dry weather most was contained.
- Stakeholders mentioned that flood control systems are designed to withstand 195-year floods but there are no standards for sewer systems.
- Stakeholders said that the report needed to focus on impacts and focus on specifics.

Environmental Impacts of CSOs and SSOs

Hans Holmberg – Limno-Tech, Inc.

Mr. Holmberg began by defining “environmental impacts” as water quality, aquatic life, and aesthetic impacts that affect designated uses. Violations of water quality standards were used as an indicator for environmental impacts. While researching this chapter, EPA used previously completed national, state, and local assessments. Literature and web searches were performed and interviews with state and municipal officials were carried out.

EPA sought to characterize types of environmental impacts from CSOs and SSOs. First, EPA presented ranges in concentrations of the constituents typically found in CSOs and SSOs. EPA presented the results of assessments of environmental impacts caused by CSOs and SSOs. They acknowledged that while beach closures and shellfish bed closures have been traced to CSOs and SSOs, the data are not complete.

EPA described planned national assessments in which CSO outfall locations will be integrated with EPA’s WATERS database. This will allow CSO locations to be associated with information such as 303(d) impaired reaches and drinking water intakes.

Conclusions for the Environmental Impacts Chapter

EPA presented preliminary conclusions regarding the environmental impacts from CSOs and SSOs. These included:

- CSOs and SSOs contain pollutants that cause impairments to designated uses, as reported in national assessments.
- CSOs and SSOs can be a principal cause or a contributing cause of an environmental impact.
- National data are inconsistent in tracking CSOs and SSOs as a direct cause of impairment.
- While data are not comprehensive, some national estimates of use impairment have been made.
- State and local examples of cause and effect exist where CSO and SSO reporting and tracking are undertaken.

EPA asked the stakeholders present at the meeting for additional information on documented environmental impacts from CSOs and SSOs.

Stakeholder Questions and Comments on the Environmental Impacts Chapter

Questions and comments received after the environmental impacts presentation are summarized below. The comments represent stakeholder opinion(s) and may not reflect EPA's position.

- Most impacts seem very locally specific.
- Because of the ambiguity of the data, should you split them into separate categories in order to direct policy talks and funding allocations?
- There may be a time lapse between the event and the environmental impact. Does the report measure that?
- The beach closure chart should clarify miles by including the total miles of beach.
- Is EPA saying that municipal point sources, specifically CSOs and SSOs, are leading sources of water quality impairment?
- Stakeholders said that within their jurisdictions, a significant amount of water contamination is due to failing septic tanks.
- Stakeholders thought that EPA should try to gain an understanding of the concentration of pathogens from SSO to storm water, which leads to beach closing.
- Distinguish between beach advisories, which (in California) are based on bacteria levels from ongoing water quality monitoring, and beach closures, which (in California) happen after every reported SSO/CSO event.
- For SSO, EPA cannot blame natural phenomenon, such as rain and snowmelt, for overflows.

Human Health Impacts of CSOs and SSOs

Heather Gewandter – SRA International

Ms. Gewandter began by introducing the key questions addressed in this chapter:

- What constituents of CSOs and SSOs cause human health impacts?
Of what consequence are these impacts?
- Which exposure pathways are the most significant and what populations are most sensitive?
- What are the impediments to understanding the linkages between CSOs and SSOs, exposures, and the human health impacts?
- What is the institutional framework to assess and address potential human health impacts of CSOs and SSOs?

Ms. Gewandter explained that EPA first performed an extensive literature review. Then, EPA held an experts workshop in order to verify the accuracy of data already collected, find new sources, and ascertain an understanding of experts' opinions of the human health impacts of CSOs and SSOs. EPA next performed a series of state and community interviews for the purpose of understanding local and state health agency staff's opinions of the impacts of CSOs and SSOs and to characterize the current activities being carried out that address this potential threat.

Ms. Gewandter went on to present the range of human health symptoms resulting from exposure to the pollutants typically found in CSOs and SSOs. Next, she discussed exposure pathways and the groups facing the most frequent exposure, as well as the groups most sensitive to waterborne illnesses.

Ms. Gewandter described the limitations of the major data sources used to identify and describe waterborne disease outbreaks, one potential indicator of human health impacts from CSOs and SSOs. She next presented local, site specific examples outbreaks attributed to exposure to sewage in order to illustrate the potential for acute health impacts.

Next, EPA outlined the challenges to identifying the human health impacts of CSOs and SSOs. These include:

- The lack of connectivity in the monitoring and reporting systems for CSO and SSO events, human exposures, and human health impacts.
- Difficulty identifying the source of pathogens.
- The difficulty in attributing disease outbreaks to CSO and SSO events.
- The fact that outbreak reporting to CDC is voluntary.
- The understanding that many people who become ill do not seek medical treatment due to the nature of the illness.
- There are inconsistent probabilities of diagnoses within the health care system.
- The general tendency towards underreporting.

Conclusions for the Human Health Impacts Chapter

Finally, Ms. Gewandter identified the actions that are currently being taken by state and local governments to address the human health impacts from CSOs and SSOs and EPA's preliminary conclusions. These conclusions include:

- The pathogens and pollutants found in CSOs and SSOs have the potential to cause human health impacts.
- Exposures to the pathogens and pollutants resulting from CSOs and SSOs occur, but are difficult to quantify.
- Human health impacts from waterborne diseases are underreported.
- Responsibilities for protecting human health from waterborne illnesses are distributed among many agencies and institutions.

Stakeholder Questions and Comments on the Human Health Impacts Chapter

Questions and comments received after the human health impacts presentation are summarized below. The comments represent stakeholder opinion(s) and may not reflect EPA's position.

- Comment on warnings: In California, in event of SSO, beaches close immediately and there is no lag time.
- Clarify between postings, advisories, and closures.

- CDC released a paper in 1999 that said there were 300 cases of Cryptosporidiosis annually. This is contradictory to the information EPA presented and shows that there is a lot of uncertainty.
- The information regarding sensitive populations is all speculation.
- EPA needs to distinguish between large and small potential exposures; break out one-time exposure risk (metals) versus chronic exposures.
- There are no criteria for metals for recreational use.
- Just because a person has Cryptosporidiosis does not mean they get sick.
- Did EPA coordinate with the new epidemiology studies?
- Did EPA do risk assessment with pathogen data? Has EPA put the risk (of health impacts from CSO and SSO) in context with other risks?
- Did the literature review find epidemiological studies on WWTP workers? Did they build immunity?
- The material is inconclusive.
- Tie in anticipated exposure levels.
- Make sure to qualify that the pathogens and pollutants are coming from human waste and wastewater in the table.
- If groundwater impacts are a concern, many parameters are attenuated.

Resources Spent on CSO and SSO Control

Kevin DeBell – Office of Wastewater Management, EPA

Mr. DeBell outlined the methodological approach to this chapter which included:

- Data analysis which tabulated information of past investments in clean water infrastructure and compiled information on what has been spent on CSO and SSO control.
- EPA's estimate of the investment needed to meet the current requirements for CSO and SSO controls.
- EPA's acknowledgement of the fact that costs of CSO and SSO control are borne almost exclusively by local governments and utilities but local governments and utilities have not been requested to report the costs incurred for CSO and SSO control.

Stakeholder Questions and Comments on the Resources Chapter

Questions and comments received after the resources presentation are summarized below. The comments represent stakeholder opinion(s) and may not reflect EPA's position.

- Are SSO control expenditure needs distinguished from overall needs?
- Is the cost EPA has designated as SSO cost incremental or is it the total cost of running the sewage collection system? Since all money spent on the sewage collection system is aimed at getting sewage to the plant and preventing sewage spills, the total number may be more accurate.
- Do you plan to use other financial studies besides EPA's Gap Analysis (i.e., Waste Infrastructure (WIN) report)? The two studies have contradictory findings and a stakeholder did not want Congress to be confused if it heard the findings from the WIN report and they were not mentioned in this report.
- Stakeholders were concerned about private spills. Since municipalities do not pay for those, some stakeholders did not want them included, or they wanted these estimates to at least be called out.

Technologies for CSO and SSO Control

Kevin DeBell – Office of Wastewater Management, EPA

Mr. DeBell described the key data sources for the technology chapter. These included:

- Extensive literature reviews of existing EPA documentation as well as other sources;
- Interviews with municipal officials;

- Meetings with key EPA staff; and
- Informal peer review by internal and external experts.

Key Questions for the Technologies Chapter

Mr. DeBell introduced the key questions that were addressed:

- What technologies have been used by municipalities to control CSOs and SSOs?
- What factors influence the effectiveness of these technologies?
- Have there been any recent technological innovations in the control of CSOs and SSOs?

While researching this chapter, EPA identified common and promising technologies used by municipalities to address CSOs and SSOs. From this research, EPA developed technology descriptions summarizing available technologies and factors influencing their effectiveness. Mr. DeBell explained that it is very difficult to compare certain types of technologies, as they are designed to deal with different aspects of wet weather challenges. Therefore, the technologies were not ranked for effectiveness against each other within this chapter.

Presentation of Technologies

Mr. DeBell said that a wide range of technologies are available and that, within the report, they had been grouped into five key categories:

- Operations and maintenance activities;
- Collection system controls;
- Storage facilities;
- Treatment technologies; and
- Low impact development techniques.

Mr. DeBell mentioned that EPA developed case studies on each of the researched technologies and presented preliminary findings pertaining to the relative cost of implementing the systems, the type of system for which the technology was designed, and the pollutants or problems controlled.

Stakeholder Questions and Comments on the Technologies Chapter

Questions and comments received after the technologies presentation are summarized below. The comments represent stakeholder opinion(s) and may not reflect EPA's position.

- There is a lack of innovative technologies investigated, especially the decentralized technologies.
- Did EPA discuss odor control?
- What about the fats, oils, and grease requirements, will they be included in the SSO rule?
- Do you have any understanding about the total cost of all of the regulations that are coming?

**Report To Congress
Stakeholder Meeting Attendee List**

Huntington Beach, CA

July 8, 2003

Name, Office/Organization

Andy Aguilar, Surfrider Foundation
Richard Alcorn, City of Rancho Cucamonga
Jody Allen, Sacramento County
Ric Amador, City of San Diego
Rodney Andersen, City of Burbank
Nick Arhontes, Orange County Sanitation Districts
Daniel Askenaizer, MWH
Regan Bailey, City of Riverside
Dennis Baker, Earth Resource Foundation
Richard Bardin, Boyle Engineering Corporation
Danilo Batson, City of Glendale
Cindy Beck, Irvine Ranch Water District
Matthew Bequette, City of Los Angeles
Benita Best-Wong, USEPA
Thomas Blanda, Orange County Sanitation Districts
M. Todd Broussard, City of Huntington Beach
Bryan Brown, City of Los Angeles
Ray Burk, City of Santa Ana
Ed Burt, City of Newport Beach
John Butcher, NCPI
Olson Childress, City of Chino Hills
Marvin Chiong, Los Angeles County Department of Public Works
James Clark, Black & Veatch
Daniel Cooper, Lawyers for Clean Water
Lee Cory, Yorba Linda Water District
Kevin DeBell, USEPA
Jim Delicce, City of Newport Beach
Bill Denhart, City of San Diego
Parivash Dezhnam, Inland Empire Utilities Agency
Dick Dietmeier, South Coast Water District
Rick Donahue, City of San Diego
Mike Dunbar, South Coast Water District
Bill Echols, Central Contra Costa County Sanitary District
Michele Farmer, Orange County Sanitation Districts
Tom Fauth, Costa Mesa Sanitary District
Michael Feroz, Jacobs Civil Inc.
Ken Fischer, City of Burbank
Michael Flores, HDR
Paul Forsthoefel, ADS Environmental Services
Phil Friess, LACSD
Kevin Gensler, City of San Diego
Heather Gewandter, SRA
Marco Gonzalez, Surfrider Foundation
Chris Gray, City of Huntington Beach
Don Greek, DGA Consultants
Ken Greenberg, U.S. EPA, Region 9
Paul Guzman, Costa Mesa Sanitary District

Roy Hafar, City of Folsom
Roger Ham, Union Sanitary District
Robin Hamers, Costa Mesa Sanitary District
Daniel Hardgrove, City of Glendale
Alan Harrell, Coachella Valley Water District
F. Patrick Hassey, Sacramento County
Jonathan Hasson, ADS Environmental Services
Brent Hayes, Garden Grove Sanitary District
Jeannie Heimberger, City of Fountain Valley
Penny Hill, Los Angeles County Sanitation Districts
Hans Holmberg, Limno-Tech, Inc.
Larry Honeybourne, County of Orange
Lisa Marie Kay, MEC Analytical Systems Inc.
Zeki Kayiran, AKM Consulting Engineers
Bill Knitz, DGA Consultants
Ruth Kolb, City of San Diego
Bob Kreg, Southern California Alliance of Publicly Owned Treatment Plants
Patty Lambaren, City of Fullerton
Winnie Lee, PBS&J
Sylvie Lee, Inland Empire Utilities Agency
Albert Lee, Jr., City of Glendale
Keith Linker, City of Anaheim
Russell Maguire, City of Anaheim
Linda Manning, SRA
Lisa Mattered, City of Orange
Ziad Mazboudi, City of San Juan Capistrano
Monica Mazur, County of Orange
Joe McDivitt, South Coast Water District
Charles McGee, Orange County Sanitation Districts
Patrick McNelly, Orange County Sanitation Districts
Dayna Michaelsen, Midway City Sanitary District
Victor Moraga, City of Ontario
Andy Morrison, Union Sanitary District
Margie Nellor, Sanitation Districts of Los Angeles County
Bryan Ortega, City of Glendale
Ralph Palomares, El Toro Water District
Diann Pay, AKM Consulting Engineers
Ken Payne, City of Folsom
John Perry, City of San Bernardino
Michele Pla, CH2M Hill
Denis Pollock, MGD Technologies Inc.
Craig Proctor, Inland Empire Utilities Agency
Lloyd Prosser, EMA
Ronn Rathbun, City of Huntington Beach
Robert Reid, West Valley Sanitation District
Don Rhoads, Central Contra Costa County Sanitary District
Kenny Robbins, Midway City Sanitary District
Manuel Romero, City of Santa Barbara
Dick Runge, South Coast Water District
Jeff Sadler, ECA
Dale Schindler, Crestline Sanitation District
Kathy Schindler, Crestline Sanitation District

Don Schulz, Surfrider Foundation
John Shaffer, Environmental Engineering & Consulting
David Shissler, City of Laguna Beach
Mike Shope, Camp Pendleton
Gary Skipper, MGD Technologies Inc.
Mary Snyder, County of Sacramento
Stan Steinbach, Environmental Engineering & Consulting
Ken Theisen, California Regional Water Quality Control Board
Leo Truttmann, LTEC
Roger Turner
Tara Van Atta, SRA
Clarence Van Corbach, City of Manhattan Beach
Gonzalo Vazquez, City of Cypress
Konya Vivanti, Garden Grove Sanitary District
Jeff Walker, City of Chino Hills
Dan Wall, City of Burbank
Stephanie Warren, Surfrider Foundation
Jason Wen, City of Downey
Dave Williams, East Bay Municipal Utility District
James Wilson, City of Fresno
Rick Wilson, Surfrider Foundation
Hu Yi, Los Angeles County

Appendix C

Documentation of State and
Municipal Interviews

Documentation of State and Municipal Interviews

Data collection for this report involved a series of site visits and telephone interviews. Such data collection efforts were conducted in accordance with an Information Collection Request (ICR 2063.01), which was approved by OMB on September 16, 2002 (OMB No. 2040-0248).

Site Visits

EPA conducted site visits to seven states to obtain specific information regarding CSOs and SSOs for the report. The states visited include Connecticut, Kansas, Maryland, Missouri, North Carolina (SSO only), Oklahoma (SSO only), and Rhode Island. While there, EPA met with permitting staff to discuss programmatic issues related to CSO and SSO discharges. EPA also accessed the NPDES authority's electronic data management system for SSOs, where available.

North Carolina was specifically visited to obtain information on its collection system permitting program. Oklahoma was selected for a site visit to collect information on the state's collection system program used to address SSOs and other sewer system issues. The five states with both CSSs and SSSs— Connecticut, Kansas, Maryland, Missouri, and Rhode Island— were selected for site visits, because CSO permit file reviews were not conducted in these states for the *2001 Report to Congress—Implementation and Enforcement of the CSO Control Policy* (EPA 2001). The information gathered from these states was used to update the inventory of CSO outfalls, documented in Appendix D of this report.

EPA also conducted site visits to regional offices, municipal governments, sewer utilities and non-governmental organizations. EPA visited EPA Region 4 offices in Atlanta, GA, to collect pertinent information about the region's Management, Operation and Maintenance (MOM) program, and to review program files. EPA conducted site visits to Orange County and San Francisco, California. In Orange County, EPA met with the Orange County Sanitation District to gather SSO information and met with the Orange County Health Care Agency to collect beach monitoring data (including beach closings and postings). In San Francisco, EPA met with the San Francisco Public Utilities Commission to discuss CSO and environmental impact data. Moreover, EPA met with *Save the Bay* in Rhode Island and *Heal the Bay* in the greater Los Angeles-area to collect CSO and SSO-related information.

Public Health State and Municipal Phone Interviews

EPA also conducted interviews with public health personnel. State or territorial epidemiologists and local public health officials were the primary sources of data. During these interviews, EPA gathered data on pathogen sources, contaminated water exposures, and illness tracking. In addition, EPA inquired about innovative local programs in place to monitor CSOs or SSOs and/or waterborne illnesses. Through these interviews, EPA sought a clearer understanding of the roles and responsibilities of these agencies in preventing, tracking, and monitoring potential human health impacts associated with CSO and SSO discharges within their jurisdiction.

States and communities were selected from each EPA region in an attempt to ensure geographic, climatic, and population variability among communities interviewed. Nevertheless, the sample was intentionally biased, targeting communities that were likely to have health data related to CSOs and SSOs, or which employed noteworthy water quality monitoring or waterborne disease outbreak tracking techniques. In total, officials from even states and 23 municipalities, as shown in Appendix I, were interviewed.

CSO and SSO Municipal Telephone Interviews

In order to gather representative information to characterize CSOs and SSOs, EPA interviewed officials with 85 sewer agencies, 40 with CSSs and 45 with SSSs, which varied widely in terms of service area, population served, and sewer age. For example, EPA interviewed officials representing systems that served as few as 75 people to systems that served over one million people. In total, EPA interviewed municipal officials in 27 states by telephone. In some states, both CSO and SSO interviews were conducted. State NPDES authorities were contacted in advance of any interviews conducted within their states. At that time, EPA briefly interviewed state officials to gather information about environmental and human health impacts as well as cost information relevant to CSO and SSO discharges.

Potential CSO and SSO interviewees was selected as follows. For the CSO interviews, a list of CSO permittees that had developed and/or implemented CSO controls were extracted from the inventory of CSO permits (Appendix D). A list of unique entities with SSSs, which have reported at least one SSO, was extracted from the SSO data management system described in Appendix G. SSO communities studied in EPA fact sheets (EPA 2003) were excluded from consideration. A random sampling was taken from the CSO and SSO lists to create the pool of potential interviews. Municipal officials unable or unwilling to participate in the survey were replaced with alternate candidates.

Through the CSO interviews, EPA gathered information about collection systems, treatment plants (if applicable), operational responsibility, CSO events, environmental and human health impacts from CSO discharges, LTCP implementation, and funding. As part of the SSO interviews, EPA collected information about collection systems, treatment plants (if applicable), operational responsibility, SSO events, environmental and human health impacts from SSO discharges, O&M, and funding.

References

EPA. 2003. Office of Water. "Featured Factsheets, Case Studies, and Other Information." Retrieved October 3, 2003. <http://cfpub2.epa.gov/npdes/sso/featuredinfo.cf>.

EPA. 2001. Office of Water. *Report to Congress- Implementation and Enforcement of the Combined Sewer Overflow Control Policy*. EPA 833-R-01-003.

Appendix D

List of Active CSO Permits

List of Active CSO Permits, Sorted by Region and State

EPA Region	State	NPDES Permit Number	Facility Name	Number of Outfalls
1	CT	CT0100056	Bridgeport-West WPCF	32
1	CT	CT0100251	Hartford MDC WPCF	44
1	CT	CT0100366	New Haven East Shore WPCF	19
1	CT	CT0100412	Norwich WPCF	15
1	CT	CT0101010	Bridgeport-East WPCF	12
1	MA	MA0102997	Worcester Combined Overflow Facility	1
1	MA	MA0101168	Palmer WPCF	6
1	MA	MA0101192	Boston Water and Sewer Commission	37
1	MA	MA0101338	Town of Ludlow CSOs	1
1	MA	MA0101621	Haverhill WWTF	21
1	MA	MA0101877	Chelsea	4
1	MA	MA0101974	City of Cambridge	11
1	MA	MA0100986	Fitchburg WWTF	27
1	MA	MA0102351	MWRA, Deer Island WWTP	14
1	MA	MA0101508	Chicopee WPCF	31
1	MA	MA0103331	Springfield CSOs	25
1	MA	MA0101982	Somerville DPW	2
1	MA	MA0100455	South Hadley WWT	3
1	MA	MA0101630	Holyoke WPCF	15
1	MA	MA0100897	Taunton WWTPs	1
1	MA	MA0100137	Montague WPCF	2
1	MA	MA0100382	Fall River WWTP	19
1	MA	MA0100447	Greater Lawrence Sanitary District	5
1	MA	MA0100552	Lynn WWTF	4
1	MA	MA0100625	Gloucester WPCF	5
1	MA	MA0100633	Lowell Regional WWU	9
1	MA	MA0100781	New Bedford WWTF	35
1	ME	ME0100625	Skowhegan WPCP	9
1	ME	ME0100633	City of South Portland	8
1	ME	ME0102369	Fort Kent Utility District	1
1	ME	ME0100617	Sanford Sewerage District	2
1	ME	ME0100951	Paris WWTP	1
1	ME	ME0100781	Bangor WWTP	12
1	ME	ME0100846	Westbrook/Portland Water District	5
1	ME	ME0100854	Kennebec Sanitary District	3
1	ME	ME0100722	Winslow Sanitary District	2
1	ME	ME0101117	Saco WWTP	5
1	ME	ME0101214	Bar Harbor WWTF	3
1	ME	ME0101478	Lewiston-Auburn WPCA	1
1	ME	ME0101494	Fairfield	2
1	ME	ME0101681	Madawaska PCF	2
1	ME	ME0102075	Portland Water District	23
1	ME	ME0100595	Rockland WWTF	4
1	ME	ME0101702	City of Gardiner	2
1	ME	ME0100897	Hamden	1
1	ME	ME0101532	Belfast WWTF	2
1	ME	ME0100153	Corrina Sewer District	1
1	ME	ME0102466	Bar Harbor Hulls Cove	1
1	ME	MEU508074	Randolf	1
1	ME	ME0101435	City of Portland	12
1	ME	ME0100005	Auburn Sewerage District	6
1	ME	ME0100013	Augusta Sanitary District	24
1	ME	ME0100021	Bath WWTP	4

EPA Region	State	NPDES Permit Number	Facility Name	Number of Outfalls
1	ME	ME0100048	Biddeford Wastewater Department	11
1	ME	ME0100072	City of Brewer	7
1	ME	ME0100501	Town of Dover-Foxcroft Wastewater Department	4
1	ME	ME0100994	Lewiston	30
1	ME	ME0100196	Town of East Millinocket	1
1	ME	ME0100285	Town of Kittery	3
1	ME	ME0100307	Lisbon WWTF	2
1	ME	ME0100323	Machias WWTP	2
1	ME	ME0100391	Mechanic Falls Sanitary District	1
1	ME	ME0100439	Milo Water District	3
1	ME	ME0100471	Old Town PCF	3
1	ME	ME0100498	Orono Water Pollution Control Facility	1
1	ME	ME0100111	Bucksport WWTF	2
1	NH	NH0100234	City of Portsmouth	2
1	NH	NH0100366	City of Lebanon WWTF	6
1	NH	NH0100871	Exeter	1
1	NH	NH0100170	Nashua WWTF	8
1	NH	NH0100013	Berlin PCF	1
1	NH	NH0100447	City of Manchester WWTF	22
1	RI	RI0100072	Narragansett Bay - Bucklin	28
1	RI	RI0100315	Narragansett Bay - Fields Point	45
1	RI	RI0100293	Newport City Hall	3
1	VT	VT0100153	Burlington Main WWTF	1
1	VT	VT0100196	Montpelier WWTF	15
1	VT	VT0100285	Randolph WWTF	3
1	VT	VT0100374	Springfield WWTF	21
1	VT	VT0100404	Vergennes WWTF	0
1	VT	VT0100579	St. Johnsbury WWTF	19
1	VT	VT0100871	Rutland WWTP	3
2	NJ	NJ0108731	City of Rahway	0
2	NJ	NJ0108766	City of Hackensack	2
2	NJ	NJ0021016	Passaic Valley Sewerage Commissioners	0
2	NJ	NJ0111244	Town of Kearny	10
2	NJ	NJ0108782	City of Elizabeth	33
2	NJ	NJ0109118	Ridgefield Park Village	6
2	NJ	NJ0108791	Camden County MUA	1
2	NJ	NJ0108812	City of Camden	31
2	NJ	NJ0108847	Gloucester City	7
2	NJ	NJ0108871	Town of Harrison	7
2	NJ	NJ0108880	City of Paterson	31
2	NJ	NJ0108723	Jersey City MUA	27
2	NJ	NJ0108758	Newark	27
2	NJ	NJ0025321	North Hudson SA-West NY (River Road)	2
2	NJ	NJ0109240	City of Bayonne CSOs	28
2	NJ	NJ0117846	East Newark	1
2	NJ	NJ0020028	Bergen County WWTP Utilities Authority	0
2	NJ	NJ0020141	Middlesex County Utility Authority	0
2	NJ	NJ0020141a	Perth Amboy	16
2	NJ	NJ0020591	Edgewater MUA	0
2	NJ	NJ0024741	Joint Meeting of Essex & Union Counties	0
2	NJ	NJ0024643	Rahway Valley Sewerage Authority	0
2	NJ	NJ0108715	Guttenberg Town	1

EPA Region	State	NPDES Permit Number	Facility Name	Number of Outfalls
2	NJ	NJ0026085	North Hudson SA-Hoboken (Adams Street)	11
2	NJ	NJ0026182	Camden County MUA	1
2	NJ	NJ0029084	North Bergen MUA (Woodcliff)	1
2	NJ	NJ0034339	North Bergen MUA (Central)	0
2	NJ	NJ0034517	Fort Lee	2
2	NJ	NJ0108707	Passaic Valley Sewerage Commissioners	0
2	NJ	NJ0020923	Trenton Sewer Utilities Authority	1
2	NJ	NJ0108898	North Bergen MUA (Central)	9
2	NY	NY0027081	Syracuse Metro WWTP	62
2	NY	NY0029114	City of Oswego, East Side STP	6
2	NY	NY0029106	Oswego-West Side STP	1
2	NY	NY0029050	Glens Falls WWTP	1
2	NY	NY0028410	Bird Island WWTF	58
2	NY	NY0028339	Frank E. VanLare STP	6
2	NY	NY0027961	Dunkirk WWTP	1
2	NY	NY0248941	City of Mechanicville CSO	3
2	NY	NY0027545	Clayton Village WTF	2
2	NY	NY0029807	Canastota WPCF	1
2	NY	NY0027073	Red Hook WPCP	34
2	NY	NY0027057	Lockport WWTP	30
2	NY	NY0026689	Yonkers Joint WWTP	26
2	NY	NY0026336	Niagara Falls WWTP	9
2	NY	NY0026310	Newburgh WPCP	12
2	NY	NY0027766	Lewiston Master S.D.	1
2	NY	NY0031208	Dock Street STP	0
2	NY	NY0183695	Washington County S.D. 2	11
2	NY	NY0099309	Troy CSO	49
2	NY	NY0087971	Rensselaer County	0
2	NY	NY0036706	Ticonderoga S.D. #5 WPCP	2
2	NY	NY0035742	Chemung County-Elmira S.D. STP	11
2	NY	NY0033545	Village of Coxsackie STP	3
2	NY	NY0029173	Waterford WWTP	4
2	NY	NY0031429	Utica CSO	82
2	NY	NY0029351	Kingston WWTF	7
2	NY	NY0031194	Massena WWTP	10
2	NY	NY0031046	Cohoes CSO	16
2	NY	NY0030899	Watervliet CSO	5
2	NY	NY0029939	Tupper Lake WPCP	3
2	NY	NY0029831	Ogdensburg WWTP	17
2	NY	NY0026247	North River WPCF	50
2	NY	NY0033031	Green Island CSO	3
2	NY	NY0020818	Potsdam WPCP	1
2	NY	NY0026280	North Tonawanda WWTP	13
2	NY	NY0023981	Village of Johnson City CSO	2
2	NY	NY0023256	Village of Holley STP	0
2	NY	NY0022403	Little Falls WWTP	3
2	NY	NY0022136	Erie County S.D. #6	1
2	NY	NY0022039	Hudson STP	10
2	NY	NY0024481	Lewiston ORF	1
2	NY	NY0021873	Medina WWTP	13
2	NY	NY0025747	Albany CSO	12
2	NY	NY0020621	Wellsville WWTP	3

EPA Region	State	NPDES Permit Number	Facility Name	Number of Outfalls
2	NY	NY0020516	Schenectady WPCP	2
2	NY	NY0020494	Boonville WWTP	1
2	NY	NY0020389	Catskill WWTP	6
2	NY	NY0020290	Amsterdam WWTP	3
2	NY	NY0020117	Gouverneur STP	1
2	NY	NY0021903	Auburn STP	9
2	NY	NY0026131	Wards Island WPCP	78
2	NY	NY0026239	Tallmans Island WPCP	21
2	NY	NY0026221	NYCDEP Rockaway WWTP	27
2	NY	NY0026204	Newtown Creek WPCP	85
2	NY	NY0026191	NYCDEP-Hunt's Point WPCP	42
2	NY	NY0026182	NYCDEP Coney Island WPCP	4
2	NY	NY0026174	NYCDEP Oakwood Beach WPCP	1
2	NY	NY0024406	Binghamton CSO	10
2	NY	NY0026158	NYCDEP Bowery Bay WPCP	49
2	NY	NY0026255	Poughkeepsie WPCP	6
2	NY	NY0026115	NYCDEP Jamaica WPCP	6
2	NY	NY0026107	Port Richmond WPCF	36
2	NY	NY0026026	Rensselaer CSO	8
2	NY	NY0026018	Plattsburgh WPCP	14
2	NY	NY0025984	Watertown WPCP	17
2	NY	NY0025780	Oneida County WPCP	1
2	NY	NY0026166	NYCDEP Owls Head WPCP	16
2	NY	NY0026212	NYCDEP 26th Ward	4
3	DC	DC0021199	District of Columbia WWTP	60
3	DE	DE0020320	Wilmington	40
3	MD	MD0067547	LaVale CSOs	3
3	MD	MD0021571	Salisbury City	2
3	MD	MD0021598	Cumberland WWTP	18
3	MD	MD0021601	Patapsco WWTP	1
3	MD	MD0021636	Cambridge WWTP	14
3	MD	MD0067384	Westernport Town	2
3	MD	MD0067407	Allegany County CSOs	3
3	MD	MD0067423	Frostburg CSOs	15
3	PA	PA0036820	Galeton Borough Authority	4
3	PA	PA0036650	Titusville City	4
3	PA	PA0028673	Borough of Gallitzin WWTP	6
3	PA	PA0028631	Mid-Cameron Authority	1
3	PA	PA0028436	Elizabeth Borough STP	6
3	PA	PA0028223	Corry City Municipal Authority	3
3	PA	PA0039489	Garrett Boro SIP	2
3	PA	PA0028401	Dravosburg Borough STP	1
3	PA	PA0037044	Ford City WTP	3
3	PA	PA0037711	Everett Borough Municipal Authority	5
3	PA	PA0028207	Reynoldsville Sewer Authority	7
3	PA	PA0038920	Burnham Borough	4
3	PA	PA0027421	Norristown MWA	2
3	PA	PA0042234	Kittanning Borough STP	9
3	PA	PA0043273	Hollidaysburg Regional WWTP	4
3	PA	PA0043877	Greater Pottsville Area Sewer Authority (West End)	4
3	PA	PA0043885	Greater Pottsville Area Sewer Authority	56
3	PA	PA0070041	Mahanoy City (MCSA) STP	3

EPA Region	State	NPDES Permit Number	Facility Name	Number of Outfalls
3	PA	PA0037818	Saltsburg Borough STP	6
3	PA	PA0027227	Farrell City	4
3	PA	PA0027049	Williamsport Sanitary Authority West Plant	1
3	PA	PA0027057	Williamsport Sanitary Authority Central	3
3	PA	PA0027065	Lackawanna River Basin Sewer Authority-Archbald	6
3	PA	PA0027081	Lackawanna River Basin Sewer Authority-Clinton	9
3	PA	PA0027090	Lackawanna River Basin Sewer Authority-Throop	20
3	PA	PA0027103	DELCORA Chester STP	26
3	PA	PA0027111	New Kensington STP	5
3	PA	PA0027456	Greater Greensboro STP	39
3	PA	PA0027197	Harrisburg Authority	60
3	PA	PA0027693	Minersville Sewer Authority	7
3	PA	PA0027324	Shamokin-Coal Township Joint Sewer Authority	5
3	PA	PA0027391	Upper Allegheny Joint Sanitary Authority STP	19
3	PA	PAG064801	Shamokin City	33
3	PA	PA0027430	Jeannette WWTP	5
3	PA	PA0070386	Shenandoah STP	13
3	PA	PA0027570	Brush Creek STP	3
3	PA	PA0027626	Kiski Valley STP	32
3	PA	PA0027651	West Newton Borough STP	13
3	PA	PA0027120	Warren City	4
3	PA	PAG066127	Munhall Boro	4
3	PA	PAG066116	West View Borough	2
3	PA	PAG066117	City of Uniontown	28
3	PA	PAG066118	Borough of Turtle Creek	10
3	PA	PAG066119	Borough of Etna	8
3	PA	PAG066120	Borough of East Pittsburgh	3
3	PA	PAG066123	Borough of West Homestead	2
3	PA	PA0027014	Altoona City Authority-East	1
3	PA	PAG062201	Easton City	2
3	PA	PAG066126	Carnegie Borough	1
3	PA	PAG066113	Borough of Aspinwall	3
3	PA	PAG066128	Borough of Swissvale	1
3	PA	PAG066129	Mayview State Hospital	1
3	PA	PAG066130	Export Borough	5
3	PA	PAG066131	Freedom Borough	3
3	PA	PAG066132	East Rochester Borough	1
3	PA	PAG066134	Township of Lett	1
3	PA	PAG066122	East Conemaugh Borough	2
3	PA	PAG066121	City of Arnold	2
3	PA	PAG066125	Sharpsburg Borough	6
3	PA	PAG066105	Borough of Rankin	2
3	PA	PA0096229	Marianna-West Bethlehem STP	1
3	PA	PA0217611	City of Pittsburgh	217
3	PA	PA0027022	Altoona West STP	1
3	PA	PAG062202	Lackawanna River Basin Authority-Moosic	3
3	PA	PAG066124	Dale Borough	7
3	PA	PAG064802	Coal Township	33
3	PA	PAG066101	Pitcairn Borough	1
3	PA	PAG066102	Braddock Borough	8
3	PA	PAG066115	Ferndale Borough	5
3	PA	PAG066104	Bureau of Wilmerding	9

EPA Region	State	NPDES Permit Number	Facility Name	Number of Outfalls
3	PA	PAG066114	Borough of North Braddock	1
3	PA	PAG066106	Girty's Run JSA, Millvale	9
3	PA	PAG066107	Township of Stowe	7
3	PA	PAG066108	Township of Wilkins	2
3	PA	PAG066109	McDonald Sewage Authority	20
3	PA	PAG066110	Borough of Crafton	4
3	PA	PAG066111	Emsworth Borough	1
3	PA	PAG066112	Borough of McKee Rocks	3
3	PA	PA0092355	North Belle Vernon WPCP	16
3	PA	PAG066103	Borough of Homestead	1
3	PA	PA0023701	Midland Borough Municipal Authority STP	1
3	PA	PA0024490	Rockwood Boro STP	5
3	PA	PA0022306	Brownsville Municipal Authority-Shady Avenue STP	4
3	PA	PA0022331	West Elizabeth WWTP	1
3	PA	PA0023175	Kane Borough	2
3	PA	PA0023248	Berwick Area Joint Sewer Authority	4
3	PA	PA0022209	Bedford Borough Municipal Authority	2
3	PA	PA0023558	Ashland Borough	9
3	PA	PA0021814	Mansfield WWTP	4
3	PA	PA0023736	Tri-Borough Municipal Authority WWTP	2
3	PA	PA0024163	Cambria Township Sewer Authority (Revloc STP)	1
3	PA	PA0024341	Canton Borough Authority	1
3	PA	PA0024406	Mt. Carmel Municipal Authority	19
3	PA	PA0024449	Youngwood Borough STP	2
3	PA	PA0020125	Boro of Monaca STP	6
3	PA	PA0023469	Honesdale STP	9
3	PA	PA0021237	Newport Borough Municipal Authority	3
3	PA	PA0020397	Bridgeport Borough	6
3	PA	PA0020613	Waynesbug STP	2
3	PA	PA0020681	Sewickley WWTP	4
3	PA	PA0020702	Fayette City WWTP	2
3	PA	PA0020940	Tunkhannock Borough Municipal Authority	1
3	PA	PA0022292	Ebensburg WWTP	2
3	PA	PA0021148	Mt. Pleasant STP	6
3	PA	PA0024511	Redbank Valley Municipal Authority	1
3	PA	PA0021407	Point Marion WWTP	6
3	PA	PA0021521	Smethport Borough	1
3	PA	PA0021539	Williamsburg Borough	1
3	PA	PA0021571	Marysville Municipal Authority	3
3	PA	PA0021610	Blairsville Borough STP	16
3	PA	PA0021687	Wellsboro Municipal Authority	2
3	PA	PA0021113	Glassport STP	5
3	PA	PA0026492	Scranton WWTF	78
3	PA	PA0024481	Meyersdale STP	5
3	PA	PA0026204	Oil City STP	16
3	PA	PA0026301	Erie City STP	15
3	PA	PA0026310	Clearfield Municipal Authority	9
3	PA	PA0026352	Coraopolis WPCF	6
3	PA	PA0026182	Lansdale Borough	2
3	PA	PA0026476	Coaldale Landsford-Summitt Hill TP	6
3	PA	PA0026174	Franklin City General Authority	5
3	PA	PA0026557	Municipal Authority of the City of Sunbury	6

EPA Region	State	NPDES Permit Number	Facility Name	Number of Outfalls
3	PA	PA0026581	Scottsdale STP	8
3	PA	PA0026662	Philadelphia Water Department-Southeast	35
3	PA	PA0026671	Philadelphia Water Department-Southwest	83
3	PA	PA0026743	Lancaster City	5
3	PA	PA0026689	Philadelphia Water Department-Northeast	59
3	PA	PA0026361	Lower Lackawanna Valley Sanitary Authority	26
3	PA	PA0025950	City of Monongahela	1
3	PA	PA0024589	Leetsdale STP	6
3	PA	PA0024686	Mid Mon Valley WPCP	8
3	PA	PA0024716	Freeland WWTP	1
3	PA	PA0024864	Ligonier Boro STP	2
3	PA	PA0025224	St. Clair S.A. WWTP	7
3	PA	PA0026191	Huntington Borough	6
3	PA	PA0025810	Shade-Central City STP	3
3	PA	PAG066133	Rochester Borough	5
3	PA	PA0025984	Allegheny County Sanitary Authority	21
3	PA	PA0026042	Bethlehem WWTP	3
3	PA	PA0026069	Latrobe Borough	18
3	PA	PA0026107	Wyoming Valley Sewer Authority	54
3	PA	PA0026140	Rochester Area Joint Sewer Authority WTP	1
3	PA	PA0026158	Monongahela Valley WWTP	21
3	PA	PA0025755	Borough of Freeport STP	6
3	PA	PA0026832	Ellwood City Borough	1
3	PA	PA0027006	Tamaqua Borough Sewer Authority	13
3	PA	PA0026981	City of Duquesne STP	4
3	PA	PA0026921	Hazleton WTP	14
3	PA	PA0026913	McKeesport WPCP	28
3	PA	PA0026905	Connellsville STP	16
3	PA	PA0026891	Charleroi STP	12
3	PA	PA0020346	Punxsutawney Sewer Authority STP	4
3	PA	PA0026824	Clairton STP	5
3	VA	VA0024970	Lynchburg STP	36
3	VA	VA0063177	Richmond WWTW	29
3	VA	VA0087068	Alexandria CSOs	4
3	WV	WV0023167	Martinsburg	1
3	WV	WV0020648	City of Benwood	14
3	WV	WV0027324	Monongah	2
3	WV	WV0026832	Wellsburg	10
3	WV	WV0025461	City of Bridgeport	12
3	WV	WV0027472	New Martinsville	10
3	WV	WV0028088	Weston	5
3	WV	WV0020621	Montgomery	5
3	WV	WV0084042	Flatwoods-Canoe Run PSD	5
3	WV	WV0020109	Town of West Union	7
3	WV	WV0020028	City of Elkins	19
3	WV	WV0020150	Moorefield	2
3	WV	WV0024856	Thomas	1
3	WV	WV0020273	City of Follansbee	5
3	WV	WV0105279	City of Piedmont	7
3	WV	WV0029289	City of Belington	7
3	WV	WV0084310	Greater Paw Paw Sanitary District	7
3	WV	WV0024848	Town of Davis	3

EPA Region	State	NPDES Permit Number	Facility Name	Number of Outfalls
3	WV	WV0081434	Town of Barrackville	12
3	WV	WV0054500	City of Shinnston	10
3	WV	WV0035939	Boone County PSD	5
3	WV	WV0035912	City of Kenova	2
3	WV	WV0035637	Cedar Grove	1
3	WV	WV0028118	Dunbar	17
3	WV	WV0033821	City of Logan	10
3	WV	WV0100901	Nutter Fort	2
3	WV	WV0023175	St. Albans	3
3	WV	WV0021865	City of Farmington	1
3	WV	WV0021857	City of Philippi	13
3	WV	WV0021822	Grafton	39
3	WV	WV0023094	Princeton	1
3	WV	WV0022080	Town of Bethany	3
3	WV	WV0022063	City of Parsons	5
3	WV	WV0022039	Point Pleasant	2
3	WV	WV0024732	City of Hinton	6
3	WV	WV0022004	Richwood	2
3	WV	WV0032336	Buckhannon	5
3	WV	WV0021881	Kingwood	3
3	WV	WV0021750	Marmet	3
3	WV	WV0021741	Smithers	4
3	WV	WV0023124	City of Morgantown	40
3	WV	WV0023299	Nitro	6
3	WV	WV0024589	Welch	26
3	WV	WV0024562	City of Wayne	3
3	WV	WV0024473	Marlington	1
3	WV	WV0024449	City of Westover	5
3	WV	WV0024392	Keyser	1
3	WV	WV0020681	Mullens	3
3	WV	WV0023302	City of Clarksburg	55
3	WV	WV0023159	Huntington	25
3	WV	WV0023264	City of Moundsville	6
3	WV	WV0023230	Wheeling	137
3	WV	WV0023205	Charleston	55
3	WV	WV0023183	Beckley	1
3	WV	WV0020141	McMechen	3
3	WV	WV0023353	Fairmont	43
4	GA	GA0037109	Atlanta-Tanyard Creek	1
4	GA	GA0037168	Atlanta-Intrenchment and Custer Avenue	2
4	GA	GA0037133	Atlanta-McDaniel Street	1
4	GA	GA0037117	Atlanta-Proctor Creek/North	1
4	GA	GA0036871	Atlanta-Clear Creek	1
4	GA	GA0036854	City of Albany CSOs	8
4	GA	GA0036838	Columbus CSO	2
4	GA	GA0037125	Atlanta-Proctor Creek/Greenferry	1
4	KY	KY0020095	Owensboro-West	8
4	KY	KY0022373	Ashland WWTP	8
4	KY	KY0027413	Prestonsburg WWTP	1
4	KY	KY0020257	Maysville WWTP	11
4	KY	KY0020711	Henderson WWTP	15
4	KY	KY0021440	Morganfield WWTP	2

EPA Region	State	NPDES Permit Number	Facility Name	Number of Outfalls
4	KY	KY0021466	Northern Kentucky S.D. #1	71
4	KY	KY0021512	Vanceburg WWTP	5
4	KY	KY0026115	Loyall WWTP	6
4	KY	KY0026093	Harlan WWTP	1
4	KY	KY0022411	Morris Forman WWTF	115
4	KY	KY0035467	Catlettsburg WWTP	5
4	KY	KY0025291	Pikeville WWTP	3
4	KY	KY0024058	Pineville STP	3
4	KY	KY0022926	Worthington WWTP	3
4	KY	KY0022861	E.C. McManis WWTP	20
4	KY	KY0022799	Paducah WWTP	11
4	TN	TN0020575	Nashville	30
4	TN	TN0020656	Clarksville	2
4	TN	TN0024210	Chattanooga	9
5	IL	IL0029815	City of Mason City	1
5	IL	ILM580035	Village of Niles CSOs	8
5	IL	IL0022471	Glenbard WW Authority-Lombard	2
5	IL	IL0028070	MWRDGC-Lemont WRP	1
5	IL	ILM580031	City of Blue Island CSOs	5
5	IL	ILM580034	Lincolnwood CSOs	2
5	IL	ILM580003	Village of Melrose Park CSO	1
5	IL	ILM580030	Village of North Riverside CSOs	2
5	IL	IL0066818	Hinsdale CSOs	4
5	IL	IL0068365	Marshall STP	2
5	IL	ILM580012	Wilmette CSO	1
5	IL	IL0070505	City of Elgin CSOs	12
5	IL	IL0021253	Monmouth Main WWTP	6
5	IL	ILM580009	Village of LaGrange CSOs	3
5	IL	ILM580023	Village of Stickney CSOs	1
5	IL	IL0072001	Bloomington CSOs	6
5	IL	IL0030660	City of Peru STP	22
5	IL	IL0034495	Pekin STP 1	4
5	IL	IL0033618	Village of Villa Park CSOs	4
5	IL	ILM580008	LaGrange Park CSOs	3
5	IL	IL0033472	East St. Louis CSOs	2
5	IL	IL0031852	Wood River STP	1
5	IL	IL0031356	Taylorville S.D. STP	2
5	IL	IL0045039	Village of Western Springs CSOs	4
5	IL	IL0030783	Rock Island	6
5	IL	IL0037800	City of Peoria CSOs	16
5	IL	IL0030503	Quincy STP	6
5	IL	IL0030457	Pontiac STP	5
5	IL	IL0030384	Ottawa STP	14
5	IL	IL0030015	Morton STP 2	2
5	IL	IL0029874	City of Metropolis STP	1
5	IL	IL0029831	Mattoon WWTP	4
5	IL	IL0031216	Spring Valley WWTP	9
5	IL	ILM580011	Dixmoor CSO	1
5	IL	ILM580036	Skokie CSOs	3
5	IL	IL0045012	Chicago CSOs	231
5	IL	ILM580007	Village of Riverdale CSOs	4
5	IL	ILM580021	Village of River Grove CSO	6

EPA Region	State	NPDES Permit Number	Facility Name	Number of Outfalls
5	IL	ILM580013	Village of Schiller Park CSO	1
5	IL	ILM580032	Brookfield CSOs	6
5	IL	IL0035084	City of Casey STP	1
5	IL	ILM580014	Park Ridge CSOs	4
5	IL	ILM580002	City of Evanston CSOs	15
5	IL	ILM580026	Des Plaines CSO	2
5	IL	ILM580037	Posen CSO	1
5	IL	IL0043061	Prophetstown STP	2
5	IL	ILM580018	Village of Burnham CSOs	3
5	IL	IL0039551	Village of Lemont CSOs	2
5	IL	ILM580028	City of Markham CSO	1
5	IL	IL0029424	LaSalle WWTP	3
5	IL	ILM580025	City of Calumet City CSOs	7
5	IL	IL0022004	City of Streator STP	17
5	IL	IL0029564	Lincoln STP	2
5	IL	IL0023272	Milford STP	4
5	IL	IL0023141	Galesburg Sanitary District	40
5	IL	IL0022675	Carlinville STP	1
5	IL	IL0022519	City of Joliet-Eastside STP	9
5	IL	IL0022462	Farmer City STP	2
5	IL	IL0023388	Havana STP	2
5	IL	IL0022161	Watseka STP	6
5	IL	IL0023825	Cairo STP	3
5	IL	IL0021989	Spring Creek STP	6
5	IL	IL0021971	Sugar Creek STP	2
5	IL	IL0021873	City of Belleville STP #1	15
5	IL	IL0021792	Wenona WWTP	1
5	IL	IL0021661	Jacksonville STP	2
5	IL	IL0021601	Fairbury STP	11
5	IL	IL0021423	Village of Hartford CSO	1
5	IL	IL0022331	Granville STP	4
5	IL	IL0028053	MWRDGC Stickney, West-Southwest STP	15
5	IL	ILM580015	Riverside CSOs	5
5	IL	IL0028657	Fox River WRD-South STP	1
5	IL	IL0028622	Effingham STP	3
5	IL	IL0028592	Metro East S.D. CSOs	4
5	IL	IL0028321	S.D. of Decatur Main STP	4
5	IL	IL0028231	Cowden STP	1
5	IL	IL0023281	Gibson City STP	1
5	IL	IL0028061	MWRDGC Calumet Water Reclamation Plant	13
5	IL	IL0029467	Lawrenceville STP	4
5	IL	IL0027839	Canton-West STP	2
5	IL	IL0027731	Bloomington/Normal WRD/STP	9
5	IL	IL0027464	City of Alton STP	6
5	IL	IL0027367	Addison	1
5	IL	IL0026450	Dixon STP	4
5	IL	IL0025135	Beardstown S.D.	1
5	IL	IL0024996	City of Oglesby STP	7
5	IL	IL0028088	MWRDGC-Northside Water Reclamation Plant	9
5	IL	IL0047741	MWRDGC James C. Kire WRP	1
5	IL	ILM580020	City of Harvey CSOs	7
5	IL	ILM580006	Village of Arlington Heights CSO	1

EPA Region	State	NPDES Permit Number	Facility Name	Number of Outfalls
5	IL	ILM580016	Village of Calumet Park CSO	1
5	IL	ILM580004	Village of Lyons CSOs	3
5	IL	ILM580019	Village of Forest Park CSOs	2
5	IL	ILM580005	Village of Morton Grove CSOs	2
5	IL	ILM580029	Franklin Park CSOs	4
5	IL	ILM580022	Village of Maywood CSOs	8
5	IL	IL0048518	Aurora CSOs	16
5	IL	ILM580033	Summit CSOs	4
5	IL	IL0072389	Golf CSOs	1
5	IL	IL0021113	City of Morris STP	5
5	IL	IL0021059	Marseilles STP	1
5	IL	ILM580024	Village of River Forest CSOs	2
5	IL	IL0020621	Litchfield STP	1
5	IL	ILM580017	Village of Dolton CSOs	3
5	IL	IL0072834	Phoenix CSOs	1
5	IL	IL0072508	Town of Normal CSOs	0
5	IL	ILM580010	Village of South Holland CSOs	5
5	IL	IL0020818	Fox Metro Water Reclamation District	1
5	IN	IN0035696	Mt. Vernon WWTP	3
5	IN	IN0024520	City of South Bend WWTP	44
5	IN	IN0023183	Indianapolis-Belmont	131
5	IN	IN0024473	City of Seymour WWTP	1
5	IN	IN0024414	Rensselaer	17
5	IN	IN0020044	City of Alexandria WPCP	3
5	IN	IN0024406	Town of Redkey POTW	6
5	IN	IN0024023	Paoli Municipal STP	8
5	IN	IN0033073	Evansville East WWTP	8
5	IN	IN0023914	City of New Castle WWTP	8
5	IN	IN0023752	Michigan City	2
5	IN	IN0023736	Markle WWTP	2
5	IN	IN0023621	Lowell Municipal STP	1
5	IN	IN0023604	City of Logansport WWTP	16
5	IN	IN0023582	Ligonier WWTP	6
5	IN	IN0024554	City of Sullivan WWTP	5
5	IN	IN0050903	City of Aurora WW Collection System	5
5	IN	IN0024805	Warsaw WWTP	1
5	IN	IN0038318	Milford	1
5	IN	IN0039314	City of Decatur WWTP	4
5	IN	IN0023302	Jeffersonville	16
5	IN	IN0032719	Elwood	15
5	IN	IN0031950	Indianapolis-South Port	2
5	IN	IN0032191	City of Fort Wayne WWTP	42
5	IN	IN0032328	City of Peru WWTP	16
5	IN	IN0032336	Connersville	5
5	IN	IN0032468	Lafayette	15
5	IN	IN0024775	Wakarusa WWTP	7
5	IN	IN0032573	City of Columbus POTW	3
5	IN	IN0025674	City of Elkhart WWTP	39
5	IN	IN0032875	City of Kokomo Municipal Sanitation Utility	30
5	IN	IN0032956	Evansville Westside WWTP	15
5	IN	IN0032964	City of Crawfordsville WWTP	2
5	IN	IN0032972	Civil Town of Speedway WWTP	2

EPA Region	State	NPDES Permit Number	Facility Name	Number of Outfalls
5	IN	IN0023132	City of Huntington WWTP	15
5	IN	IN0023060	Hammond WWTP	20
5	IN	IN0032476	Anderson WWTP	17
5	IN	IN0025607	City of Terre Haute POTW	10
5	IN	IN0024660	Elden Kuehl Pollution Control Facility	2
5	IN	IN0024716	Veedersburg WWTP	1
5	IN	IN0024741	City of Wabash WWTP	8
5	IN	IN0024791	Warren	3
5	IN	IN0024821	West Lafayette WWTP	5
5	IN	IN0025232	Town of Akron WWTP	3
5	IN	IN0025763	City of Crownpoint WWTP	5
5	IN	IN0025585	City of Marion WWTP	9
5	IN	IN0025755	City of Goshen WWTP	6
5	IN	IN0025615	William Edwin Ross WWTP	4
5	IN	IN0025631	Muncie Sanitary District	25
5	IN	IN0025640	City of Mishawaka WWTP	19
5	IN	IN0025658	Washington Municipal STP	5
5	IN	IN0025666	City of Madison WWTP	7
5	IN	IN0024562	Summitville	2
5	IN	IN0025577	LaPorte Municipal STP	1
5	IN	IN0020427	Bremen WWTP	2
5	IN	IN0020109	Greenfield	0
5	IN	IN0020907	Rossville	2
5	IN	IN0020877	North Judson Municipal STP	2
5	IN	IN0020770	Middletown	3
5	IN	IN0020745	Ossian WWTP	6
5	IN	IN0020711	Waterloo Municipal STP	2
5	IN	IN0020672	Auburn WWTP	4
5	IN	IN0020664	Avilla WWTP	1
5	IN	IN0020656	City of Kendallville WWTP	1
5	IN	IN0020567	South Whitley Municipal STP	2
5	IN	IN0020991	Plymouth Municipal STP	10
5	IN	IN0020451	North Vernon WWTP	2
5	IN	IN0021016	Tell City WWTP	5
5	IN	IN0020362	North Manchester STP	8
5	IN	IN0020346	New Haven STP	4
5	IN	IN0020222	Attica	2
5	IN	IN0020176	Monticello Municipal STP	5
5	IN	IN0020168	City of Noblesville WWTP	7
5	IN	IN0020133	Greensburg WWTP	1
5	IN	IN0020125	Royal Center WWTP	1
5	IN	IN0020117	Montpelier WWTP	4
5	IN	IN0020095	Portland Municipal STP	16
5	IN	IN0020001	Ridgeville WWTP	3
5	IN	IN0022977	Gary WWTP	14
5	IN	IN0020516	Winamac Municipal STP	5
5	IN	IN0021628	Hartford City	17
5	IN	IN0022829	East Chicago S.D.	3
5	IN	IN0022683	Town of Crothersville WWTP	2
5	IN	IN0022535	Centerville Municipal STP	0
5	IN	IN0022624	Columbia City WWTP	12
5	IN	IN0022608	City of Clinton POTW	6

EPA Region	State	NPDES Permit Number	Facility Name	Number of Outfalls
5	IN	IN0022578	Chesterton Municipal STP	1
5	IN	IN0022560	Chesterfield WWTP	0
5	IN	IN0022462	Butler	1
5	IN	IN0022420	Boonville	2
5	IN	IN0022411	City of Bluffton WWTP	1
5	IN	IN0020958	Fortville WWTP	7
5	IN	IN0021652	Eaton	2
5	IN	IN0022934	Frankfort	1
5	IN	IN0021474	Tipton Municipal STP	7
5	IN	IN0021466	Nappanee	13
5	IN	IN0021385	City of Knox WWTP	1
5	IN	IN0021369	Berne	3
5	IN	IN0021342	Oxford WWTP	3
5	IN	IN0021296	City of Angola WWTP	3
5	IN	IN0021270	Rushville	2
5	IN	IN0021245	Town of Brownsburg WWTP	2
5	IN	IN0021211	Brazil Municipal STP	3
5	IN	IN0021202	Plainfield Municipal STP	5
5	IN	IN0021105	Fairmount	16
5	IN	IN0021067	Rockport WWTP	1
5	IN	IN0022144	Albion	2
5	MI	MI0048046	Bloomfield Village CSO	1
5	MI	MI0026735	St. Joseph CSO	5
5	MI	MI0025453	Martin RTB	2
5	MI	MI0025500	Milk River CSO	1
5	MI	MI0025534	Birmingham CSO	1
5	MI	MI0025542	Dearborn CSO	19
5	MI	MI0025577	Saginaw WWTP	7
5	MI	MI0025585	Chapaton RTB	1
5	MI	MI0025631	Menominee WWTP	1
5	MI	MI0026069	Grand Rapids WWTP	10
5	MI	MI0026077	Grosse Pointe Farms CSO	7
5	MI	MI0024058	Sault Ste Marie WWTP	6
5	MI	MI0026115	Oakland County SOCSDS 12 Towns RTF	1
5	MI	MI0028819	River Rouge CSO	1
5	MI	MI0036072	Southgate/Wyandotte CSO RTF	2
5	MI	MI0048879	Crystal Falls CSO	2
5	MI	MI0051462	Wayne County/ Inkster/Dearborn Heights CSO	2
5	MI	MI0051471	Wayne County/Inkster CSO	10
5	MI	MI0051489	Wayne County/Dearborn Heights CSO	7
5	MI	MI0051535	Wayne County/Redford/ Livonia CSO	8
5	MI	MI0051811	Dearborn Heights CSO	1
5	MI	MI0051829	Redford Township CSO	1
5	MI	MI0051837	Inkster/Dearborn Heights CSO	1
5	MI	MI0037427	Oakland County-Acacia Park CSO	1
5	MI	MI0026085	Grosse Pointe Shores CSO	0
5	MI	MI0022284	Bay City WWTP	5
5	MI	MI0023973	Saginaw Township WWTP	0
5	MI	MI0020214	Norway WWTP	1
5	MI	MI0020362	Manistee WWTP	4
5	MI	MI0020591	St. Clair WWTP	0
5	MI	MI0020656	Marysville WWTP	1

EPA Region	State	NPDES Permit Number	Facility Name	Number of Outfalls
5	MI	MI0021083	Croswell WWTP	1
5	MI	MI0021440	Wakefield WWSL	1
5	MI	MI0021695	Blissfield WWTP	2
5	MI	MI0022152	Adrian WWTP	2
5	MI	MI0022802	Detroit WWTP	86
5	MI	MI0022853	East Lansing WWTP	2
5	MI	MI0022918	Essexville WWTP	1
5	MI	MI0023001	Gladwin WWTP	1
5	MI	MI0023205	Iron Mountain-Kingsford WWTP	1
5	MI	MI0023400	Lansing WWTP	30
5	MI	MI0023515	Manistique WWTP	1
5	MI	MI0023647	Mt. Clemens WWTP	1
5	MI	MI0023701	Niles WWTP	8
5	MI	MI0023833	Port Huron WWTP	14
5	MI	MI0043982	North Houghton County W&SA CSO	2
5	MN	MN0025470	MCWS-St. Paul	2
5	MN	MN0024571	Red Wing	1
5	MN	MN0046744	MCWS-Minneapolis	8
5	OH	OH0023981	City of Avon Lake	14
5	OH	OH0026671	Newark WWTP	25
5	OH	OH0026565	Village of Mingo Junction	6
5	OH	OH0026522	Middletown WWTP	8
5	OH	OH0026514	Middleport WWTP	13
5	OH	OH0026352	Marion Water Pollution Control	3
5	OH	OH0026263	City of McComb WWTP	2
5	OH	OH0026069	City of Lima WWTP	19
5	OH	OH0026026	Lancaster WWTP	31
5	OH	OH0026018	Lakewood WWTP	9
5	OH	OH0025852	Ironton WWTP	9
5	OH	OH0025771	Hicksville	5
5	OH	OH0024732	Columbus-Jackson Pike	31
5	OH	OH0025291	Fremont WWTP	13
5	OH	OH0024139	City of Bowling Green	1
5	OH	OH0025160	Fort Recovery WWTP	4
5	OH	OH0025151	Forest WWTP	3
5	OH	OH0025135	Findlay Water Pollution Control Center	18
5	OH	OH0025127	Fayette WWTP	15
5	OH	OH0025003	City of Elyria WWTP	27
5	OH	OH0024929	Delphos WWTP	6
5	OH	OH0024899	Defiance	44
5	OH	OH0024759	Columbus Grove	4
5	OH	OH0024741	Columbus-Southerly	1
5	OH	OH0058971	Luckey STP	4
5	OH	OH0026841	Oak Harbor	9
5	OH	OH0024686	City of Clyde WWTP	3
5	OH	OH0025364	City of Girard WWTP	4
5	OH	OH0031062	Euclid	18
5	OH	OH0020826	Village of Leipsic	1
5	OH	OH0126268	Lisbon WWTP	9
5	OH	OH0105457	Hamilton County Commissioners	213
5	OH	OH0094528	Village of Malta	9
5	OH	OH0020893	Napoleon WWTP	3

EPA Region	State	NPDES Permit Number	Facility Name	Number of Outfalls
5	OH	OH0058408	Metamora	4
5	OH	OH0023884	Village of Ansonia WWTP	2
5	OH	OH0052922	City of Bucyrus	22
5	OH	OH0052876	Port Clinton	2
5	OH	OH0052744	City of Fostoria	5
5	OH	OH0052604	City of Norwalk	3
5	OH	OH0049999	Eastern Ohio Regional Wastewater Authority	47
5	OH	OH0052949	Tiffin	30
5	OH	OH0043991	Northeast Ohio Regional Sewer District	126
5	OH	OH0027197	Portsmouth	10
5	OH	OH0029122	Village of Gibsonburg	3
5	OH	OH0028240	Zanesville WWTP	21
5	OH	OH0028223	City of Youngstown WTP	101
5	OH	OH0028185	Wooster	3
5	OH	OH0028177	Woodsfield WWTP	5
5	OH	OH0028118	City of Willard	3
5	OH	OH0027987	Warren	4
5	OH	OH0027952	Wapakoneta WWTP	4
5	OH	OH0027910	Van Wert	6
5	OH	OH0027740	Toledo	37
5	OH	OH0027511	Steubenville	16
5	OH	OH0027481	Springfield STP	58
5	OH	OH0027332	City of Sandusky	15
5	OH	OH0048321	Dunkirk	6
5	OH	OH0020192	Village of Bradford	9
5	OH	OH0020974	Delta WWTP	9
5	OH	OH0023833	City of Akron	38
5	OH	OH0020117	North Baltimore	2
5	OH	OH0020214	Toronto WWTP	7
5	OH	OH0020338	Village of Paulding	2
5	OH	OH0020451	City of Milford WWTP	2
5	OH	OH0020486	Village of Greenwich WWTP	10
5	OH	OH0020524	Village of Swanton	13
5	OH	OH0020559	Village of Caldwell WWTP	22
5	OH	OH0020591	Woodville	17
5	OH	OH0020613	Village of New Boston	2
5	OH	OH0020664	Crestline WWTP	1
5	OH	OH0020851	Bluffton WWTP	20
5	OH	OH0020940	Arcanum WWTP	14
5	OH	OH0021831	Montpelier WWTP	3
5	OH	OH0020001	Upper Sandusky	1
5	OH	OH0023400	City of Wauseon	4
5	OH	OH0023396	Ohio City	2
5	OH	OH0022471	Deshler WWTP	7
5	OH	OH0021008	Perrysburg Water Pollution Control	4
5	OH	OH0022110	Newton Falls WWTP	28
5	OH	OH0022578	Green Springs WWTP	1
5	OH	OH0021725	Pomeroy	13
5	OH	OH0021491	Bremen	1
5	OH	OH0021466	McConnelsville	11
5	OH	OH0021326	Village of Payne WWTP	2
5	OH	OH0021148	Village of Pandora WWTP	7

EPA Region	State	NPDES Permit Number	Facility Name	Number of Outfalls
5	OH	OH0021105	Hamler WWTP	6
5	OH	OH0022322	Put-In-Bay WWTP	3
5	WI	WI0025593	Superior Sewage Disposal System	3
5	WI	WI0024767	Milwaukee MSD-Jones Island	120
7	IA	IA0076601	Des Moines CSOs	18
7	IA	IA0058611	Ottumwa STP	10
7	IA	IA0047961	City of Wapello STP	2
7	IA	IA0043079	City of Burlington STP	12
7	IA	IA0042609	City of Keokuk STP	9
7	IA	IA0035947	City of Clinton STP	10
7	IA	IA0027219	City of Ft. Madison STP	9
7	IA	IA0021059	City of Spencer STP	4
7	IA	IA0020842	City of Lake City STP	1
7	IA	IA0023434	City of Muscatine STP	5
7	KS	KS0042722	Topeka City of Oakland STP	6
7	KS	KS0039128	Atchison City WWTP	9
7	KS	KS0038563	Kansas City WWTP (and Wyandotte County)	66
7	MO	MO0050580	Cape Girardeau WWTP	0
7	MO	MO0025178	MSD, Bissell Point WWTP	56
7	MO	MO0024929	Kansas City, Westside STP	6
7	MO	MO0023027	Sedalia North WWTP	1
7	MO	MO0024911	Kansas City, Blue River STP	218
7	MO	MO0023221	Macon WWTF	2
7	MO	MO0023043	St. Joseph WWTP	15
7	MO	MO0117960	Moberly East WWTP	4
7	MO	MO0025151	MSD, Lemay WWTP	149
7	NE	NE0133680	City of Omaha CSS	31
7	NE	NE0021121	Plattsmouth WWTF	0
8	SD	SD0027481	City of Lead	1
9	CA	CA0079111	Sacramento Regional County S.D.	6
9	CA	CA0037681	Oceanside WPCP and Westside Wet Weather CSO System	7
9	CA	CA0037664	Bayside WW Facilities WPCP & SF Southeast	29
10	AK	AK0023213	Juneau-Douglas WWTP	3
10	OR	OR0026361	City of Corvallis WWRP	4
10	OR	OR0026905	City of Portland Columbia Blvd WWTP	44
10	OR	OR0027561	City of Astoria WWTP	38
10	WA	WA0024473	City of Spokane	24
10	WA	WA0037061	City of Olympia	3
10	WA	WA0031682	City of Seattle	113
10	WA	WA0029548	Snohomish WWTP	2
10	WA	WA0029289	Bremerton WWTP	16
10	WA	WA0024490	City of Everett	14
10	WA	WA0024074	City of Mt. Vernon WWTP	2
10	WA	WA0023973	City of Port Angeles WWTP	5
10	WA	WA0023744	City of Bellingham WWTP	2
10	WA	WA0020257	City of Anacortes WWTP	3
10	WA	WA0029181	Metropolitan King County - West Point	40

Appendix E

GPRACSO Model Documentation

E.1 GPRACSO Database and GPRACSO Model

EPA developed the GPRACSO Database and GPRACSO Model to estimate CSO volume and the attendant pollutant loads on a national level. The GPRACSO Database contains information for all CSO communities in the United States. The GPRACSO Model estimates CSO volume and the BOD₅ load in CSOs for communities with combined sewer systems (CSSs). This documentation presents background on the sources of information and the methodology used to develop the GPRACSO Database and Model.

The GPRACSO Database includes information on all of the CSO communities across the United States. The primary sources of community-specific information include:

- EPA's CWNS (1992, 1996, and 2000)
- EPA's PCS database
- EPA's 2001 *Report to Congress- Implementation and Enforcement of the CSO Control Policy*
- EPA-sponsored municipal interviews with select CSO communities during 2002 and 2003
- Individual CSO community long-term control plan documentations
- Internet searches

The GPRACSO database contains information on how the CWNS Facility identifying numbers relate to CSO community names and NPDES numbers, and how complex CSO community systems connect to discharge into single regional POTWs. For highly detailed assessments of a single CSO community, the GPRACSO database may not have sufficiently accurate information. However, for EPA's efforts to summarize national conditions, the combination of the GPRACSO Database and the GPRACSO Model is sufficient for policy, cost, and technology assessments.

Each CSO community is represented as a specified land area within the GPRACSO Model, and each is associated with a known quantity of dry weather flow, and a known quantity of wet and dry weather treatment and wet weather storage. The GPRACSO Model is applied to represent annual average conditions. Typical rainfall years were developed from long-term meteorologic records for each CSO community. The key inputs to the GPRACSO model include: service area, population served, impervious cover, rainfall, temperature, treatment plant capacity, and wet weather storage. A detailed description of each of these parameters, including database sources, is provided in Table E.1

A "CSO community" is used herein to generically refer to the entity that terminates at a single POTW. Each POTW is evaluated as a single entity whether it is an individual sewer system or a totaled regional system. Wherever multiple CSO communities comprise a single regional system, a single data record, representing the total treatment capacity, wet-weather storage, and combined sewer service area of all the combined sewer communities in the regional system, is included in the GPRACSO Database.

The GPRACSO Model was used to estimate CSO volumes and BOD₅ concentrations for three national planning-level scenarios: baseline (1992) prior to CSO Control Policy, current level of control, and (future) full CSO Control Policy implementation. To accomplish this, the GPRACSO Model generates rainfall-derived runoff from each combined sewer area on an hourly basis, adds the runoff to dry weather flow, calculates the volume of combined sewage delivered to the POTW, and estimates CSO volume based on storage and treatment capacities. Hourly estimates of BOD₅ concentrations within CSSs are used to calculate the pollutant loads in CSOs and treated effluent from POTWs. The following sections provide more detail on the GPRACSO model algorithms and key assumptions.

Table E.1 Summary of Key Inputs to the GPRACSO Model

Combined Sewer System Description Parameters	
Service area acreage and population information	Estimated CSO service area data for 1992, 1996, and 2000 were obtained from a myriad of sources including CWNS. Where necessary, either population served or miles of sewer pipe were used to estimate source area. For a small fraction of the communities, other sources of service area included direct responses in EPA-sponsored interviews, published reports, and LTCPs.
Runoff coefficient	This coefficient was set to the impervious fraction of each community. Land use/land cover GIS layers from the USGS (EPA 2001) were used to aerial weight imperviousness based on five urban land use types. The boundary of each community was identified and was graphically superimposed on the USGS data.
Meteorologic data	
Rainfall	The United States was divided into 84 common hydrologic zones based on average annual precipitation, mean January air temperature, geography, and peak 2-year, 6-hour rainfall. For modeling purposes, rainfall is represented in terms of hourly rainfall amounts. It is presumed that all communities located in common zone would experience the same hydrologic conditions, including snow generation and melt. (EPA 2001)
Temperature	Once a “typical” rainfall year was identified for each of the 84 hydrologic zones, the associated hourly temperature record was taken from National Weather Service records such that snow generation and melting could be assessed. Estimated (modeled) snow accumulation and snow melt was based on hourly air temperatures using degree-day methodology (McCuen 1998).
Treatment System/Management System Parameters	
Dry weather and maximum wet weather POTW flow rates	Multiple sources have been reviewed to establish current and historic POTW treatment levels. The bulk of the information on POTWs originated from EPA’s PCS database. For use in the GPRACSO model, the median value was calculated for both average and maximum design POTW flow based on up to two years of reported daily average and daily peak discharge rates.
End-of-pipe wet-weather treatment capacity	Data was obtained from the internet, published literature, responses in EPA-sponsored interviews, and LTCPs.
Secondary bypass with flow recombination	Data was obtained from the internet, published literature, responses in EPA-sponsored interviews, and LTCPs.
Wet weather storage capacity	Data was obtained from the internet, published literature, responses in EPA-sponsored interviews, and LTCPs.

E.2 Simulation of Dry Weather Sanitary Flows

Average daily dry weather sanitary flows for CSO communities are based on discharge monitoring reports available in PCS. Typical flow peaking factors based on literature values are used to represent the hourly variation of sanitary flows relative to the average daily flow rate within the CSS and entering the POTW (Metcalf & Eddy 1991). For example, the GPRACSO model sets the minimum and maximum hourly sanitary inflows to 32 percent and 141 percent of the average daily reported POTW inflow. Wherever PCS or other data on both average and maximum POTW capacity are available for a CSO community, GPRACSO peaking factors are modified accordingly. Regardless of the conditions encountered, simulated average dry weather sanitary inflow into a POTW always matches the average inflow obtained from the best available source for each CSO community. The maximum daily dry weather inflow never exceeds the reported maximum daily POTW treatment capacity.

E.3 Dry Weather Sanitary Pollutant Concentration Estimation

For the purposes of this report, the GPRACSO Model was used to estimate the BOD₅ load associated with CSO discharges. The GPRACSO Model assumes that the average dry weather BOD₅ concentration entering the POTW is 158 mg/L, with minimum and maximum hourly values of 40 and 290 (mg/L), respectively. The average dry weather concentration and the diurnal (i.e., hourly) variations in pollutant concentration are based on the trend

reported by Metcalf & Eddy (1991) for the City of Chicago. There were no other influences on hourly dry weather concentrations unless there were additional inflow from snowmelt or from stored combined sewage returned from wet weather storage facilities. Algorithms associated with these two inputs are:

Flow source #1: The GPRACSO Model identifies that there is a snow pack present in the CSO community and that hourly air temperature is above 32 degrees.

Model Response	Assumptions
From the calculated melt rate, an estimate of the snowmelt is made, all of which is assumed to flow into the CSS. The relative volumes of dry weather sewage and snowmelt are used to calculate a reduction in the BOD ₅ concentration entering the POTW.	It is assumed that snowmelt contains zero pollutant and as a result dilutes the inflow entering the POTW.

Flow source #2: A CSO community has dedicated wet weather storage available to capture any wet weather flows in excess of the POTW maximum treatment capacity.

Model Response	Assumptions
The GPRACSO model tracks all of the storage volume along with the amount of pollutant (BOD ₅) it contains on an hourly basis.	GPRACSO assumes that the stored flow is discharged to the POTW as soon as there is available treatment capacity (i.e., the hourly POTW inflow is less than the reported maximum POTW treatment capacity).

E.4 Estimation of CSO Volume

The GPRACSO Model performs many hydrologic computations as it evaluates the potential and actual wet-weather inflow into the CSS. The data sources used and the computations performed are as follows.

Typical meteorological conditions were estimated for each CSO community based on a review of long-term data from the National Weather Service. CSO communities were geographically grouped based on hydrology into 84 common zones, and a typical rainfall year was identified for each zone. As a rule, the typical year contained within +/-10 percent of the annual average precipitation for that zone or location, and had no single rainfall event larger than the two-year return period rainfall. Depending on the zone evaluated, the typical rainfall year presents between 30 and 80 potential overflow-producing events for each CSO community within the zone. Hourly temperature records was associated with rainfall records for each zone so that snow accumulation and melting could be included in the GPRACSO Model simulation.

Runoff calculations were performed using the rational method, which multiplies hourly rainfall by a single coefficient to calculate the runoff. The coefficient was set to equal the overall impervious cover of each CSO community. As described in Table E.1 under runoff coefficient, land use/land cover GIS layers from the USGS were used to help estimate the geographically weighted imperviousness for the land area found within the political boundaries of the CSO communities.

Snow accumulation and melting were calculated using a degree-day approach applied on an hourly basis (McCuen 1989). The GPRACSO Model monitors the conditions in each CSO community to determine if snow pack is present and if it is aggregating or shrinking in any simulated hour. Each hour's temperature was evaluated to establish the potential snowmelt, and snowmelt was simulated if a snow pack existed.

POTW wet weather treatment capacity is an important management feature. The GPRACSO model assumes the average event-period wet weather POTW treatment capacity is 130 percent of the reported maximum daily treatment rate. Rainfall and CSO events often occur over a period between two and eight hours, a period short enough for POTWs to “max-out” their systems at a greater rate than possible for a full 24-hour period. For example, if DMR data for a single POTW indicates 100 MGD is the maximum daily discharge rate (the median of maximum monthly values reported in PCS), then GPRACSO assumes that the POTW can actually treat 130 MGD over the short-term (i.e., during wet weather conditions). This 130 percent rule was developed from in-depth comparison between GPRACSO simulations and the results of local models/studies for four CSO communities.

The GPRACSO simulation assumes the POTW secondary treatment capacity above the simulated hourly dry weather inflow (the annual average daily POTW inflow multiplied by the appropriate hourly peaking factor) is available for treating potential CSO. So a POTW with a daily 100 MGD maximum secondary treatment capacity and an estimated *hourly* dry weather flow rate of 76 MGD (at 2 pm) would have 54 MGD capacity available between 2 and 3 pm to manage any wet weather flows (resulting from 100 MGD *1.3 - 76 MGD). At 3 pm, the estimated dry weather flow would be about 71 MGD, so any wet weather flows entering the system between 3 and 4 pm would be treated up to 59 MGD (resulting from 100 MGD *1.3 - 71 MGD).

Wet weather end-of-pipe (EOP) treatment was assumed to occur only after both the maximum wet weather treatment capacity of the POTW and any wet weather storage is fully utilized during a CSO event. The GPRACSO Model uses EOP as a last resort treatment, and it cannot be used to drain stored wet weather flows. EOP treatment technologies considered by the GPRACSO Model include things like vortex treatment facilities.

Wet weather storage was simulated using a built-in algorithm within the GPRACSO Model. The algorithm assesses the operation of wet weather storage facilities designed to capture and hold wet weather flows until treatment capacity is available. The operation of wet weather storage is simulated such that any hourly flows in excess of POTW treatment would go directly to wet weather storage. Only after all available wet weather storage is filled and EOP treatment capacity is exceeded will GPRACSO simulate a CSO discharge. Available POTW capacity for draining storage is defined as the difference between the maximum POTW treatment rate and the flow entering the simulated POTW for any given hour.

Conveyance limits for combined sewer interceptor systems are not considered by the GPRACSO Model. The GPRACSO Model assumes that the total interceptor system discharging into a POTW has a capacity greater than the maximum treatment rate of the POTW. As a result, the limiting factor within the GPRACSO Model is the POTW wet weather treatment capacity. While it is acknowledged that this assumption is not appropriate for some CSO communities, maximization of flows to the POTW is a required minimum control measure under EPA’s CSO Control Policy.

E.5 Estimation of CSO Pollutant Loads

The GPRACSO Model attempts to recognize the major influences on CSS pollutant concentration on an hour-to-hour basis. The influences accounted for include:

- Flushing of accumulated materials from the CSS
- Dilution of sanitary flows by storm water inflow late in the overflow periods
- Variation in sanitary flow rate and concentration through the day

The first two influences are lumped into a single load or calculation referred to as “storm water pollutant load”. This load represents the combination of *pollutants flushed from pipes* and *pollutants washed from the urban surface*,

independent of any sanitary inflow rates. In order to estimate the BOD₅ loadings attributable to storm water (including the flushing of settled pollutant in pipes), the following exponential relationship between time and BOD₅ concentration was applied:

$$\text{Equation 1. } C = (200 * 10^{-1.5*(t)}) + 15$$

Where:

C = the BOD₅ concentration in mg/L used to calculate the storm water load

t = time in hours since the overflow started

15 = the BOD₅ concentration in mg/L assumed to be in urban storm water

Information from two data sources was used to develop the above relationship. The first data source is multi-event CSO monitoring results of first-flush concentrations in combined sewers for a medium-sized east coast CSO community. The second data source was from 90th percentile event mean concentration BOD₅ concentrations reported in EPA's Nationwide Urban Runoff Program (EPA 1985). The first data source suggests that BOD₅ concentrations (grab samples in sewers) at the very start of runoff events range between 200 and 400 mg/L, but that concentrations decrease rapidly within the first hour of runoff. As a result, the average first hour BOD₅ concentration is set to be 215 mg/L, using the equation above. The second data source suggests a high-end long-term urban runoff BOD₅ concentration in the absence of CSOs is approximately 15mg/L, a feature also provided by the equation above.

Calculation of hourly overflow concentration in storm water/sanitary mix. While the first flush effect results in a high concentration of BOD₅, later in the CSO event storm water dilutes the more concentrated sanitary flows. As a result, the GPRACSO Model continuously mixes the sanitary flow/pollutant load with the storm water runoff/pollutant load each hour to calculate the average hourly concentration. It is assumed that the mixing of sanitary and storm water is 100 percent complete for each hour simulated and that any CSOs that occur will contain the same pollutant concentration as what enters the simulated POTW. The logic used to select the uniform BOD₅ concentration for any particular hour is:

If EventTime = 0 (the runoff has just started entering the CSS), then

$$\text{CSCConc}(\text{ttt},0) = (200 * 10^{-1.5*(\text{event time})}) + 15$$

If EventTime > 0 (the overflow event is progressing), then

$$\text{CSCConc}(\text{ttt},0) = (200 * 10^{-1.5*(\text{event time})}) + 15$$

If CSCConc(ttt,0) < DWBODconc * hours, then

$$\text{CSCConc}(\text{ttt},0) = (\text{HRDischarge}(\text{ttt},0) - \text{HRDWF}(\text{ttt},0)) * (\text{CSCConc}(\text{ttt},0) + \text{HRDWF}(\text{ttt},0) * \text{DWBODconc} * \text{hours}) / \text{HRDischarge}(\text{ttt},0)$$

EventTime = time since the start of the overflow event (hours)

CSCConc = uniform concentration of the storm water/sanitary mixture (mg/L) from the combined sewer community

DWBODconc * hours = the sanitary flow concentration in the absence of overflow (mg/L) for the "hour" under simulation

HRDischarge(ttt,0) = the simulated total hourly flow in the combined sewer (MGD)

HRDWF(ttt,0) = the hour's sanitary flow rate in the absence of overflow (MGD)

The CSCConc(ttt,0) value is used to compute the CSO BOD₅ load, the inflow load entering the POTW, and the pollutant load stored in any wet weather storage that may be present in the system. For BOD₅, the assumed storm water concentration for the first hour when overflow occurs is 215 mg/L regardless of when it occurs in the day. For any subsequent hour in which overflow can occur, the BOD₅ concentration is the greater of (1) the

value taken from Equation 1 based on the time elapsed since the start of the overflow, or (2) the flow weighted combination of Equation 1 and the dry weather sanitary flow concentration based on hourly variation. The first flush is recognized as the strongest influence on concentration at the beginning of the event, the dominant role of storm water dilution is recognized later in the event, and the daily variation in sanitary flow concentration is accounted for throughout the event.

E.6 Comparison with Other Estimates

EPA compared GPRACSO results against those of “local CSO models” of varying complexity and sophistication in five CSO communities. While there is no guarantee that they are correct, the local CSO models were developed to support LTCPs, and were assumed to be reasonably accurate. EPA used the departure from local CSO model estimates to gage the relative accuracy of the GPRACSO Model. Based on the local CSO model results, EPA established the following error brackets for GPRACSO estimates:

- CSO volumes are within +/- 50 percent of local CSO model estimates
- CSO community-wide average annual pollutant EMCs are at +/- 80 percent of local CSO model estimates
- CSO pollutant loads are within +/- 80 percent of local model estimates

Overall, errors originate from two principal sources: inaccuracies in data describing CSO communities, and errors resulting from the GPRACSO Model algorithms. EPA believes that the larger error is associated with the first source; that the bulk of the model error originates from errors in the basic system data (e.g., the combined sewer service area in each CSS). For several years, EPA has collected data to improve its understanding of historic, current, and future conditions in communities with combined sewers, obtaining better data each year. Additional investigation of CSO communities is anticipated to improve the assessment with the GPRACSO Model and its associated database.

To date, an in-depth comparison of local models and GPRACSO algorithms has not been performed. For the GPRACSO Model, extensive efforts were made to account for the majority of physical and hydrologic factors encountered in the generation of sanitary and storm water flows. Reasonable data sources are used to estimate the performance of POTWs and the operation of wet weather treatment and storage. However, the GPRACSO Model greatly simplifies the influence of geographic dissimilarities to each city, e.g., network of sewer pipes and pump stations are not explicitly modeled.

E.7 Summary

The GPRACSO Database and application of the GPRACSO Model have been applied to estimate the CSO volume and annual BOD₅ load for all combined sewer communities nationwide. The GPRACSO Model has been applied to estimate the current annual performance expected under rainfall that are both local to each community and typical on an annual basis. In addition, GPRACSO model results are conditions based on historic POTW performance data. Recent POTW upgrades and/or new wet weather management facilities may not be incorporated within the current version of the GPRACSO database. (Note: EPA is continuously collecting data on CSS facilities that can be used to update the GPRACSO database). For this reason, the estimates produced by the GPRACSO simulation may not fully recognize current management.

For its analysis of CSO regulations, EPA has used the typical or average meteorologic conditions faced by each community to analyze annual CSO management performance, and then summed all communities to obtain a national total performance. The GPRACSO Model estimates of the typical performance will vary from the *actual* performance measured at a specific place and time, in a single community. This is because the actual

meteorologic conditions (e.g., the weather at 12 PM on May 1, 2002) will vary from that found in the matching hours meteorologic record for the selected typical year.

References

EPA. 1983. *Results of the Nationwide Runoff Program*, Vol 1, Final Report. NTIS PB84-185552.

EPA. Office of Science and Technology. 2001. *Better Assessment Science Integrating Point and Nonpoint Sources: BASINS Version 3.0, User's Manual*. EPA 823-B-01-001.

McCuen, R.H. 1989. *Hydrologic Analysis and Design*, 2nd edition. Prentice-Hall. Upper Saddle River, NJ.

Metcalf & Eddy. 1991. *Wastewater Engineering Treatment, Disposal, Reuse*, 3rd edition. McGraw Hill International.

Water Environment Federation (WEF) and American Society of Civil Engineers (ASCE). 1998. *Urban Runoff Quality Management. WEF Manual of Practice No. 23. ASCE Manual and Report on Engineering Practice No. 87*. Reston, VA: ASCE.

Appendix F

Analysis of CSO Receiving Waters
Using the National Hydrography
Dataset (NHD)

F.1 Background

EPA compiled a national inventory of NPDES permits for CSO facilities during the development of the *Report to Congress—Implementation and Enforcement of the Combined Sewer Overflow Control Policy* (EPA 2001). Data collection, management, and analysis are documented in Appendix F of the 2001 report. The national CSO inventory was developed from a review of permit files and information provided by NPDES authorities. The resulting inventory included a summary of total CSO outfalls per permit and, where available, a narrative descriptions of CSO outfall location (e.g., “near intersection of Water and Main Streets”) and/or by spatial coordinates (i.e., latitude and longitude). This inventory was reviewed by states and EPA regions to determine if the total number CSO outfalls was correct, but the information on outfall location was not verified as part of the 2001 report effort.

F.2 Objectives

As specified in the Consolidated Appropriations Act for Fiscal Year 2001 (P.L. 106-554):

*..the Environmental Protection Agency shall transmit to Congress a report summarizing—
(1) the extent of the human health and environmental impacts caused by municipal combined sewer overflows and sanitary sewer overflows, including the location of discharges causing such impacts, the volume of pollutants discharged, and the constituents discharged; ...*

Given this requirement, and with the CSO permit inventory in-place from the 2001 report, EPA established a goal of updating the CSO data to include geographical locations for CSO outfalls included in CSO permits. EPA’s overriding objective for this effort was to provide a framework for identifying areas at and downstream of CSO outfalls to examine potential environmental and human health impacts.

F.3 Development of a National CSO Outfalls GIS Database

EPA began the process of geographically locating CSO outfalls by building on data originally collected for the 2001 report. The CSO permit inventory was updated through a review by states and EPA regions. Based on the latest data updates, EPA obtained latitude and longitude for outfalls included in more than two-thirds of active CSO permits. Most of the other permits had narrative descriptions locating CSO outfalls. These narrative descriptions varied, but generally mentioned the nearest cross-street or public landmark and often included the name or description of the receiving waterbody.

EPA extracted CSO outfalls with narrative location descriptions. EPA utilized ESRI ArcGIS for the geo-spatial processing and analysis of these outfalls. EPA developed a GIS base map of land areas, transportation networks, and local waterbodies for each CSO permit to help locate outfalls based on narrative data. The analysis utilized the Census 2000 Topologically Integrated Geographic Encoding and Referencing (TIGER®) database of the U.S. Census Bureau for reference mapping. The geographic data for the TIGER® database is freely available from ESRI in ArcGIS format. The TIGER® database includes geographic data for roads, railroads, hydrography, utility lines, and government entities (e.g., places and counties).

EPA extracted TIGER® base map data for over 200 areas to match the more than 2,000 narrative outfall locations to a spatial location. A combination of ArcGIS address mapping (where street data were available) and visual identification were employed to match the narrative location to a geographic point. Once located, additional descriptive information was used to verify the position. This included comparing the ArcGIS mapped position relative to receiving waters or distance from landmarks recorded in the CSO inventory. Narrative locations

not identifiable within the ArcGIS analysis were excluded, and points that could not be confirmed with other narrative descriptive locators were flagged for follow-up with the NPDES authority and were updated as necessary. Upon completion of identification and updates, the spatially-referenced CSO outfall latitude and longitude coordinates were computed and exported.

With this procedure, over 90 percent of CSO outfalls were geographically mapped. These outfalls were then tested for data quality and consistency. The CSO outfalls were intersected with available GIS data (states, watersheds, and waterbodies). CSO permits were linked to PCS to supplement data for descriptive outfall locations within the CSO inventory. Spatially-referenced CSO outfalls with state, watershed 8-digit HUC, or waterbody information from PCS inconsistent with that obtained from the ArcGIS base data were flagged for review by the NPDES authority. Upon completion of review and incorporation of available updates, the CSO outfalls associated with nearly 95 percent of active CSO permits were geographically referenced, as shown in Figure F.1. The spatially-referenced CSO outfalls served as a data source for evaluating and assessing potential environmental and human health impacts from CSO discharges.

F.4 Available EPA Data Sources

EPA conducted literature reviews and developed an inventory of possible data sources at the federal, state, and local levels that could be used to assess potential impacts from CSOs. The listing below reflects national scale data sources used to assess potential impacts from CSOs. These descriptions include website citations where the data source is described in more detail, including references to data dictionaries and/or other metadata, analyses conducted, and findings. The application of these data sources for this Report to Congress is presented in the next section.

Figure F.1 Location of CSO Outfalls



Permit Compliance System (PCS) - <http://www.epa.gov/enviro/html/pcs/>

Discharge of pollutants into waters of the United States is regulated under the NPDES program, a mandated provision of the Clean Water Act. To assist with the regulation process, state and federal regulators use an information management system known as PCS. PCS stores data about NPDES facilities, permits, compliance status, and enforcement activities for up to six years. PCS includes data on CSO permits but lacks data on location of outfalls for most permits. EPA is currently working with the regions and states to develop an approach for including and maintaining CSO outfall locations within the existing PCS framework. While PCS is a tool for EPA and state use only, public data are made available through EPA's Envirofacts website <http://www.epa.gov/enviro/>, which provides a single point for accessing EPA's facility dataset.

National Assessment Database (NADB) - <http://www.epa.gov/305b/2000report/>

The National Assessment Database contains information on the attainment of water quality standards. Assessed waters are classified as "fully supporting," "threatened," or "not supporting," their designated uses. This information is reported in the NWQI Report to Congress under Section 305(b) of the Clean Water Act. Analyses presented in this report use EPA's 2000 NWQI Report to Congress and the NHD-referenced data as means of assessing areas downstream of CSO outfalls.

Water Quality Standards Database (WQSDB) - <http://www.epa.gov/wqsdatabase/>

The WQSDB contains information on the designated uses for waterbodies. Designated uses set a regulatory goal for the waterbody, define the level of protection assigned to it, and establish scientific criteria to support that use. While not directly used for this report, the WQSDB provides supporting reference and data for EPA's 305(b) NWQI.

303(d) Total Maximum Daily Load (TMDL) Tracking System - <http://www.epa.gov/tmdl/>

The TMDL Tracking System contains information on waters that are not supporting their designated uses. These waters are listed by the state as impaired under Section 303(d) of the Clean Water Act. The status of TMDLs is also tracked. This report uses the April 1, 2002 NHD-referenced data to consider 303(d) listed waters downstream of CSO outfalls and to examine TMDLs in place for those areas.

Safe Drinking Water Information System (SDWIS)

The Safe Drinking Water Act requires that states report information to EPA about public water systems, including violations of EPA's drinking water regulations. The Safe Drinking Waters Act regulations and their enabling statutes establish maximum contaminant levels, compliance guidelines, and monitoring and reporting requirements to ensure that water provided to customers is safe for human consumption. This information is stored in SDWIS. Data as of June 25, 2003, was provided by EPA's Office of Ground Water and Drinking Water in an NHD-referenced format to facilitate comparison with known CSO outfall locations.

National Shellfish Register of Classified Growing Waters

The classification of shellfish-growing waters is based on the National Shellfish Sanitation Program (NSSP), a cooperative effort involving states, the shellfish industry, and the FDA. Since 1983, it has been administered through the Interstate Shellfish Sanitation Conference (ISSC). The ISSC was formed to promote shellfish sanitation, adopt uniform procedures, and develop comprehensive guidelines to regulate the harvesting, processing, and shipment of shellfish. In 1995, the NSSP and coastal states listed over 33,000 square miles of marine and estuarine waters as classified shellfish-growth areas and published the coverage for distribution in ArcGIS geographically referenced areas. The areas are very site-specific and not a part of a hydrography network. Nonetheless, the data were easily linked to nearby CSO outfalls via standard ArcGIS geoanalysis detailed later in this appendix.

F.5 Technical Approach

The technical approach taken to link a digital CSO outfall dataset to other EPA data and program assessments is summarized below. The key activities undertaken for this effort include converting CSO outfall data to a spatially referenced digital format, relating the outfall locations to the NHD, and using the NHD stream network to look at areas at and downstream of the CSO outfalls through comparative analysis of other EPA data referenced to the NHD. EPA maintains program data including 303(d) lists, 305(b) assessments, and drinking water intake data linked to the NHD in its Reach Address Database (RAD). RAD provides the linkage from EPA datasets to the NHD referenced water reaches. EPA's Watershed Assessment, Tracking, & Environmental Results (WATERS) initiative serves as a common platform for linking data from all of EPA's surface water programs. These relationships are discussed in more detail below.

National Hydrography Database (NHD) - <http://nhd.usgs.gov/>

NHD is a nationally consistent hydrography dataset for the United States. A culmination of recent cooperative efforts between EPA and USGS, it combines elements of USGS digital line graph hydrography files and the EPA Reach File (RF3). NHD is designed to serve three simultaneous functions for surface waters:

1. Provide a standard unique identifier (reach code) for each part of the surface water network. Reach codes act like street addresses in a road network, providing a unique identifier for streams and other waterbodies.
2. Contain a tabular routing (navigation) network of these features.
3. Include a digital map representation of these features.

The analyses conducted for this report use the three functions of NHD. With NHD, CSO outfall locations are described by reach, the network is used to examine downstream conditions, and a visual representation of the locations and downstream pathway is given.

NHD is currently available in 1:100,000 (1:100K) scale format from USGS for the continental United States. Although some states are moving to higher resolution representations of their waters (e.g., the 1:24,000 (1:24K) scale), the 1:100,000 scale NHD was used for the analyses presented in this report.

Reach Address Database (RAD) - <http://www.epa.gov/waters/about/rad.html>

EPA's RAD stores program data linked to NHD reaches, including information on the spatial extent of various program data. Datasets in RAD include, but are not limited to, the 303(d) and 305(b) programs. RAD stores only locational information for stream addresses (i.e., position of the listing within the NHD reach network). The details of that reach, such as designated use, monitoring results, assessment scores, or impairment type, remain in the program database. This report uses RAD as the gateway for linking CSO outfalls referenced to NHD with other EPA program data.

Reach Index and Reach Navigation of the Digital CSO Outfalls

A Reach Indexing Tool (RIT) was used to designate CSO outfall locations to the nearest point of an NHD reach, creating a CSO outfall stream address. These data were transferred to the RAD to provide instant linkage to other RAD program data. In order to access the other data, the CSO outfall addresses were then 'reach walked' to other RAD data. The reach walk is a service available within the WATERS system that allows upstream or downstream navigation of the NHD network, and thus a traverse of any data in the RAD/WATERS system. The reach walk was conducted to provide information on the distance between the CSO outfall stream address and other EPA

program data within RAD.

Downstream Analysis, Impacts, and Pollutants of Concern

For analysis of the reach walked NHD data, a downstream distance of one mile was considered to be a point where CSO impacts would be most discernable. Where pollutant or stressor information was available, the primary pollutants found in CSOs (pathogens, solids (TSS), and oxygen-demanding organic materials measured as BOD₅) were included in the analysis.

F.6 Analysis and Results

305(b) Analysis and 303(d) Analysis

Electronic data were available via WATERS within the RAD framework for 305(b) (assessment) and 303(d) (listing) information, as part of the Clean Water Act requirements. While 303(d) listed waters were available electronically for all states except Alaska, electronic 305(b) assessments were available for 13 of the 32 CSO states (as shown in Figure F.2). Data comparisons were made only for states where data were available.

State assessed waters within one mile downstream of CSO outfalls were evaluated. Waters in that distance with a cited impairment (pathogens, sediment/siltation, and organic enrichment causing low dissolved oxygen) were further examined. For example, existing TMDLs were reviewed to explore the relationship between impairment and source load allocation, including CSOs, as part of the existing TMDL. The tables on the next page summarize the findings.

Figure F.2 CSO States with Electronic NHD-Indexed 305(b) Assessed Waters

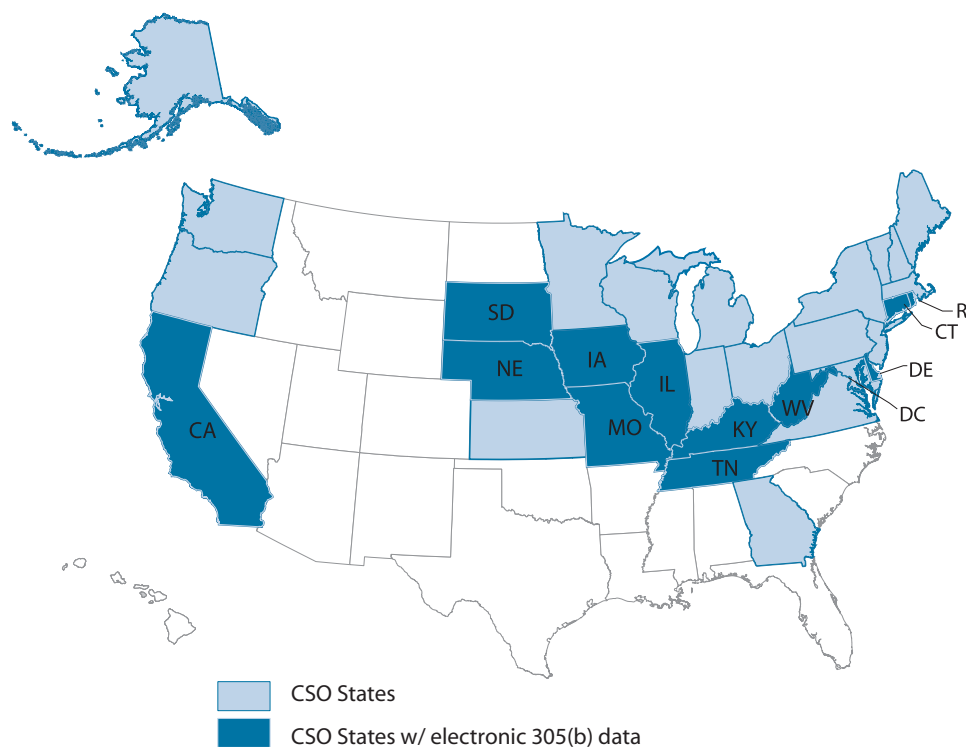

Table F.2 Waters Considered in this Analysis

	# of NHD Reaches
In CSO States	1,495,853
within 1 mile downstream of a CSO Outfall	1,560

Table F.3 2000 NWQI Assessment within 1 mile of CSO Outfall

Assessed Waters	Total Assessed	Assessed as Good	Assessed as Impaired	Percent Impaired
Assessed 305(b) segments in CSO states with electronic 305(b) data	59,335	44,457	14,878	25%
Assessed segments within one mile downstream of a CSO outfall	733	181	552	75%

Table F.4 303(d) Listed Waters by Cause Categories aligning with impacts from CSOs

Listed Waters	Reason or Cause of Listing		
	Pathogens	Enrichment Leading to Low Dissolved Oxygen	Sediment and Siltation
Total number of listed waters in CSO states	3,446	1,892	3,136
Number of listed waters within one mile of a CSO outfall	191	163	149

Drinking Water Analysis

The SDWIS database and the CSO database were geospatially cross-referenced using the NHD. The location of drinking water intakes downstream of a CSO was determined and their proximity was assessed.

The database was queried selecting the drinking water intakes within one mile of a CSO outfall. Phone interviews were conducted with both the NPDES and drinking water authorities for cities with CSOs located within one mile upstream of a drinking water intake to confirm the location of the CSO outfall, whether the CSOs are active, and the location of the drinking water intake. Two facilities were eliminated from the analysis because their drinking water intake or their CSO outfalls were not located within the one-mile analysis radius. The results of this analysis are summarized in Table F.5.

Table F.5 Association of CSO Outfalls with Drinking Water Intakes

EPA Region	State	CSO Outfalls within 1 Mile Upstream of a Drinking Water Intake
1	ME	7
2	NY	7
3	PA	19
3	WV	9
4	KY	7
5	IN	3
5	OH	7
Total:		59

Note: EPA was unable to confirm data for an additional 14 outfalls in two states (PA and WV); these outfalls are not included in this table.

Classified Shellfish-Growing Areas Analysis

Classified shellfish-growing areas are not georeferenced to the NHD. The geographic coverage available from NOAA provides spatial locations of the shellfish-growing areas and associated attribute data. The attribute data include information such as the shellfish classification and suspected sources of pollution including wastewater treatment plants and CSOs.

Given the geospatial location of the CSOs and shellfish-growing areas, it is possible to analyze the distance between the two datasets using a buffer. A buffer creates an area around a geospatial dataset for a specified distance. It is then possible to intersect the buffer with another dataset to determine if they coincide spatially. This buffer process was used to determine how many CSOs are located within five miles of a shellfish-growing area. The results of this analysis are summarized in Table F.6 below.

Table F.6 Classified Shellfish-Growing Areas Within Five Miles of a CSO Outfall

Shellfish Harvest Classification	Number of Classified Shellfish Growing Areas within 5 Miles of a CSO outfall
Prohibited	411
Restricted	80
Approved	154
Unclassified	14
Total	659

Appendix G

National Estimate of SSO
Frequency and Volume

G.1 Summary

National estimates of SSO frequency and volume were generated based on reporting data for more than 33,000 SSO events provided by 25 states during calendar years 2001, 2002, and 2003. The discussion of SSOs in this report does not account for discharges from points after the headworks of the treatment plant, regardless of the level of treatment, or backups into buildings caused by problems in the publicly-owned portion of the SSS. Therefore, these estimates of SSO volume and frequency do not account for discharges occurring after the headworks of the treatment plant or backups into buildings. Estimates were generated by extrapolating these data across the remaining 25 states and Washington, D.C., through a five-step procedure:

1. **Tabulate the total number of SSO events and the SSO volume for each of the reporting states.**
2. **Estimate the total number of SSO events per year for each non-reporting state** based on the number of sewer systems in the state or the population served by sewer systems in the state.
3. **Divide the total number of events in each non-reporting state into different categories describing the cause of the SSO event** based on observed regional differences among the 25 reporting states.
4. **Calculate the SSO volume for each cause category in each non-reporting state** to account for observed regional differences.
5. **Calculate national estimates** by summing the total number of events by state and the total volume across all states.

A range of estimates corresponding to different assumptions regarding the nature of the reported data was generated. Results of the analysis indicate that the annual frequency of SSO events is between 23,000 and 75,000 events per year, with a corresponding volume of 3 to 10 billion gallons per year. This relatively large range is due to uncertainty regarding the extent to which the reported SSO events reflect all SSO events that occurred during calendar years 2001, 2002, and 2003.

This appendix summarizes how the estimates of SSO frequency and volume were generated. The discussion is grouped into the following sections:

- Data available
- Assumptions
- Results
- Initial data assessment
- Calculation procedure

G.2 Data Available

The national estimates of SSO frequency and volume were based on data provided by 25 states over three years (January 1, 2001 to December 31, 2003). Data were provided by:

- California
- Colorado
- Connecticut
- Florida
- Georgia
- Hawaii
- Indiana
- Kansas
- Maine
- Maryland
- Massachusetts
- Michigan
- Minnesota
- New Hampshire
- Nevada
- North Carolina
- North Dakota
- Oklahoma
- Rhode Island
- South Carolina
- South Dakota
- Utah
- Washington
- Wisconsin
- Wyoming

These data were obtained directly from the NPDES authority in each of these states. Data were typically compiled in either a database or spreadsheet. Specific data elements tracked by NPDES authorities are summarized in Table G.1.

Table G.1 Data Elements Tracked by NPDES Authorities with Electronic Systems

State	Date & Time Reported	Start Date & Time	End Date & Time/Duration	Total Overflow Volume (gallons)	SSO Location ^a	SSO Cause	Response Measures Taken ^b	Receiving Water Identified
CA	●	●	●	●	●	●	●	●
CO	●	●	●	●	●	●	●	●
CT		●	●	●	●	●		
FL		●		●	●	●		●
GA	●	●		●	●			●
HI	●	●	●	●	●	●	●	●
IN		●	●	●	●	●		
KS		●	●		●			
MA	●	●	●	●	●	●	●	●
MD		●	●	●	●	●		●
ME	●	●	●	●	●	●	●	●
MI	●	●	●	●	●	●	●	●
MN	●	●	●	●	●	●	●	
NC		●	●	●	●	●		●
ND	●	●	●	●		●	●	●
NH	●	●	●	●	●	●	●	●
NV	●	●		●	●	●	●	●
OK		●	●	●	●	●	●	
RI	●	●	●	●	●	●	●	●
SC	●			●	●			●
SD	●	●	●	●	●	●	●	●
UT						●		
WA		●		●	●	●	●	●
WI		●	●	●	●	●	●	●
WY		●				●	●	●

^a May not include exact SSO location point

^b May include cleanup activities, volume recovered, and corrective or preventive measures

A total of 36,325 SSO event records were collected from the NPDES authorities and compiled into a single data management system. No attempt was made to verify the quality or accuracy of the data with the individual jurisdictions reporting the SSOs; however, a quality check of the data was performed to identify discrepancies (e.g., gallons versus million gallons, dates outside of the 2001-2003 range, and records with no dates). Reported events with missing event volumes were used to generate frequency estimates, but were not used for volume

estimates. Reported events with dates outside of the 2001-2003 range and events with no dates were not used to estimate SSO frequency or volume. After the screening, a total of 33,213 records remained describing event frequency, and 28,708 records remained describing event volumes.

Some states did not provide data for the entire three-year period. SSO frequency data for these states were adjusted proportionally to account for the missing months. For example, the number of observed events for a state providing 21 months of reports out of the 36-month period were scaled up by a factor of 36/21.

Basic information describing the sewerage universe in each state was obtained from the 2000 CWNS and included:

- Total number of collection systems by state
- Number of SSSs by state
- Population served by SSSs by state

Lastly, data for each state were grouped by EPA Region to facilitate analysis of regional differences. The number of SSSs and the population served are presented by Region in Table G.2.

Table G.2 Number of SSSs and the Population Served by the SSSs for each Region

EPA Region	Total number of SSSs	Population served by SSSs (in millions)
1	705	6.18
2	1,518	14.51
3	2,149	15.49
4	2,678	29.89
5	4,296	27.05
6	2,983	25.67
7	2,619	7.58
8	1,437	7.78
9	1,003	33.38
10	823	6.36

G.3 Initial Data Assessment

Several analyses were conducted to assess the data prior to estimating SSO frequency and volume. The initial data assessment included:

- Analysis of climatic conditions
- Analysis of the variability of discharge volume, number of systems reporting at least one event, population served, and SSO event frequency
- Regional characterization of frequency, volume, and cause category
- Analysis of volume discharged by cause category
- Statistical regressions to predict frequency of events for non-reporting states

These analyses are discussed in more detail below.

Analysis of Climatic Conditions

Annual precipitation statistics developed by the National Climatic Data Center (NCDC) suggest that no obvious bias towards wet or dry conditions was observed. Climatic conditions in the reporting states over the three-year period ranged from record drought to record rainfall. The results of NCDC’s analysis for 2001-2003 are presented in Table G.3 for the 24 of the reporting states. Data for Hawaii were not available.

Table G.3 National Precipitation Summary by State for 2001-2003

State	2001	2002	2003
CA	Near normal	Below normal	Near normal
CO	Near normal	Record driest	Below normal
CT	Below normal	Near normal	Much above normal
FL	Near normal	Above normal	Above normal
GA	Below normal	Near normal	Above normal
IN	Above normal	Above normal	Above normal
KS	Near normal	Below normal	Near normal
MA	Near normal	Near normal	Much above normal
MD	Much below normal	Near normal	Record wettest
ME	Record driest	Near normal	Near normal
MI	Much above normal	Near normal	Near normal
MN	Above normal	Above normal	Below normal
NC	Much below normal	Near normal	Record wettest
ND	Near normal	Below normal	Below normal
NH	Much below normal	Near normal	Above normal
NV	Near normal	Much below normal	Near normal
OK	Near normal	Near normal	Below normal
RI	Near normal	Near normal	Above normal
SC	Much below normal	Near normal	Above normal
SD	Above normal	Below normal	Near normal
UT	Near normal	Much below normal	Near normal
WA	Near normal	Below normal	Near normal
WI	Above normal	Above normal	Below normal
WY	Below normal	Much below normal	Below normal

Analysis of Variability

The first data assessment step was to statistically characterize the variability in the parameters used to generate the national estimates. The first parameter evaluated was SSO event discharge volume. A frequency distribution was generated for the reported volume data and goodness-of-fit tests were conducted to determine the type of statistical distribution that the data exhibited. The volume distribution was reasonably described with log-normal distributions.

Three additional parameters related to event frequency were investigated, and each was characterized with a single value for each state. The parameters were: 1) number of systems with events; 2) population served; and 3) number of events per year. Frequency distributions were generated for each of these parameters and goodness-of-

fit tests were conducted to determine the type of statistical distribution. Log-normal distributions were found to adequately describe each parameter.

Regional Characterization

The data for SSO frequency, volume, and cause were stratified by EPA region to determine if geographical differences in SSO characteristics existed. The cause of SSO events was found to vary significantly by region. Box and whisker plots were initially generated to provide a visual depiction of differences in volume by region. Analysis of variance (ANOVA) testing was then conducted to verify that significant differences existed between regions. Once these differences were confirmed, additional Bonferroni-adjusted ANOVA testing was conducted to identify individual differences between regions. Analyses were conducted on log-transformed data, consistent with the determination of log-normality discussed earlier. Based on these results, all subsequent analyses for cause category were conducted on a region-specific basis. State-specific cause information was used for the 25 states in EPA's data management system. Distributions for SSO cause were developed and applied by region to states without state-specific information in EPA Regions 1, 3, 4, 5, 9, and 10. One average cause distribution was used for Regions 6, 7, and 8 because the cause of SSO events reported by the states in these regions was very similar. Finally, none of the 25 states in EPA's data management system are in EPA Region 2, so an average cause distribution was developed and applied from the reporting states in Regions 1, 3 and 5. The cause distributions, by region, for non-reporting states are summarized in Table G.4.

Table G.4 Percentage of SSO Events, by Cause, by Region

Region	Blockage	Line Break/Misc.	Mechanical/Power Failure	Wet Weather – I/I	Unknown
1	41%	13%	10%	30%	6%
2	25%	12%	11%	36%	17%
3	36%	13%	7%	13%	30%
4	34%	11%	7%	12%	35%
5	8%	10%	16%	58%	8%
6	48%	9%	7%	21%	15%
7	48%	9%	7%	21%	15%
8	48%	9%	7%	21%	15%
9	69%	15%	6%	1%	9%
10	22%	13%	16%	6%	43%

Less significant regional differences were observed for SSO event frequencies and the volume of individual spills; therefore, subsequent analyses regarding SSO event frequencies and volumes were not stratified on a regional basis.

Analysis of Volume Discharged by Cause Category

The next data assessment step was to determine whether a relationship existed between volume discharged and cause of the SSO event. SSO volumes were found to vary significantly across most cause categories. Box-and-whisker plots were generated to provide a visual depiction of differences in volume by cause category. No significant differences in volume discharged were observed across the cause categories of Line Break and Miscellaneous. These two categories were therefore combined into a single category, as shown in Table G.4. ANOVA testing was conducted to verify that significant differences existed between the remaining categories. Once these differences were confirmed, additional Bonferroni-adjusted ANOVA testing was conducted to identify

individual differences between cause categories. Analyses were conducted on log-transformed data, consistent with the determination of log-normality discussed earlier.

Statistical Regression to Estimate SSO Frequency

In order to estimate national SSO frequency, the frequency data from the reporting states were extrapolated to estimate the non-reporting states. For this final data assessment step, a series of linear regressions were developed allowing event frequencies to be estimated for each state. Several regressions (both in linear and log-log space) were conducted to evaluate potential predictors of event frequency. The independent variables evaluated were:

- Number of SSSs in the state reporting at least one SSO event
- Total number of SSSs in the state
- Population served by SSSs in the state

Based upon these analyses, the two best predictors of event frequency were:

- 1) Log-log regression of number of SSO events per year as a function of the number of SSSs in the state with events, linked to a second regression of number of SSSs in the state reporting at least one SSO event with events, as a function of total number of SSSs in the state; and
- 2) Log-log regression of number of events per year as a function of total population.

Both methods provided a similar level of accuracy, explaining approximately 40 percent of the variability in the observed frequency data; therefore, both the system-based and population-based methods were used in generating the national estimates.

G.4 Assumptions

Estimating the national SSO frequency and volume from available data required a number of assumptions. The two primary assumptions that have the greatest potential to affect the estimates are:

- The degree to which reported SSO events in a specific time period represent all SSO events that occurred statewide during the same period; and
- The degree to which the number of SSSs in a state serves as a predictor of SSO frequency and volume, compared to population served.

To account for the uncertainty caused by these assumptions, separate analyses were conducted using a range of values. The range of results obtained from these alternative analyses helps to bound the uncertainty in the estimates generated.

Scenarios Evaluated

Different assumptions can be made regarding the degree to which the reported data represent statewide conditions. It could be assumed that each state's reporting data reflect all SSO events that occurred in that state. Alternatively, it could be assumed that the data reflect SSO events that occurred only for those communities that chose to report SSO events. It is not clear at this time which of these assumptions is most appropriate. To account for the uncertainty caused by these alternate assumptions, two separate scenarios were simulated:

- Scenario 1: Available reporting data reflect all SSO events that occurred statewide
- Scenario 2: Available reporting data reflect events that occurred for only those communities that chose to report

These scenarios were further evaluated using two different predictors of SSO frequency for states that do not track SSOs electronically:

- Predictor a: Event frequency based on total number of separate sewer systems in state
- Predictor b: Event frequency based on population served by separate sewers in state

The two pairs of assumptions discussed above result in four possible combinations of scenarios: 1a, 1b, 2a, and 2b. Scenario 2b, however, could not be evaluated as it requires data on population served by separate sewers in each municipal jurisdiction reporting at least one SSO event. These data were available only on a statewide basis. Consequently, only three scenarios were evaluated: 1a, 1b, and 2a.

G.5 Calculation Procedure

National estimates of SSO frequency and volume were generated by extrapolating the available data across the remaining 25 states (and Washington, D.C.) through the following five-step procedure:

1. Tabulate the total number of SSO events and the SSO volume for each of the reporting states.
2. Estimate the total number of SSO events per year for each non-reporting state.
3. Divide the total number of SSO events in each non-reporting state into different categories describing the cause of the SSO event.
4. Calculate the SSO volume for each cause category in each non-reporting state.
5. Calculate national estimates by summing across all states.

Step 1. Data Tabulation

Data tabulation was described earlier.

Step 2. Estimate total number of SSO events per year for each state

The total number of SSO events per state was calculated for all three scenarios. Scenarios 1a and 1b assume that the available reporting data reflect all SSO events statewide, so the reported frequencies were not adjusted when calculating frequencies for the non-reporting states. Scenario 2a assumed that the available reporting data reflect only those communities that choose to report. For Scenario 2a estimates, the expected frequencies were scaled upward to represent the ratio of separate sewer systems reporting SSO events to the total number of sewer systems. Non-reporting communities in each state were assumed to experience SSOs in a frequency distribution that matched the reporting communities.

Step 3. Divide total number of SSO events into respective cause categories

The initial data assessment calculated the relative frequency of the cause of SSO events by EPA region. Region-specific ratios are applied in Step 3 to define the number of events by cause category for each non-reporting state, as presented in Table G.4.

Step 4. Calculate SSO volume for each cause category

The initial data assessment defined SSO event volume as a function of cause. These region-specific cause and cause-specific volumes were applied in Step 4 to the frequency of events to define the total volume of SSO by cause category for each of the non-reporting states.

Step 5. Calculate national estimates

SSO event frequency and cause-specific volumes for each non-reporting state were generated in Steps 2 through 4. These estimates were combined with the data from the reporting states and were summed to provide a national estimate of SSO frequency and volume for each of the three scenarios examined.

G.6 Results

The results of the analyses for each of the three scenarios are summarized in Table G.5. These results indicate that the annual frequency of SSO events is between 23,000 and 75,000 events per year, with a corresponding volume of 3 to 10 billion gallons per year. The methodology used in developing this estimate results in an average volume per spill of approximately 125,000 gallons, while the average volume per spill in EPA’s data management system is approximately 94,000 gallons per spill. This occurs as a direct result of a methodology that accounts for regional differences in the cause of SSO events. Of the six states with the highest populations and numbers of systems that did not provide data for this analysis, five (IL, NJ, NJ, OH, and PA) are in areas of the country where higher volume wet weather SSO events are more common.

The relatively large range is due to the uncertainty regarding the extent to which communities reporting at least one SSO event reflect all communities that had an SSO event, as the differences between Scenario 1a and Scenario 2a are much greater than the differences between Scenario 1a and Scenario 1b. Absence of a Scenario 2b does not seem to affect the overall range. As seen for Scenario 1, the population-based estimates are lower than the systems-based estimates. This suggests that Scenario 2a would be greater than Scenario 2b. It is important to note that the ranges provided in Table G.5 are not necessarily all-encompassing, as the estimates contain additional assumptions that could either raise or lower the values provided. For example, this estimate assumes that reporting communities report every SSO event that occurred within their community; that is, no SSO event went unnoticed and unreported. If reporting communities failed to report any number of their SSO events, the estimates provided in Table G.5 would underestimate the true frequency and volume of SSOs. The estimate also assumes that non-reporting communities have SSOs in the same frequency distribution as reporting communities; this assumption could over-estimate the frequency and volume of SSOs for non-reporting communities. There is no way to quantify the significance of these types of assumptions, but the uncertainty introduced by these assumptions is anticipated to be small compared to the variability already considered in the analysis. Further, EPA believes that the alternative assumptions are more likely to affect SSO event frequency, rather than volume estimates.

Table G.5 National Estimates of SSO Frequency and Volume

Scenario	Estimated Number of Events per Year	Estimated SSO Volume (billion gallons)
Scenario 1a– systems based	24,564	3.06
Scenario 1b– population based	23,103	2.85
Scenario 2a– systems based	74,813	9.74

Appendix H

Estimation of SSO Impacts in
Streams and Rivers

H.1 Introduction

The often unpredictable nature of SSO events can make it difficult to monitor and collect the data needed to measure the occurrence and severity of any attendant environmental impacts. In the absence of specific national data on the location of SSOs and the environmental impacts caused by SSOs, EPA applied statistical methods and a simple dilution model to estimate environmental impacts. Estimated impacts were approximated with respect to violations of water quality standards for bacteria.

This analysis is intended to provide a broad, initial assessment of environmental impacts that might be expected when SSOs discharge to waterbodies across the nation. The analysis is based upon the distribution of observed SSO volumes described in Chapter 4, typical concentrations of bacteria in dilute and more concentrated wastewaters, and varying receiving water flow rates. This appendix documents the methodology EPA used in this analysis.

H.2 Technical Approach

As described in Section 4.7 of this report, EPA was able to compile a substantial amount of information on the frequency, volume, and cause of SSO events. From these data, EPA also found nearly three-quarters of reported SSO events reach a surface water. This dataset was used to develop a frequency distribution characterizing typical SSO volumes. Using this national data, EPA applied a simple dilution model in an iterative manner to estimate the likely impact of SSO events on streams and rivers based on reasonable assumptions about SSO event duration, the concentration of bacteria in SSO discharges, and stream flow. For the purpose of this report, modeled impacts associated with SSO events were evaluated in terms of violations of the single sample maximum water quality criteria for fecal coliform (FC). That is, a predicted concentration of greater than 400 counts per 100 mL would be considered to be a water quality standards violation.

H.3 Description of Simple Model and Inputs

Application of the simple dilution model to assess environmental impacts in terms of exceedance of a single sample maximum water quality criteria for fecal coliform is described as follows:

1. Individual SSO volumes were generated using the statistical distribution of reported SSO values as described in Chapter 4.
2. The duration of SSO events was developed from a distribution of reported SSO durations.
3. Monte Carlo techniques were applied to generate hundreds of thousands of SSO volume and duration combinations that were used as input to the simple dilution model.
4. Three concentrations of fecal coliform were used to represent dilute, medium strength, and concentrated SSO discharges.
5. The model was run under three different scenarios: one that assumed the entire volume of each modeled SSO discharge reached a surface water (100% delivery), a second that assumed half the volume of each modeled SSO discharge reached a surface water (50% delivery), and a third that assumed 10 percent of the volume of each modeled SSO discharged reached a surface water (10% delivery).
6. SSO loads were delivered to receiving waters with a range of stream flow rates.
7. A simple mass-balance calculation was applied where the instream concentration is a function of SSO volume, SSO duration, SSO concentration, and stream flow.
8. Results were grouped by receiving water stream flow rate.

This model includes the following simplifying assumptions:

- Upstream flow was assumed to be free of fecal coliform (i.e., no background fecal coliform in the upstream water) to isolate SSO impacts.
- The decay of fecal coliform bacteria was not simulated.

Additional information on specific model inputs is summarized below:

SSO volume

Direct characterization of SSO event data is limited to a frequency distribution of overflow volume. The dilution model presented herein is based on analysis of reported SSO data. Volumes for SSO (V_{SSO}) events in gallons are taken from a transformed normal distribution:

$$V_{SSO} = -1/\text{Min}(-0.4343, N(-0.729383, 0.086845))^{22.222222}$$

SSO Duration

The dilution model calculation expects pollutant loads to be expressed in terms of flow (volume per time) and concentration (mass per volume). Based on analysis of duration data provided by the states, the estimation model assigns durations in hours (T_{SSO}) selected from a log-normal distribution:

$$T_{SSO} = \text{Max}(2, e^{\text{Min}(6, N(1.081, 1.344))})$$

SSO Fecal Coliform Concentration

The estimation considers the impacts on streams of three representative fecal coliform concentrations:

- Dilute wastewater, with a fecal coliform concentration of 500,000 counts per 100 mL (typical for a wet weather SSO).
- Medium strength wastewater, with a fecal coliform concentration of 10,000,000 counts per 100 mL (middle range for dry-weather SSOs).
- Concentrated wastewater, with a fecal coliform concentration of 1,000,000,000 counts per 100 mL (upper range for dry-weather SSOs).

The decay of fecal coliform bacteria was not included because the analysis was limited to the point of mixing where impacts are likely greatest, and did not consider effects, if any, as the bacteria moved downstream.

Delivery Ratio

The location of SSOs with relation to receiving waters is not available. Further, EPA has no information about the percentage of the volume that reaches a receiving water for a particular event. For this reason, the model was run under three delivery scenarios: 10 percent, 50 percent, and 100 percent of the volume of each modeled SSO discharge.

Stream Types and Upstream Flow

The simple dilution model looks at the impact of a given SSO event that is characterized by estimated volume, duration, and concentration on waterbodies with different flow rates. The flow rates represent the range of flow conditions found in stream reaches within U.S. Impacts of individual SSO events are calculated for each flow rate.

All receiving waters were assumed to have good water quality upstream of the point where SSO discharges are delivered. That is, the ambient fecal coliform concentration was assumed to be zero. As a result, the estimate quantifies only those water quality standards violations caused solely by SSOs, absent background levels and contributions from other sources.

Simple Dilution Model

The simple dilution model consists of a mass-balance calculation where the instream concentration is a function of SSO volume, SSO duration, SSO concentration, and upstream flow:

$$C = C_{SSO} * ((V_{SSO}/T_{SSO}) / (Q + (V_{SSO}/T_{SSO})))$$

where:

C = resulting instream concentration of fecal coliform in counts/100mL

C_{SSO} = concentration fecal coliform in the SSO in counts/100mL

V_{SSO} = volume of individual SSO event in cf (converted from gallons)

T_{SSO} = duration of the SSO event in seconds (converted from hours)

Q = upstream flow in cfs

Using Monte Carlo techniques, percentages of exceedances (C > 400 counts per 100 mL) were tracked for 100,000 different simulated SSO events for three different SSO concentrations across each of the stream classifications.

H.4 Results

As shown in Table H.1, the potential impact of a particular SSO event is tied to the flow in the receiving water at the time this discharge occurred as well as to the strength of the wastewater discharged and the amount reaching the receiving water. No comparable analysis of SSO discharges to lakes or estuarine waters was undertaken.

Table H.1 Estimated Percentage of Time SSOs Would Cause Water Quality Standards Violations in Varying Sizes of Receiving Waters

Flow Rate (cfs)	Dilute Wastewater (FC = 500,000 #/ml)			Medium Strength Wastewater (FC = 10,000,000 #/100 ml)			Concentrated Wastewater (FC = 1,000,000,000 #/ml)		
	10% Delivery	50% Delivery	100% Delivery	10% Delivery	50% Delivery	100% Delivery	10% Delivery	50% Delivery	100% Delivery
50	12%	27%	36%	45%	68%	77%	95%	99%	100%
100	9%	20%	27%	36%	58%	68%	92%	98%	99%
250	5%	12%	18%	25%	45%	55%	84%	95%	97%
500	3%	9%	12%	18%	36%	45%	77%	92%	95%
1000	2%	6%	9%	13%	27%	36%	68%	86%	92%
5000	1%	2%	3%	5%	13%	18%	45%	68%	77%
10000	0%	1%	2%	3%	9%	13%	36%	58%	68%

Appendix I

Human Health Addendum

- I.1 Selected Waterborne Disease Outbreaks Documented by the Center for Disease Control and Prevention

- I.2 Interviewed Communities' and States' Roles and Responsibilities Matrix

- I.3 Selected Case Studies

- I.4 Documented Concentrations of Bacteria, Enteric Viruses, and Parasitic Protozoa in Sewage

I.1 Selected Waterborne Disease Outbreaks Documented by the Center for Disease Control and Prevention

The CDC routinely publishes reports of waterborne disease outbreaks as part of their *Mortality and Morbidity Weekly Report Surveillance Summaries*. These reports include incidents of waterborne disease contracted through exposure to contaminated recreational waters or consumption of contaminated drinking water, fish, or shellfish. EPA compiled reports from the *Surveillance Summaries* for etiologic agents that are known to be present in untreated wastewater; however, in doing so EPA does not intend to imply that all outbreaks listed in the following tables are related to untreated wastewater or CSO or SSO discharges. Outbreaks are indicated in **bold** when untreated wastewater was specifically identified by the CDC as contributing to the outbreak.

Table I.1 Selected Outbreaks from Exposure to Contaminated Drinking Water

Etiologic Agent	Cases	State(s)/Territory	Year	Type of Source Water
<i>Salmonella typhi</i>	60	Virgin Islands	1985	Suspected cross connection between water and sewer line.¹
<i>Giardia</i>	12	Maine	1986	River ²
Acute Gastrointestinal Illness (AGI)	36	New Mexico	1986	River ²
<i>Giardia</i>	44	New York	1986	Lake ²
<i>Campylobacter</i>	250	Oklahoma	1986	Lake ²
<i>Giardia</i>	68	Vermont	1986	River ²
AGI	71	New Hampshire	1987	Lake ²
<i>Giardia</i>	513	Pennsylvania	1987	River ²
AGI	1,400	Puerto Rico	1987	Community water supply. ²
<i>Shigella sonnei</i>	1,800	Puerto Rico	1987	Contamination of a reservoir with sewage following a rain event and power failure.²
Norwalk-like virus	5,000	Pennsylvania, Delaware, and New Jersey	1987	For cases in Pennsylvania and Delaware, outbreak is due to commercially manufactured ice produced from a contaminated water well. The outbreak in New Jersey is also from ice from a contaminated water well. ²
<i>Cryptosporidium</i>	13,000	Georgia	1987	River ²
<i>Giardia</i>	90	Colorado	1988	River ²
AGI	7	Colorado	1988	River ²
<i>Giardia</i>	172	Pennsylvania	1988	Lake ²
Norwalk-like virus (Setting: Resort)	900	Arizona	1989	Outbreak due to "effluent from sewage treatment facility seeping directly into resort's well through cracks in the subsurface rock."³
<i>Giardia</i>	19	Colorado	1989	River ³
AGI	31	Idaho	1989	Untreated surface water from a lake. ³
<i>Giardia</i>	308	New York	1989	Reservoir ³
<i>Giardia</i> (Setting: Prison)	152	New York	1989	Treatment deficiencies for drinking water from a reservoir. ³

Table I.1 continued

Etiologic Agent	Cases	State(s)/Territory	Year	Type of Source Water
<i>Giardia</i>	53	New York	1989	Lake ³
<i>E. coli</i> O157:H7	243	Missouri	1989	SSO contamination of municipal drinking water well. This outbreak resulted in four deaths.³
<i>Giardia</i>	18	Alaska	1990	River ³ (Setting: Lodge)
AGI	109	Missouri	1990	Lake ³
AGI	63	Pennsylvania	1990	Lake ³ (Setting: Inn)
<i>Giardia</i>	24	Vermont	1990	Lake ³ (Setting: Resort)
AGI	202	Puerto Rico	1991	Deficiency with penitentiary distribution system for drinking water taken from a river. ⁴
AGI	9,847	Puerto Rico	1991	River ⁴
AGI	250	Minnesota	1992	Lake ⁴
<i>Giardia</i>	80	Nevada	1992	Lake ⁴
<i>Cryptosporidium</i>	3,000	Oregon	1992	Wastewater discharges and low flow in a river used for drinking water.⁴
AGI	28	Pennsylvania	1992	River ⁴
<i>Cryptosporidium</i>	27	Minnesota	1993	River ⁵
<i>Cryptosporidium parvum</i>	103	Nevada	1993	Lake ⁵
<i>Cryptosporidium parvum</i>	403,000	Wisconsin	1993	Treatment deficiencies and decline in raw water quality. ⁵
<i>Giardia lamblia</i>	20	Pennsylvania	1993	Well contaminated with sewage.⁵
<i>Giardia lamblia</i>	18	New Hampshire	1994	Reservoir ⁵
<i>Giardia lamblia</i>	36	New Hampshire	1994	Lake ⁵
<i>Giardia lamblia</i>	304	Tennessee	1994	Reservoir ⁵
<i>Cryptosporidium parvum</i>	134	Washington	1994	Well contaminated with wastewater. ⁵
<i>Giardia lamblia</i>	10	Alaska	1995	Surface water contaminated by unknown source. ⁶
<i>Giardia lamblia</i>	1,449	New York	1995	Lake ⁶
Viral outbreak (small, round-structured virus)	148	Wisconsin	1995	Lake ⁶
<i>Shigella sonnei</i>	83	Idaho	1995	Sewage leak contaminated drinking water well.⁶
<i>Giardia intestinalis</i>	50	New York	1997	Lake ⁷
AGI	123	New Mexico	1997	Sewage leak contaminated drinking water well.⁷
<i>Cryptosporidium parvum</i>	1,400	Texas	1998	Sewage spill contaminated drinking water wells.⁷
AGI	6	Florida	1999	River/Stream ⁸
AGI	4	Florida	1999	River/Stream ⁸
AGI	46	Washington	1999	River/Stream ⁸
<i>E. coli</i> O157:H7	5	California	2000	River/Creek ⁸
<i>Giardia intestinalis</i>	27	Colorado	2000	River/Creek ⁸
<i>Giardia intestinalis</i>	12	Minnesota	2000	Well contaminated with sewage.⁸
<i>Giardia intestinalis</i>	4	New Mexico	2000	River ⁸
Norwalk-like virus	123	West Virginia	2000	Well contaminated with sewage.⁸

¹Center for Disease Control (CDC). 1988. Water-Related Disease Outbreaks, 1985. *Morbidity & Mortality Weekly Report Surveillance Summaries*. 37 (SS-2): 16-17.

²CDC. 1990. Waterborne-Disease Outbreaks, 1986-1988. *Morbidity & Mortality Weekly Report Surveillance Summaries*. 39 (SS-1): 1-13.

³CDC. 1991. Waterborne-Disease Outbreaks, 1989-1990. *Morbidity & Mortality Weekly Report Surveillance Summaries*. 40 (SS-3): 1-21.

⁴CDC. 1993. Surveillance for Waterborne-Disease Outbreaks - United States, 1991-1992. *Morbidity & Mortality Weekly Report Surveillance Summaries* 42 (SS-5): 1-22.

⁵CDC. 1996. Surveillance for Waterborne-Disease Outbreaks - United States, 1993-1994. *Morbidity & Mortality Weekly Report Surveillance Summaries* 45 (SS-1): 1-33.

⁶CDC. 1998. Surveillance for Waterborne-Disease Outbreaks - United States, 1995-1996. *Morbidity & Mortality Weekly Report Surveillance Summaries* 47 (SS-5): 1-34.

⁷CDC. 2000. Surveillance for Waterborne-Disease Outbreaks - United States, 1997-1998. *Morbidity & Mortality Weekly Report Surveillance Summaries* 49 (SS-4): 1-35.

⁸CDC. 2002. Surveillance for Waterborne-Disease Outbreaks - United States, 1999-2000. *Morbidity & Mortality Weekly Report Surveillance Summaries* 51 (SS-8): 1-28.

Table I.2 Selected Outbreaks from Exposure to Contaminated Recreational Waters

Etiologic Agent	Number of cases	Location	Date	Type of Recreational Water
AGI	21	New York	1982	Diving in waters known to be contaminated with human sewage caused outbreak among New York City Police scuba divers.
<i>Shigella sonnei</i> and <i>boydii</i>	68	California	1985	Lake ²
Norwalk-like virus	41	California	1986	Lake ²
<i>Leptospira</i>	8	Hawaii	1987	Stream ²
<i>Shigella sonnei</i>	130	South Carolina	1987	Lake ²
<i>Shigella sonnei</i>	22	Georgia	1988	Lake ²
<i>Shigella sonnei</i>	138	Pennsylvania	1988	Lake ²
AGI	300	Vermont	1988	Lake – Recreational Area ²
AGI	36	Vermont	1988	Lake – Swimming Area ²
AGI	24	Minnesota	1988	Lake ²
AGI	22	Maine	1989	Lake ³
AGI	17	New Jersey	1989	Lake ³ (Setting: Park)
AGI	26	New Jersey	1989	Lake ³ (Setting: Swimming Area)
AGI	18	Minnesota	1990	Lake ³
<i>Shigella sonnei</i>	7	New York	1990	Lake ³
<i>Shigella sonnei</i>	9	Oregon	1990	Lake ³
AGI	60	Pennsylvania	1990	Lake ³
<i>Shigella sonnei</i>	68	North Carolina	1990	Lake ³
AGI	244	Washington	1990	Lake ³
AGI	79	Wisconsin	1990	Lake ³
<i>Leptospira</i>	6	Illinois	1991	Pond ⁴
Adenovirus	595	North Carolina	1991	Pond linked to outbreak of pharyngitis. ⁴
<i>E.coli</i>	80	Oregon	1991	Lake ⁴
<i>Shigella sonnei</i>	203	Pennsylvania	1991	Lake ⁴
<i>Shigella sonnei</i>	23	Rhode Island	1991	Lake ⁴
<i>Giardia</i>	4	Washington	1991	Lake ⁴
AGI	15	Maryland	1992	Creek ⁴
<i>Giardia</i>	43	New Jersey	1993	Lake ⁵
<i>Giardia</i>	12	Maryland	1993	Lake ⁵
<i>Shigella sonnei</i>	160	Ohio	1993	Lake ⁵
<i>Giardia</i>	6	Washington	1993	River ⁵
<i>Shigella sonnei</i>	35	Minnesota	1994	Lake ⁵
<i>Shigella sonnei</i>	242	New Jersey	1994	Lake ⁵
<i>Cryptosporidium parvum</i>	418	New Jersey	1994	Lake ⁵
<i>E. coli</i>	166	New York	1994	Lake ⁵
<i>E. coli</i>	12	Illinois	1995	Lake ⁶
AGI	12	Minnesota	1995	Lake ⁶

Table I.2 continued

Etiologic Agent	Number of cases	Location	Date	Type of Recreational Water
<i>E. coli</i>	6	Minnesota	1995	Lake ⁶
<i>E. coli</i>	2	Minnesota	1995	Lake ⁶
AGI	17	Pennsylvania	1995	Lake ⁶
<i>Shigella sonnei</i>	70	Pennsylvania	1995	Lake ⁶
<i>E. coli</i>	8	Wisconsin	1995	Lake ⁶
<i>Shigella sonnei</i>	39	Colorado	1996	Lake ⁶
<i>Shigella sonnei</i>	81	Colorado	1996	Lake ⁶
<i>Cryptosporidium parvum</i>	3	Indiana	1996	Lake ⁶
AGI	4	Indiana	1996	Lake ⁶
<i>E. coli</i>	6	Minnesota	1996	Lake ⁶
AGI	32	Oregon	1996	Lake ⁶
<i>E. coli</i>	8	Missouri	1997	Lake ⁷
<i>Schistosoma spindale</i>	2	Oregon	1997	Lake ⁷
AGI	650	Maine	1998	Lake ⁷
<i>E. coli</i>	5	Minnesota	1998	Lake ⁷
Norwalk-like virus	30	Ohio	1998	Lake ⁷
<i>Cryptosporidium parvum</i>	8	Pennsylvania	1998	Lake ⁷
AGI	41	Washington	1998	Lake ⁷
AGI	248	Washington	1998	Lake ⁷
Norwalk-like virus	18	Wisconsin	1998	Lake ⁷
<i>Leptospira</i>	375	Illinois	1998	Outbreak among triathletes exposed to a lake. ⁷
Shistosomes	2	Oregon	1999	Lake ⁸
<i>E. coli</i> O121:H19	11	Connecticut	1999	Lake ⁸
AGI	25	Illinois	1999	Lake ⁸
<i>Giardia intestinalis</i>	18	Massachusetts	1999	Swimming at a pond. ⁸
Norwalk-like virus	168	New York	1999	Lake ⁸
<i>E. coli</i> O157:H7	36	Washington	1999	Lake ⁸
<i>E. coli</i> O157:H7	5	Wisconsin	1999	Lake ⁸
<i>E. coli</i> O157:H7	5	California	1999	Lake ⁸
AGI	2	Florida	2000	Lake ⁸
AGI	4	Florida	2000	Lake - Summary states that this outbreak occurred from an outdoor spring. ⁸
AGI	32	Maine	2000	Lake/pond ⁸
<i>Cryptosporidium parvum</i>	220	Minnesota	2000	Lake ⁸
<i>Shigella sonnei</i>	15	Minnesota	2000	Lake/pond ⁸
<i>Shigella sonnei</i>	25	Minnesota	2000	Lake ⁸
<i>Leptospira</i>	21	Guam	2000	Lake ⁸
Schistosomes	6	California	2000	Pond ⁸
Schistosomes	4	California	2000	Pond ⁸
Schistosomes	2	Oregon	1999	Lake ⁸

- ¹ CDC. 1983. Epidemiologic Notes and Reports: Gastrointestinal Illness among Scuba Divers – New York City. *Morbidity & Mortality Weekly Report* 32 (44): 576-577.
- ² CDC. 1990. Waterborne-Disease Outbreaks, 1986-1988. *Morbidity & Mortality Weekly Report Surveillance Summaries* 39 (SS-1): 1-13.
- ³ CDC. 1991. Waterborne-Disease Outbreaks, 1989-1990. *Morbidity & Mortality Weekly Report Surveillance Summaries* 40 (SS-3): 1-21.
- ⁴ CDC. 1993. Surveillance for Waterborne-Disease Outbreaks - United States, 1991-1992. *Morbidity & Mortality Weekly Report Surveillance Summaries* 42 (SS-5): 1-22.
- ⁵ CDC. 1996. Surveillance for Waterborne-Disease Outbreaks - United States, 1993-1994. *Morbidity & Mortality Weekly Report Surveillance Summaries* 45 (SS-1): 1-33.
- ⁶ CDC. 1998. Surveillance for Waterborne-Disease Outbreaks - United States, 1995-1996. *Morbidity & Mortality Weekly Report Surveillance Summaries* 47 (SS-5): 1-34.
- ⁷ CDC. 2000. Surveillance for Waterborne-Disease Outbreaks - United States, 1997-1998. *Morbidity & Mortality Weekly Report Surveillance Summaries* 49 (SS-4): 1-35.
- ⁸ CDC. 2002. Surveillance for Waterborne-Disease Outbreaks - United States, 1999-2000. *Morbidity & Mortality Weekly Report Surveillance Summaries* 51 (SS-8): 1-28.

Table I.3 Selected Outbreaks from Consumption of Contaminated Fish or Shellfish

Etiologic Agent	Number of cases	Location	Date	Exposure Pathway
AGI	150	New York	1982	Fourteen separate outbreaks of gastroenteritis due to the consumption of raw clams. It appears that the outbreak originated from coastal waters in Massachusetts, Rhode Island, and New York due to harvesting beds being contaminated as a result of heavy rains during May and June. ¹
Norwalk-like virus	20	N/A	1983	Consumption of raw clams. ²
AGI	42	Maine	1984	Consumption of Seafood Newburg. ²
Hepatitis A	61	Multiple states	1988	Consumption of raw oysters harvested from water contaminated by human feces.³
<i>Vibrio cholerae</i>	26	Guam	1990	Consumption of contaminated reef fish. ³
Norwalk-like virus	73 103	Louisiana Multiple States	1993	A shellfish harvester with high levels of immunoglobulin A to Norwalk-like virus reported having been ill before the outbreak and admitted dumping sewage directly into harvest waters. ⁴
Viral gastroenteritis	N/A	Florida and Georgia	1994-1995	December 1994 to January 1995, 34 clusters of cases of viral gastroenteritis were traced to shellfish harvested to beds in Florida's Apalachicola Bay. The source of the Norwalk-like virus was attributed to sewage contamination either from land-based sources or recreational or commercial vessels, according to preliminary findings. ⁵
Viral gastroenteritis	493	Alabama, Florida, Georgia, Louisiana, and Mississippi	1996-1997	Consumption of oysters thought to have been contaminated by harvesters improperly disposing of sewage. ⁶

¹ CDC. 1982. Epidemiologic Notes and Reports: Enteric Illness Associated with Raw Clam Consumption – New York. *Morbidity & Mortality Weekly Report* 31 (33): 449-451.

² CDC. 1990. Foodborne Disease Outbreaks, 5-Year Summary, 1983-1987. *Morbidity & Mortality Weekly Report Surveillance Summaries* 39 (SS-01): 15-23.

³ CDC. 1996. Surveillance for Foodborne–Disease Outbreaks, United States, 1988-1992. *Morbidity & Mortality Weekly Report Surveillance Summaries* 45 (SS-05): 1-55.

⁴ CDC. 1993. Multistate Outbreak of Viral Gastroenteritis Related to Consumption of Oysters – Louisiana, Maryland, Mississippi, and North Carolina, 1993. *Morbidity & Mortality Weekly Report* 42 (49): 945-948.

⁵ CDC. 1995. Epidemiologic Notes and Reports: Multistate Outbreak of Viral Gastroenteritis Associated with Consumption of Oysters – Apalachicola Bay, Florida, December 1994-January 1995. *Morbidity & Mortality Weekly Report* 44 (2): 37-39.

⁶ CDC. 1997. Viral Gastroenteritis Associated with Eating Oysters – Louisiana, December 1996-January 1997. *Morbidity & Mortality Weekly Report* 46 (47): 1109-1112.

I.2 Interviewed Communities' and States' Roles and Responsibilities Matrix

As part of this report effort, EPA conducted a series of interviews with officials in state and local governments. Through the interviews, EPA sought a clearer understanding of the roles and responsibilities of these agencies in preventing, tracking, and monitoring for potential human health impacts associated with CSO and SSO discharges within their jurisdiction. The results of these interviews are summarized in the following two tables.

Table I.4 Local Agency Responsibilities Related to Human Health as Identified During Community Interviews

Community	Waterborne Illness Investigations	Recreational Water Monitoring & Posting	Wastewater Treatment	Drinking Water Monitoring	Monitoring Fish and Shellfish
Boston, MA	City Health	Metropolitan District Commission and MWRA	MWRA	MWRA	
Portland, ME	City Health Department State Health Department	State Environmental Agency	Public Works	Water District	State DEP
Cape May, NJ	County Health	County Health	County Municipal Utilities Authority	Individual Water Utilities, County Health State Environmental Agency	State Environmental Agency
New York, NY	City Health Department City Environmental Agency	State Environmental Agency	City Public Works State Environmental Agency	City Environmental Agency State Environmental Agency	State Environmental Agency
Arlington, VA	County Health Department	N/A	County Environmental Health Department	Public Works	State Environmental Agency
Erie County, PA	County Health Department	County Health Department	Public Works	Water District	N/A
Pittsburgh, PA	County Health Department	State Environmental Agency	Drinking and Wastewater Agency	Drinking and Wastewater Agency	N/A
Atlanta, GA	County Health Epidemiology & Environmental Division	County Health Environmental Division	Each municipality	Each municipality	Local Level Environmental Health
Ft. Pierce, FL	County Health Departments	County Health Departments	County Health Dept, State Environmental Agency	County Health Department	State Environmental Agency
Akron, OH	City Health Department	N/A			
Milwaukee, WI	City Health Department	City Health Department	Waste Treatment Agency		State Environmental Agency

Table I.4 continued

Community	Waterborne Illness Investigations	Recreational Water Monitoring & Posting	Wastewater Treatment	Drinking Water Monitoring	Monitoring Fish and Shellfish
Austin, TX	City/County Health Department	Watershed Protection Division			
Little Rock, AR	State Health Department	State Environmental Department	local municipalities	State Environmental Department	State Environmental Department
Tulsa, OK	County Health Department & State Health Department	State Environmental Department	City Government	City Government	State Environmental Department
Omaha, NE	County Health Department	County			
St. Louis, MO	City Health Department				
Denver, CO	City/County Environmental Agency	City/County Environmental Agency		Public Works	
Las Vegas, NV	County Health Department, Water Authority	Water Authority National Parks Service	Local Wastewater Treatment	Water Authority	County Health Department
Los Angeles, CA	State Health Department, City Health Department	City Health Department	Local sanitation districts	State Health Department, City Health Department	State Health Department
Orange County, CA	County Health Department Epidemiology	County Health Department Environmental County Sanitation District Wastewater Authority	Local water and sanitation districts	Water Authority under jurisdiction of State Department of Health	State Department of Health Services/ Biotxin Monitoring
San Diego, CA	County Environmental Health, Department of Health Epidemiology	County Environmental Health	Municipal POTWs	Local water purveyor and State Department of Health	State Department of Health and County Environmental Health
Portland, OR	State Health Department	State Health Department (ocean beaches only) State Environmental Agency	State Environmental Agency (or the Native American tribes, if treatment is associated with tribal lands)	State Health Department – monitor groundwater in general	State Environmental Agency Department of Agriculture
Seattle, WA	County Health Department				

Table I.5 State Agency Responsibilities Related to Human Health, as Identified During Interviews

State	Waterborne Illness Investigations	Recreational Water Monitoring & Posting	Wastewater Treatment	Drinking Water Monitoring	Monitoring Fish and Shellfish
New Jersey	State Department of Health	State Environmental Agency and Local Health Departments	State Environmental Agency	State Environmental Agency and Local Health Departments	State Environmental Agency
Pennsylvania	State Health	State Environmental Protection, State Department of Health	State Environmental Protection	State Environmental Protection, State Department of Health	Department of Agriculture
Florida	State Department of Health	County health officers	State Environmental Agency permits the wastewater program	State Environmental Agency oversight for drinking water suppliers	The Dept. of Agriculture, DOH issues the health advisories. State environmental agency does tissue monitoring
Massachusetts	Local Boards of Health, State Department of Health	Local Boards of Health, State Department of Health	Local Boards of Health, State Environmental Agency	State Environmental Agency	State Environmental Agency- Division of Marine Fisheries, State Department of Health
Missouri	Department of Health		State Environmental Agency	State Environmental Agency	
Wisconsin	State Department of Health and local health agencies	Local or state agency that "owns the beach"	Local Government	Local Government	State Environmental Agency
Oregon	State Health Department State Environmental Agency	State Health Department (ocean beaches only)	State Environmental Agency (or the Native American tribes, if treatment is associated with tribal lands)	State Health Department – monitor groundwater in general	State Environmental Agency Department of Agriculture

I.3 Selected Case Studies

A Case Study of the 1993 Milwaukee Cryptosporidiosis Outbreak

Background

In the spring of 1993, the City of Milwaukee, Wisconsin and surrounding areas saw a marked increase in absenteeism and reported cases of diarrhea (MacKenzie 1994). Clinical investigations found that residents were suffering from Cryptosporidiosis, a diarrheal disease caused by a microscopic parasite, *Cryptosporidium parvum*. This parasite can live in the intestines of humans and other mammals and can be passed in the feces of an infected individual (CDC 2003a). It is estimated that more than 400,000 people were infected during this outbreak; more than 600 persons had laboratory confirmed cases (MacKenzie 1994).

About Cryptosporidiosis

Cryptosporidiosis, caused by the parasite *Cryptosporidium parvum*, is a disease affecting many large mammals. Its symptoms include, diarrhea, abdominal cramps, loss of appetite, low-grade fever, nausea, and vomiting (CDC 2003a). Cryptosporidiosis is highly contagious and is passed via fecal oral contamination from one host to another. *Cryptosporidium* oocysts are very resistant to disinfection and can survive outside of a host for a long period of time. *Cryptosporidium* oocysts are found throughout the United States in soil, animal waste, and water (CDC 2003a). Once ingested by the host, the parasite attacks the small intestine and rapidly reproduces.

Incubation takes two to fourteen days from the initial infection. For individuals with healthy immune systems, the infection will last approximately two weeks; however, symptoms may cycle and the individual can appear to get better and then experience a relapse (CDC 2003a). The disease is potentially fatal for immunocompromised individuals. In those individuals the symptoms may last longer, and the disease may reappear after white blood cell numbers drop (CDC 2003b).

It is estimated that in industrialized countries, approximately 0.4% of the population pass *Cryptosporidium parvum* oocysts at any one given time, and of patients admitted to hospitals for diarrhea, 2-2.5% have Cryptosporidiosis. Further, 30-35% of the U.S. population has antibodies for *Cryptosporidium parvum*, evidence that they have been exposed to the parasite at some point (Upton 2001).

Exposure Pathway and Source of Parasite

The Milwaukee Cryptosporidiosis outbreak was caused by ingestion of contaminated water from Lake Michigan. The Milwaukee Water Works (MWW) supplies water, obtained from Lake Michigan, to the City of Milwaukee and nine surrounding municipalities via two water treatment plants, one located in the northern part of the district and the other in the south.

Beginning on approximately March 21, 1993, and continuing through April 9, the southern treatment plant reported increases in the turbidity of treated water, rising from a low of 0.25 NTU to a peak of 1.7 NTU. This finding, coupled with the fact that a majority of the laboratory and clinically confirmed cases

of Cryptosporidiosis were from households predominately supplied by the southern water treatment plant, led investigators to conclude that contaminated water from Lake Michigan was not properly filtered and was supplied to, and ingested by, residents in the southern plant treatment service area. (MacKenzie 1994) Although the environmental source of the parasite is not known, inferences include agricultural run-off, slaughterhouses, and untreated wastewater leaks (MacKenzie 1994).

Tracking, Reporting, and Response

On April 5, 1993, the Milwaukee Department of Health contacted the Wisconsin Division of Health after widespread absenteeism in key professions was reported. On April 7, 1993, two laboratories in the Milwaukee area identified *Cryptosporidium* oocysts in stool samples. On the evening of April 7, 1993, a boil water advisory was issued and the southern plant was temporarily closed on April 9, 1993 (MacKenzie 1994). Although the MWW was within required water quality limits, a streaming-current monitor, which helps determine the amount of coagulant needed for filtration, was not installed correctly. This was quickly fixed.

Impact

It is estimated that over 400,000 people were infected with Cryptosporidiosis (MacKenzie 1994). Their symptoms included: cramps, malaise, nausea, decreased appetite, weight loss, muscle pain, and rash (Frisby 1997). These symptoms resulted in decreased productivity and it was reported that the “gastrointestinal illness resulted in widespread absenteeism among hospital employees, students, and schoolteachers” (MacKenzie 1994).

Additional Comment

The Milwaukee outbreak helped identify shortcomings of the waterborne disease outbreak surveillance system that was in operation in the United States. Researchers suggested that laboratories should perform routine stool tests for *Cryptosporidium* when patients’ symptoms warranted (Mac Kenzie 1994). They also suggested that the *Cryptosporidium* tests were not sensitive enough and should be repeated in order to account for the time needed for the *Cryptosporidium* oocysts to enter the feces (Cicirello 1997). Most importantly, at the time of the Milwaukee outbreak, Cryptosporidiosis was not legally required to be reported to state health officials. As a result of this, and other outbreaks, Cryptosporidiosis is now a “reportable illness” in many jurisdictions.

A Case Study of the 1998 Brushy Creek Cryptosporidiosis Outbreak

Background

On July 13, 1998, a lightning strike during a thunderstorm incapacitated the controls at a wastewater lift station located upstream from the Brushy Creek Municipal Utility District's (MUD) five drinking water wells. This power outage caused 167,000 gallons of raw sewage to flow into Brushy Creek (TDH 1998).

Beginning on July 24, 1998, the Texas Department of Health Infectious Disease Epidemiology and Surveillance Division (IDEAS) and the Williamson County and Cities Health Districts began to receive calls from Brushy Creek residents complaining of nausea, diarrhea, and abdominal cramps. It was later determined that residents of Brushy Creek were suffering from Cryptosporidiosis. It is estimated that 60 percent of Brushy Creek's population of 10,000 were exposed to the parasite and approximately 1,440 residents contracted Cryptosporidiosis (TDH 1998).

Exposure Pathway and Source of Parasite

The Brushy Creek Cryptosporidiosis outbreak was caused by ingestion of contaminated water from the Brushy Creek MUD wells. It was reported that MUD customers whose water came from the contaminated wells were five times more likely to be ill than MUD customers whose water came from treated surface water (TDH 1998). Fecal coliform tests performed on raw water samples taken from the five wells after the sewage leak showed high levels of *E. coli* and helped to confirm that the wells had been contaminated (four of the five wells were positive)(TDH 1998).

Tracking, Reporting, and Response

In response to the massive sewage spill, the Texas Natural Resources Conservation Commission (TNRCC) instructed the Brushy Creek MUD to test its five water wells for fecal coliform (July 17). Based on results of those tests, received on July 21, the Brushy Creek MUD was ordered to take all the wells off-line and purchase water from the city of Round Rock. On July 24, 1998, the Texas Department of Health and local health districts began receiving residents' complaints of symptoms related to gastrointestinal disease, and TNRCC contacted the Texas Department of Health to request assistance with a possible waterborne disease outbreak in Williamson County (TDH 1998). In cooperation with local health departments, IDEAS distributed specimen containers to Brushy Creek residents in order to obtain stool samples. Twelve of the specimen containers were returned, all were tested and found negative for viral and bacterial pathogens, six however, were positive for *Cryptosporidium parvum* (TDH 1998).

Impact

It is estimated that 1,440 people suffered from Cryptosporidiosis during this outbreak (there were 89 laboratory confirmed cases). The infected persons complained of nausea, diarrhea, and abdominal cramps. Based on a residents survey, the mean duration of the illness was seven days (range 1- 45 days) (TDH 1998).

Additional Comments

Brushy Creek MUD wells are 100 feet deep and encased in cement. It is generally thought that these types of wells would not be influenced by surface water. This presumption is probably the reason residents of Brushy Creek were supplied water from the contaminated well for approximately eight days. This outbreak illustrates that even wells with this degree of protection can be contaminated by surface water (TDH 1998).

Forty-five additional cases of Cryptosporidiosis were reported in the Brushy Creek area between September 1 and December 31, 1998. It was not possible to determine if these cases would have occurred without the earlier water contamination because no reliable data were collected to establish a normal rate of Cryptosporidiosis in Texas.

A Case Study of the 1995 Idaho Shigellosis Outbreak

Background

In August 1995 the local health department requested that the Idaho Department of Health investigate reports of diarrheal illness among resort visitors in Island Park, Idaho. Clinical investigations found that these individuals were suffering from Shigellosis, a diarrheal disease caused by a microscopic parasite, *Shigella sonnei* (CDC 1996). This parasite can live in the intestines of humans and other mammals and can be passed in the feces of an infected organism. (CDC 2003c). Eighty-two cases were identified among visitors to the resort as well as a few cases among local residents (CDC 1996).

About Shigellosis

Shigellosis, caused by the parasite *Shigella sonnei*, is a well-recognized cause of gastrointestinal illness in humans and is the most common cause of bacillary dysentery in the United States (CDC 2003c). Symptoms include diarrhea, fever, abdominal pain, and blood or mucus in the stool. Most outbreaks of Shigellosis are attributed to person-to-person transmission, however, the disease has also been reported to spread through food, water, and swimming (CDC 2003c). Waterborne outbreaks are commonly associated with wells that have been fecally contaminated. However, because *Shigella* organisms rarely are isolated from water sources, the identification of a waterborne source usually is based on epidemiologic evidence (CDC 2003c).

Most people who are infected with *Shigella* develop diarrhea, fever, and stomach cramps starting a day or two after they are exposed. The diarrhea usually resolves in five to seven days. In some persons, especially young children and the elderly, the diarrhea can be so severe that the patient needs to be hospitalized. Some persons who are infected may have no symptoms at all, but may still pass the bacteria to others.

Approximately 14,000 laboratory confirmed cases of shigellosis and an estimated 448,240 total cases (mostly due to *Shigella sonnei*) occur in the United States each year (CDC 2003d). This disease is very common in developing countries and, depending on the strain, can be deadly. Further, *Shigella* has, in some areas, become resistant to antibiotics.

Exposure Pathway and Source of Parasite

The Island Park Shigellosis outbreak was probably caused by the ingestion of contaminated well water. Testing of wells in the neighborhood indicated that a number of the wells were contaminated with fecal coliform bacteria (CDC 1996). While cultures did not indicate the presence of *Shigella sonnei*, it is known that *Shigella* organisms are rarely successfully isolated from water sources. Identification of a waterborne source is generally based on epidemiologic evidence (CDC 1996). Plasmid profile analyses indicated that the *Shigella* organisms were of the same strain in both the infected resort visitors and the infected neighbors. This suggests that the organisms may have been transmitted from multiple wells in the same area through common groundwater (CDC 1996). The water table in the area was higher than normal due to increased rainfall levels during the spring. Inspection of a nearby sewer line found that the wastewater was not draining properly, but no specific leaks were identified when sections were excavated for inspection (CDC 1996).

Tracking, Reporting, and Response

After receiving reports of diarrheal illness among guests at the resort, the local health department recommended several prevention measures before initiating the investigation (CDC 1996). On August 17, the resort posted warning signs at water taps cautioning against drinking water; on August 19, food service was terminated; and on August 21, bottled water was placed in every room. Resort water is supplied by one well, which was dug in 1993 (CDC 1996). Samples of water obtained from the well on August 23 were positive for fecal coliform bacteria; however, cultures were negative for *Shigella*. After this testing was completed the local health department required that the resort provide bottled or boiled water to visitors and recommended that persons residing in the area have their well water tested and boil all drinking water. Since the investigation, the resort has drilled a new and deeper well (CDC 1996).

Impact

Eighty-two cases were identified among resort visitors and six cases were identified among individuals in neighboring houses. After testing well water throughout the neighborhood the local health department recommended that residents have their well water tested and a boil water advisory was put into effect. No specific source of *Shigella* organisms was ever identified.

Additional Comments

Routine water-quality testing, including testing for fecal coliform bacteria, is the most practical indicator of possible bacterial contamination of drinking water from both community and private water supplies. However, many privately owned wells are never tested for fecal coliform bacteria (CDC 1996). In addition, timely testing, reporting, and follow-up in cases of contaminated public water systems are often constrained by limited resources available to local health departments (CDC 1996).

A Case Study of the 1993 Las Vegas Cryptosporidiosis Outbreak

Background

Over a seven month period in 1993 and 1994, Clark County, Nevada, which includes Las Vegas, experienced a rise in the number of HIV-infected individuals with diarrheal disease. Clinical investigations found that these individuals were suffering from Cryptosporidiosis. There was no estimate of the number of individuals infected during the course of this outbreak (Goldstein 1996).

Exposure Pathway and Source of Parasite

The Clark County Cryptosporidiosis outbreak was most likely caused by ingestion of contaminated water from Lake Mead. The water treatment plant serving Clark County supplies water, obtained from Lake Mead, to the City of Las Vegas and the rest of the county (Goldstein 1996). It was not reported to be malfunctioning at any point during the seven month outbreak period. The maximum recorded turbidity value during the outbreak period reached 0.17 NTU, as compared with the 1.7 NTU value recorded during the 1993 Milwaukee Cryptosporidiosis outbreak (Goldstein 1996).

Due to the widespread geographic nature of the infected patients, it is assumed that the municipal drinking water supply was contaminated before reaching the treatment plant (Goldstein 1996). While the water was filtered and chlorinated at the treatment plant some *Cryptosporidium* oocysts survived the process and entered the municipal drinking water system. This is not surprising considering the resistance of *Cryptosporidium* oocysts to chlorination. Individuals then were exposed. The lack of positive test results for this parasite in the water supply, coupled with the persistence of this outbreak suggest an intermittent, low-level of contamination of the water.

Tracking, Reporting, and Response

Because water quality exceeded all standards, waterborne transmission of this parasite was not suspected and no advisory warning residents to boil their water was issued. This situation remained unchanged for approximately fourteen weeks after the possible outbreak was first noted in mid-March 1993 (Goldstein 1996).

The fact that Cryptosporidiosis is a reportable disease in Nevada combined with the awareness of physicians regarding the sensitivity of immunocompromised patients to exposure to this disease led to recognition of an outbreak that might have otherwise not been reported (Goldstein 1996). Generally, the appropriate laboratory tests that would identify Cryptosporidiosis infection are not carried out unless a physician is aware of a source of contamination in the community or if they are dealing with an individual who is particularly sensitive to this type of disease.

Impact

There is no estimate of the number of people infected during the course of this outbreak. A much higher incidence of reported infections occurred among HIV-infected individuals. The short-term mortality rate for the HIV-infected adults who had cryptosporidiosis was high. Two thirds of those who died during or shortly after the outbreak had cryptosporidiosis listed on their death certificates. These data do not differentiate dying “of” from dying “with” cryptosporidiosis. For these HIV-infected case-patients early mortality was higher, but one year mortality was not when compared with a HIV-positive, but non-*Cryptosporidium* exposed control group (Goldstein 1996).

Additional Comments

Laboratories do not routinely test for this type of infection as this diagnosis is rarely considered when not dealing with an immunosuppressed patient. Researchers suggest that the public health significance of waterborne-*Cryptosporidium* infection in the United States must be determined. To accomplish this task epidemiologists need more sensitive and rapid methods for detecting oocysts in water, workable surveillance systems able to detect cases associated with low-level transmission of *Cryptosporidium*, and epidemiologic studies specifically designed to address the risk for waterborne transmission of *Cryptosporidium* in nonoutbreak settings (Goldstein 1996).

A Case Study of the 1985 Braun Station, Texas Cryptosporidiosis Outbreak

Background

In a period between May and July 1984 two distinct gastroenteritis outbreaks were identified in the community surrounding Braun Station, Texas (D'Antonio 1985). Clinical investigations found that individuals impacted during the first outbreak were suffering from Norwalk virus and those impacted during the second outbreak were suffering from Cryptosporidiosis. This parasite can live in the intestines of humans and other mammals and can be passed in the feces of an infected organism. (CDC 2003a). *Cryptosporidium* oocysts were identified in 47 of 79 tested Braun Station patients (D'Antonio 1985). Oocysts were also identified in samples from 12 patients suffering from gastroenteritis, but who did not reside in Braun Station.

Exposure Pathway and Source of Parasite

No geographical clustering or age-related patterns emerged upon examination of the July Cryptosporidiosis outbreak in Braun Station. However, consumption of tap water was greater among those afflicted and individuals who were not in the area during the month of July were generally not infected (D'Antonio 1985). Public drinking water is drawn from an artesian well that is not filtered, but is chlorinated shortly before distribution. The outbreak was investigated as it occurred. Well water is generally not tested in this region of Texas, but community complaints convinced authorities to begin testing in mid-June. Chlorinated water samples were found to be coliform-negative. However, untreated well water samples tested had fecal coliform counts as high as 2600/100 mL (D'Antonio 1985). A boil water advisory was put into effect. Subsequent dye tests indicated that the community's wastewater system was leaking into the well water. Attempts to identify the exact site of contamination were not successful. The pattern of repeated outbreak but differing major causative agent suggested that contamination of the water supply was intermittent (D'Antonio 1985). The community was provided with an alternate water supply.

Tracking, Reporting, and Response

A cluster of patients suffering from gastroenteritis in Braun Station led to the recognition of both outbreaks. Community-requested water testing and subsequent dye tests identified wastewater contamination of the community's well water. A boil water advisory was issued after evidence of contaminated water was gathered. When the source of the wastewater could not be identified and stopped, an alternative water source was provided to the community. The differing types of causative agents at the root of each outbreak suggested intermittent water supply contamination.

Impact

Symptoms associated with Cryptosporidiosis infection were experienced by an estimated 2,006 patients in Braun Station. Once the source of infection was identified, proper steps were taken to ensure that the community was supplied with a healthy water supply.

References for Case Studies

- Bitton, G. 1980. *Introduction to Environmental Virology*. New York, NY: John Wiley & Sons.
- Centers for Disease Control and Prevention (CDC). 1996. *Shigella sonnei* Outbreak Associated with Contaminated Drinking Water- Island Park, Idaho, August 1995. *Morbidity and Mortality Weekly Report* 45(11): 229-234.
- CDC. 2003a. "Parasitic Disease Information Fact Sheet: Cryptosporidiosis." Retrieved May 12, 2003b. http://www.cdc.gov/ncidod/dod/parasites/cryptosporidiosis/factsheet_cryptosporidiosis.htm.
- CDC. 2003b. "Preventing Cryptosporidiosis: A Guide for People With Compromised Immune Systems." Retrieved May 12, 2003c. http://www.cdc.gov/ncidod/dpd/parasites/cryptosporidiosis/factsht_crypto_prevent_ci.htm.
- CDC. 2003c. "Disease Information: Shigellosis". Retrieved September 2003. http://www.cdc.gov/ncidod/dbmd/diseaseinfo/shigellosis_g.htm.
- Cicirello H.G., et. al. 1997. Cryptosporidiosis in Children During a Massive Waterborne Outbreak in Milwaukee, Wisconsin: Clinical, Laboratory, and Epidemiologic Findings. *Epidemiol Infect* 119(1):53-60.
- D'Antonio, R.G., et al. 1985. A waterborne outbreak of cryptosporidiosis at Brushy Creek. *Epidemiology in Texas, 1999 Annual Report*. *Annals of Internal Medicine* 103(6): 886-888.
- Frisby, H.R. 1997. Clinical and Epidemiologic Features of a Massive Waterborne... *Journal of Acquired Immune Deficiency Syndromes and Human Retrovirus* 16 (4-5): 223-422.
- Goldstein, S.T., et al. 1996. Cryptosporidiosis: An Outbreak Associated with Drinking Water Despite State-of-the-Art Water Treatment. *Annals of Internal Medicine* 124(5):459-968.
- MacKenzie W.R., et. al. 1994. A Massive outbreak in Milwaukee of *Cryptosporidium* infection transmitted through the public water supply. *N English journal of Medicine*. 331:161-7.
- Texas Department of Health (TDH). 1998. Cryptosporidiosis at Brushy Creek. *Epidemiology in Texas, 1999 Annual Report*. <http://www.tdh.state.tx.us/epidemiology/98annual/reports/crypto.pdf>.
- Upton, S.J. 2001. *Cryptosporidium: they probably taste like chicken*. Presented at the Cryptosporidium from Molecules to Disease Conference, Fremantle, Western Australia, October 7-12, 2001. (Cited in Text Box 1: About Cryptosporidiosis)

I.4 Tables showing various concentrations of pathogenic bacteric, enteric viruses, and parasitic protozoa in sewage.

Table I.6 Concentrations of Common Pathogenic Bacteria in Sewage

Bacteria	Concentration in Sewage (per 100mL)	Reference
<i>Campylobacter</i>	3,700	Holler 1988
	10,000-100,000	WHO 2003
Pathogenic <i>E.coli</i>	1,321,594 (30,000-6,200,000)	Payment 2001
	1,000,000-10,000,000	WHO 2003
	1,190,000	Gore et al. 1999
	2,500,000	
	3,180,000	
	4,120,000	
	2,880,000	
	1,600,000	
	2,170,000	
<i>Salmonella</i>	2.3-8,000	NAS 1993
	240-1,200	Koivunen 2003
	93-1,100	
	1,100-11,000	
	150-1,100	
	100-10,000	
	400-8,000	NRC 1998
	8,000	EPA 1992
	528	NRC 1996
	400-1,200	Bitton 1980
	500-8,000	Pettygrove and Asano 1985
	418	Yates 1994
	0.2-8,000	Payment and Franco 1993
	13	WHO 2003
	62	
>190		
45		
<20		
170		
<40	Gore et al. 1999	
<i>S. typhi</i>	--	--
<i>Shigella</i>	1-1,000	NAS 1993
	1-1,000	EPA 1992
	1,000	NRC 1996
	1-1000	NRC 1998
	0.1-1,000	WHO 2003
<i>Vibrio cholera</i>	--	--
<i>Vibrio non-cholera</i>	10-10,000	NAS 1993
<i>Yersinia</i>	--	--

Table I.7 Concentrations of Enteric Viruses Present in Sewage

Virus Group	Concentration in Sewage (per 100mL)	Reference
Adenovirus	10-10,000	NAS 1993
Astrovirus	--	--
Noravirus (includes Norwalk-like viruses)	--	--
Echovirus	--	--
Enterovirus (includes polio, encephalitis, conjunctivitis, and coxsackie viruses)	18.2-9,200	NAS 1993
	>0.720	Rose 2001a
	>11	
	23	
	4.5	
	96.2 (0.4-1,251)	Payment et al. 2001
	1,000-10,000	NRC 1998
	1.085	
	1	
	7	
	5	
	40	
	2	
	1	
	1.1	Rose 2001 (WER article)
	100-50000	EPA 1992
7 (0.75-80)	Hejkal 1984	
1.98	Smith and Gerba 1982	
0.05		
14.8		
3.95		
6.91		
3.95		
50,000	NRC 1996	
100-49,200	Pettygrove and Asano 1985	
10,000-100,000	Yates 1994	
0.284	Payment and Franco 1993	
0.42	Rose 1996	
10,000	Wyn-Jones and Sellwood 2001	

Table I.7 continued

Virus Group	Concentration in Sewage (per 100mL)	Reference
Reovirus	0.1-124.7	NAS 1993
Rotavirus	40.1	NAS 1993
	0.98 (0.1-32.1)	Hejkal et al. 1984
	9.6	Smith and Gerba 1982
	9.6	
	6.7	
	17.4	
	8	
	1.5	
400-85,000	WHO 2003	

Table I.8 Concentrations of Common Parasitic Protozoa Present in Sewage

Parasitic Protozoa	Concentration in Sewage (per L)	Reference
<i>Cryptosporidium</i>	10-1000	NAS 1993
	47.7	Chauret 1999
	6 (1-560)	Payment 2001
	<40-625	Mahin and Pancorbo 1999
	226.0	
	60 (3-400)	
	20 (0-3,000)	
	20	
	17	Rose 2001a
	<4.348	
	8.16	
	9.52	
	14.84	
	15	NRC 1998
	0.3	
	2	
	1	
	15	
	15	Rose 2001b
	7.42	Payment and Franco 1993
40	LA County SD 2003	
280		
160		
80		
120		
3.7	Rose 1996	
69.1	Gennaccaro et al. 2003	
1-390	WHO 2003	
<2-24	McCuin and Clancy 2004	
0		
0		
<2		
2		
<2-8		
<2-8		
<2-24		
4.1-13,700		
28-52		NAS 1993
0-100	EPA 1992	
4.0	Bitton 1980	
4	WHO 2003	

Table I.8 continued

Parasitic Protozoa	Concentration in Sewage (per L)	Reference
<i>Giardia</i>	530-100,000	NAS 1993
	82.5	Chauret 1999
	1,165 (100-9,200)	Payment 2001
	390	Mahin and Pancorbo 1999
	315	
	10-13,600	
	642-3,375	
	354 (90-2,830)	
	290 (40-1,140)	
	200	
	480	
	200	
	220	
	42.86	
	490	NRC 1998
	69	
	39	
	325	
	2	
	69	
490	Rose 2001b	
13.76	Payment and Franco 1993	
29,000	LA County SD 2003	
19,000		
16,000		
27,000		
32,000		
4,760		
5,080		
15,560		
9,760		
19,280		
500-100,000	EPA 1992	
100,000	NRC 1996	
9,000-200,000	Yates 1994	
39	Rose 1996	
125-200,000	WHO 2003	

References for Tables I.6 - I.8

Bitton, G. 1980. *Introduction to Environmental Virology*. New York, NY: John Wiley & Sons.

Chauret, C., et al. 1999. Fate of *Cryptosporidium* oocysts, *Giardia* cysts, and microbial indicators during wastewater treatment and anaerobic sludge digestion. *Canadian Journal of Microbiology* 45:257-151.

Environmental Protection Agency (EPA). 1992. *Manual: Guidelines for Water Reuse*. EPA 625/R-92/004.

Gennaccaro, A.L., et al. 2003. Infectious *Cryptosporidium parvum* oocysts in final reclaimed effluent. *Applied and Environmental Microbiology* 69(8): 4983-4984.

Gore, R., et al. 1999. *Report No. 99-17: Bacteria in raw sewage and viable helminth ova in raw sewage and primary sludge at the water reclamation plants of the Metropolitan Water Reclamation District of Greater Chicago*. Metropolitan Water Reclamation District of Greater Chicago Research and Development Department. Chicago, IL.

Hejkal, T.W., et al. 1984. Seasonal occurrence of rotavirus in sewage. *Applied and Environmental Microbiology* 47(3): 588-590.

Holler, C. 1988. Quantitative and qualitative investigations of *Campylobacter* in a sewage treatment plant. *Zentralblatt für Bakteriologie, Mikrobiologie und Hygiene. Serie B* 185: 326-339.

Koivunen, J., et al. 2003. Elimination of enteric bacteria in biological-chemical wastewater treatment and tertiary filtration units. *Water Research* 27: 690-698.

Los Angeles County Sanitation Districts. 2003. Memo containing a summary of various *Giardia* cyst and *Cryptosporidium* oocyst data sets compiled by the San Jose Creek Water Quality Laboratory over the previous nine years. July 21, 2003.

Mahin, T., and Pancorbo, O. 1999. Waterborne pathogens: more effective analytical and treatment methods are needed for pathogens in wastewater and stormwater. *Water Environment and Technology* 11(4): 51-55.

McCuin, R.M. and Clancy, J.L. 2004. *Cryptosporidium* Occurrence, Removal and Inactivation Methods for Wastewaters. Final Report: Water Environment Research Foundation, Project 98-HHE-1, Alexandria, VA. In press.

National Academy of Sciences (NAS). 1993. *Managing Wastewater in Coastal Urban Areas*. Washington, D.C: The National Academies Press.

National Research Council (NRC), Committee on the Use of Treated Municipal Wastewater Effluents and Sludge in the Production of Crops for Human Consumption. 1996. *Use of Reclaimed Water and Sludge in Food Crop Production*. Washington, D.C: The National Academies Press.

National Research Council (NRC), Committee to Evaluate the Viability of Augmenting Potable Water Supplies with Reclaimed Water. 1998. *Issues in Potable Reuse: The Viability of Augmenting Drinking Water Supplies with Reclaimed Water*. Washington, D.C: The National Academies Press.

Payment, P., and Franco, E. 1993. *Clostridium perfringens* and somatic coliphages as indicators of the efficiency of drinking water treatment for viruses and protozoan cysts. *Applied and Environmental Microbiology* 59(8): 2418-2424.

Payment, P., et al. 2001. Removal of indicator bacteria, human enteric viruses, *Giardia* cysts, and *Cryptosporidium* oocysts at a large wastewater primary treatment facility. *Canadian Journal of Microbiology* 47: 188-193.

Pettygrove, G.S., and Asano, T. 1985. *Irrigation with Reclaimed Municipal Wastewater—A Guidance Manual*. Prepared by the Department of Land, Air, and Water Resources, University of California, Davis for the California State Water Resources Control Board. Ann Arbor: Lewis Publishers, Inc. (Reprint).

Rose, J.B., et al. 1996. Removal of pathogenic and indicator microorganisms by a full-scale water reclamation facility. *Water Research* 30(11): 2785-2797.

Rose, J.B., et al. 2001a. *Reduction of pathogens, indicator bacteria, and alternative indicators by wastewater treatment and reclamation processes*. Water Environment Research Federation. Project Number 00-PUM-2T.

Rose, J.B., et al. 2001b. Reduction of enteric microorganisms at the Upper Occoquan Sewage Authority Water Reclamation Plant. *Water Environment Research* 73(6): 711-720.

Smith, E.M., and Gerba, C.P. 1982. Development of a method for detection of human rotavirus in water and sewage. *Applied and Environmental Microbiology* 43(6): 1440-1450.

World Health Organization (WHO). 2003. *Guidelines for Safe Recreational Water Environments, Volume I: Coastal and Fresh Waters*. Geneva: World Health Organization.

Wyn-Jones, A.P., and Sellwood, J. 2001. Enteric viruses in the aquatic environment. *Journal of Applied Microbiology* 91: 945-962.

Yates, M.V. 1994. *Monitoring concerns and procedures for human health effects*. In: *Wastewater Reuse for Golf Course Irrigation*. Ann Arbor: Lewis Publishers.

Appendix J

Estimated Annual Illness Burden
Resulting from Exposure to CSOs and
SSOs at BEACH Survey Beaches

This appendix provides a detailed description of the data and methodology used by EPA to estimate the annual illness burden associated with exposure to CSO and SSO discharges in recreational waters at state-recognized beaches. The analysis does not capture all of the likely annual illnesses attributable to CSOs and SSOs at beaches. EPA believes that CSO and SSO contamination at swimming areas other than those included in this analysis causes additional illnesses in exposed swimmers. A lack of information on these swimming areas, including water quality reporting data, precludes developing a more complete estimate of annual human illness frequency from beach exposure to CSO or SSO contaminants at this time. Moreover, this analysis accounts only for gastrointestinal illnesses.

J.1 National Health Protection Survey of Beaches

EPA's BEACH Survey served as the primary data source for estimating exposure to CSO and SSO discharges to recreational waters, as noted in Section 6.2.1.

BEACH Survey data include beach-specific information on advisories and closings for 3,067 beaches from 274 federal, state, and local agencies; not all beaches provided data for the four-year period. Beaches included in the survey are located in 34 states and the U.S. territories of Guam, Puerto Rico, and the U.S. Virgin Islands. These beaches are primarily marine water beaches, but some freshwater beaches are included. Table J.1 shows the number of beaches covered in the BEACH Survey for each state and the number of beaches with and without pre-emptive actions or monitoring programs.

As shown in Table J.2, California accounts for a significant portion of the total number state-recognized beaches, closure events, and closure events attributed to CSO and SSO discharges. As a result, California may exert a disproportionate influence on illness estimates. There are several possible explanations for this, including that California has a longer swimming and monitoring season and has more rigorous monitoring programs than many other beaches in the nation, resulting in the discovery of more events than at beaches with less frequent monitoring and with an abbreviated swimming season. However, EPA lacks the data to make these comparisons at the time.

Although the BEACH Survey was initiated in 1998 (for the 1997 swim season), only data for the 1999, 2000, 2001, and 2002 swimming seasons were used. Data from the 1997 swimming season were excluded from this analysis because the initial BEACH Survey did not request information from respondents on the source, reason, or cause of advisories or closings. Further, information from the 1998 swimming season was not used due to an error in the data recording procedures.

The BEACH Surveys have been modified over time, including changes to the wording of some questions between 1999 and 2002. Furthermore, the rate of participation by beach authorities has changed somewhat with each BEACH Survey. Nonetheless, EPA believes these differences do not preclude using data from the four most recent surveys.

EPA recognizes the limitations of the BEACH Survey. Specifically, although the data provided by the respondents are reviewed by EPA for potential gross errors, the quality and accuracy of the information may vary significantly with each respondent. In addition, because the BEACH Survey data used in the analysis cover only four years significant climatological events such as La Nina, which caused a severe drought in southern California during 1999, could have a disproportionate affect on the number of CSOs and SSOs reported in the database. Despite these shortcomings, EPA believes that the BEACH Survey is the most accurate and comprehensive source of information on beach contamination and beach authority responses to contamination events. For the purposes

Table J.1. Number of BEACH Survey Beaches and Type of Program by State

State	Number of beaches in BEACH survey ¹	Beaches with pre-emptive actions and/or monitoring	Beaches with no pre-emptive actions or monitoring
Alabama	38	22	16
California	1,078	803	275
Delaware	70	70	0
Florida	962	858	104
Georgia	16	16	0
Guam	160	160	0
Hawaii	288	288	0
Illinois	153	153	0
Indiana	185	185	0
Iowa	102	102	0
Louisiana	16	16	0
Maine	25	18	7
Maryland	200	199	1
Massachusetts	783	748	35
Michigan	812	771	41
Minnesota	74	61	13
Mississippi	9	9	0
New Hampshire	689	689	0
New Jersey	906	906	0
New York	893	837	56
North Carolina	80	80	0
Northern Mariana Islands	3	3	0
Ohio	252	252	0
Pennsylvania	60	60	0
Puerto Rico	47	47	0
Rhode Island	480	480	0
South Carolina	105	105	0
Texas	65	44	21
Vermont	133	132	1
Virgin Islands	145	145	0
Virginia	56	35	21
Washington	202	184	18
Wisconsin	196	138	58
Total	9,671	9,002	669

¹ The number of total beaches include beaches that reported in any of the four years of the BEACH survey used in this analysis: 1999, 2000, 2001, 2002; thus, a beach that reported in all four years would be counted four times.

Table J.2. Comparison of California reporting to all other states in the Beach Survey

	CA	All other states	Total	Percent
1999 Beach Survey				
Number of Beaches	256	1,795	2,051	12.5%
Number of all events	1,277	665	1,942	65.8%
Number of SSO/CSO events	22	102	124	17.7%
2000 Beach Survey				
Number of Beaches	281	2,073	2,354	11.9%
Number of all events	1,545	1,214	2,759	56.0%
Number of SSO/CSO events	61	148	209	29.2%
2001 Beach Survey				
Number of Beaches	272	2,171	2,443	11.1%
Number of all events	1,495	2,184	3,679	40.6%
Number of SSO/CSO events	268	59	327	82.0%
2002 Beach Survey				
Number of Beaches	269	2,554	2,823	9.5%
Number of all events	1,057	2,157	3,214	32.9%
Number of SSO/CSO events	76	196	272	27.9%

of this analysis, EPA contacted a limited number of BEACH Survey respondents to collect additional data on monitoring practices and levels of contamination resulting from SSO events. Other data were obtained from publicly available sources including beach authority websites, where available.

J.2 Methodology for Counting a CSO or SSO Event

In the BEACH Survey, beach authorities were asked to select the sources of pollution that caused any closures or advisories. Respondents could choose the following:

- SSO
- CSO
- CSO/SSO
- POTW
- Septic systems
- Sewer line/blockage/break
- Boat discharge
- Storm water runoff
- Wildlife
- Unknown
- Other (please specify)

For advisories and closings where “SSO” or “sewer line/blockage/break” were identified, the event was classified as an SSO.

J.3 Categorizing BEACH Survey Beaches

Based on the management practices used to address contamination events, each beach authority and its

corresponding beach(es) were assigned to one of the following categories:

- (1) Beaches where the sewer authority reports CSO and SSO events to the beach authority.
- (2A) Beaches that preemptively initiate advisories or closures due to wet weather events.
- (2B) Beaches where advisories or closure decisions are based on monitoring data or preemptive actions due to wet weather events.
- (3) Beaches where advisory or closure decisions are made based on beach monitoring alone.
- (4) Beaches that have reported advisories and closures, but do not have programs described in Categories 1, 2, and 3.

J.4 Calculation of Swimmer Days

The number of swimmers per typical day at beaches where either a closing or advisory action had been implemented (due to CSOs or SSOs) was estimated by using beach attendance data included in the BEACH Survey. The BEACH Survey contained the following responses to the question on attendance per day:

- Less than 100
- 100 - 499
- 500 - 999
- 1,000 - 9,999
- More than 10,000
- Don't know

Respondents provided answers for weekdays, weekend days and holidays, during the summer season, and during other seasons. Respondents also estimated the length of their swimming season and the percentage of beach visitors that go into the water.

To calculate the number of swimmers per day on weekdays, on weekend days, for the summer season, and for the "other season" category, a midpoint value was selected to represent each numeric response range. For example, 50 was assigned for the "less than 100" response, and 5,500 for the "1,000 - 9,999" response. For a beach where the response was "more than 10,000," EPA assumed an average summer weekday attendance value of 10,000. For a beach where the response was "don't know", the overall average for beaches who supplied data was used.

The difference between the weekday and weekend values was estimated separately for each year of data. For example, the BEACH Survey data for the 2002 BEACH Survey indicated that during the summer, the average weekend attendance levels were on average 62 percent greater than during the weekdays. For the other seasons, weekend attendance was on average 31 percent greater than the weekday.

A daily summer average was estimated by multiplying the summer weekday value by five, multiplying the summer weekend value by two and dividing the sum by seven. This procedure was repeated to estimate the daily average for "other seasons." EPA next calculated a daily average for the year, which consisted of summer and other season daily averages. EPA estimated the proportion of the values for "summer weekday," "summer weekend," "other weekday," and "other weekend" based on the length of the season of the beach. If a beach authority reported that the swim season was six months long, the summer values were counted for six months of the year and the other values were counted for six months of the year. Similarly, if a beach authority noted that the swim season was only three months long, summer values were counted for three months of the year, and other values were counted for nine months of the year.

The percentage of swimmers that enter the water was calculated for each beach, because it was assumed that only the people who actually go in the water are at risk from CSO- and SSO-related contamination. The percentage of swimmers was estimated for each beach based on the beach authority's response to the question: "What percentage of people who use this beach go into the water?" If a beach did not respond to this question the overall

average (calculated for all beaches that answered in that survey year) was substituted. Some beaches responded with a range. In these cases, the midpoint of the range was used. In other cases, beaches responded with either less than or greater than a number. In these cases, the midpoint between the number provided and 0 or 100 was used (e.g., if a beach responded greater than 95 percent, then the value used was 97.5). The percent of swimmers was applied to the attendance for each beach to yield the number of swimmers at each beach.

J.5 Extrapolation Method

This section describes the methods used to extrapolate the exposure estimates for swimmers at BEACH Survey beaches to other state-recognized beaches that did not participate in the BEACH Survey.

From responses to BEACH Survey questions about visitation and the fraction of visitors who swim, EPA estimated that 315 million swimmer days per year occur at the BEACH Survey beaches. The BEACH Survey, however, does not cover all swimming at state-recognized beaches. For example, approximately 13 percent of the beach authorities to whom the survey was mailed did not respond.

To estimate 1) the number of swimmers at state-recognized beaches not accounted for in the BEACH Survey and 2) the number of swimmers not accounted for at beaches where authorities received a survey and did not respond, EPA compared selected BEACH Survey attendance data with corresponding state attendance data estimates reported on the U.S. Life Savers Association and state web sites. A comparison of the Beach Survey data with the other state attendance data is shown in Table J.3. EPA used an adjustment factor of 1.362 to extrapolate the

Table J.3 Attendance Adjustment Calculations

State	Estimated Attendance in BEACH Survey	Total Attendance Including Alternate Sources
California	143,283,136	171,146,608
Delaware	2,479,627	6,000,000
Hawaii	9,462,739	17,285,810
Illinois	5,399,233	24,885,197
Maryland	3,353,142	4,000,000
Total	163,977,877	223,317,615
Adjustment factor		1.362

number of swimmer days from the BEACH Survey beaches to all state-recognized beaches in the United States.

EPA applied an approach based on attendance to estimate the fraction of all beach swimmer days represented by BEACH Survey respondents. The Agency did not have sufficient data to support the assumption that visitation and swimmer days are proportional to mileage of beaches. EPA believes that heavily-used beaches are more likely to be surveyed by and respond to the BEACH Survey than are lightly-attended beaches. EPA also assumes that BEACH Survey beaches likely account for a substantially larger fraction of total beach visitation than the fraction of total beach mileage accounted for by these beaches. Using the attendance-based approach, EPA estimated that BEACH Survey beaches account for 73 percent of total national visitation and swimmer days at all state-recognized beaches.

This approach resulted in the following estimated distribution of the estimated 429 million days per year of outdoor non-pool swimming:

- 315 million swimmer days at BEACH Survey beaches
- 114 million swimmer days at other formal beaches that either were not sent or did not respond to the BEACH Survey

These swimmer days are distributed among categories as shown in Table J.4.

Table J.4 Number of Swimmer Days Per Year, by Category

Number of Swimmers/Year	Category 1	Category 2A	Category 2B	Category 3	Category 4	Total
BEACH Survey beaches	135,049,677	3,674,342	41,754,509	114,619,121	19,763,032	314,860,682
Beaches not in Survey	48,871,303	1,319,658	15,109,975	41,477,965	7,151,776	113,940,677
Total	48,871,303	1,319,658	15,109,975	156,097,086	26,914,808	428,801,359

J.6 Exposure/Noncompliance Rates

It is important to note that each jurisdiction has its own definition of an advisory. EPA defines an advisory as “a recommendation to the public to avoid swimming in water that has exceeded applicable water quality standards to reduce the potential of contracting a swimming related illness.” Although each jurisdiction’s definition may vary, most authorities use an advisory to recommend that visitors not swim in the water. Closures, on the other hand, usually require that visitors do not enter the water or beach area. The degree to which a closure is enforced, however, can vary widely.

Different jurisdictions also have different policies regarding when they issue a closure or an advisory. South Carolina, for example, issues advisories only and does not issue closures. California generally issues an advisory on a preemptive basis when there is heavy rain; posts a beach warning when monitoring indicates a standard is exceeded, but there is no known source of human sewage; and closes a beach when there is a CSO, SSO, or repeated exceedances of standards. The State of New Jersey issues closures only. And, in many states, individual communities have policies on advisories and closures that can differ from the state’s policy regarding state-owned beaches.

For this analysis, EPA found it was not feasible to standardize the BEACH Survey data and adjust for differences in how jurisdictions define and use advisories and closures. Instead, EPA aggregated advisories and closures and refers to them collectively as “actions.” Among the “actions” taken by beach authorities in response to CSO or SSO events, 63 percent were denoted as closures and 37 percent were denoted as advisories.

Effectiveness of actions was estimated by requesting information on the actual effectiveness of beach closures and advisories in preventing swimming from several local lifeguard offices. There was consensus that closures are typically well enforced and effective in preventing swimming. Based on this input, EPA assumes that 95 percent of potential swimmers at a closed beach would comply. The effectiveness of advisories estimate was based on information in the report, *Coastal Beach Water Quality and Public Health: Preliminary Steps Toward Improving Public Notification in Wisconsin Under the Federal Beach Act* (Vail, 2002). It reports results from a social survey conducted at Wisconsin’s public beaches in 2002, in which survey respondents were shown a sign stating “Alert, Elevated Bacteria Levels, Swim at your own Risk.” The survey respondents were asked, “If you saw this sign posted at this beach, would you swim here?” and could answer either “yes,” “no,” or “don’t know.” Results were obtained for several different counties in Wisconsin. For this analysis, EPA weighted the responses by population and used the response rate for “no” as the lower bound of compliance; the upper bound was calculated by adding percent “no” and “don’t know”. For example, in Door County, 6 percent of the respondents answered “yes,” 9 percent

Table J.5 Calculations for Advisory Compliance Rates

County	Lower Bound	Upper Bound	Population*	Percent of Population
Kenosha	41	95.5	156,209	9.22
Racine			192,284	11.36
Milwaukee			933,221	55.11
Ozaukee	27	73	84,772	5.01
Sheboygan			113,376	6.70
Manitowac			82,065	4.85
Kewaunee			20,455	1.21
Door County	9	94	28,402	1.68
Iron	9	72	6,727	0.40
Ashland			16,561	0.98
Bayfield			15,114	0.89
Douglas			44,093	2.60
Weighted Average	36.42	90.33	1,693,369	

* Population estimates obtained from U.S. Census 2003.

answered “no,” and 85 percent responded “don’t know.” The upper bound of compliance was calculated by adding the response rate for no (9 percent) and don’t know (85 percent) to yield 94 percent, and the lower bound of compliance only accounts for the “no” responses (9 percent). Survey results and populations from 12 counties are shown in Table J.5.

In estimating the overall effectiveness of actions, EPA developed a weighted average of the effectiveness of closures (95 percent effective) and advisories (36 to 90 percent effective), weighted by the proportion of CSO- or SSO-caused actions in the baseline that are closures (63 percent) and advisories (37 percent). This results in an estimate that 73 to 93 percent of potential swimmers, on average, will not swim at a beach when the beach is under a CSO- or SSO-related action. Conversely, 7 to 27 percent would swim at a beach when a beach is under a CSO- or SSO-related action.

J.7 Monitoring Data Analysis

Figure J.1 presents a timeline that shows the relevant events in detecting and responding to beach contamination from a CSO or SSO discharge and the duration between these events. The timeline is portrayed for instances in which contamination from a CSO or SSO is detected through monitoring at the beach.

The monitoring data from the beach authorities were analyzed to determine approximately when the contamination was discovered, when the existence of the contamination was confirmed by analysis of an additional sample by a beach authority, when the beach authority issued the action, and the period during which the action remained in effect. The results of this analysis are summarized, by category, on the next page and are shown in Table J.6.

Category 1 Beaches with preemptive programs close beaches upon notification of CSO or SSO discharges. It is assumed that the beach is closed prior to contamination and lasts until contamination ends. To calculate exposure duration, duration data from the 2001 and 2002 BEACH Survey (end date subtracted

Figure J.1 Timeline for Response Activities to CSO and SSO Discharges

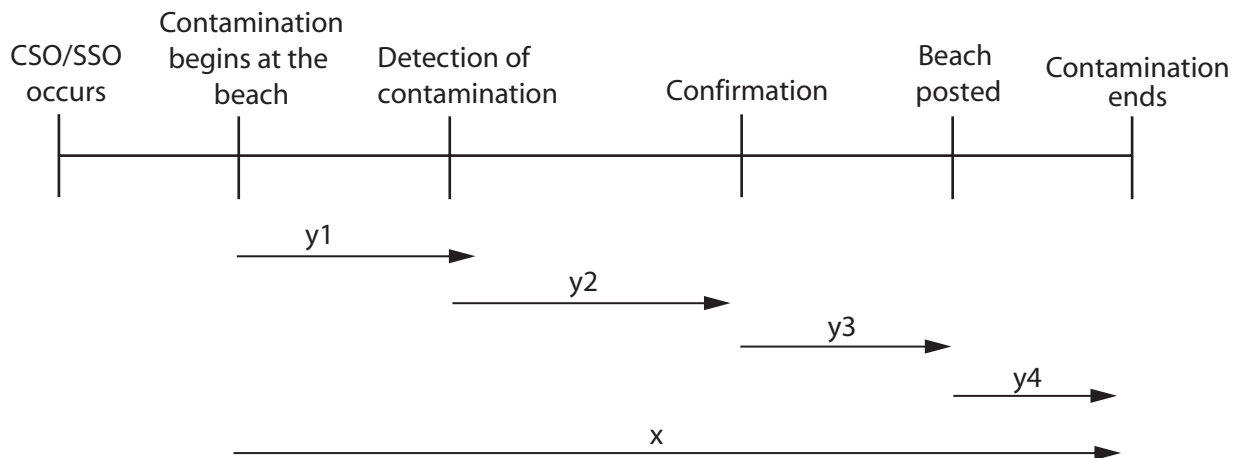

- x = The length of time that contamination from the CSO or SSO exists at the beach.
- y1 = The period between the onset of contamination at the beach and when it was detected.
- y2 = The period between the detection of contamination and its confirmation by the beach authority.
- y3 = The period between confirmation and action (e.g., beach posting, closure, public notification).
- y4 = The period during which the action remains in effect.

from start date) were averaged for all Category 1 beaches. The average length of exposure duration was 5.1 days.

Category 2A The preemptive programs for precipitation events (where beaches automatically close or post an advisory due to a precipitation event) prevent the full duration exposure to CSOs and wet weather SSOs, but not dry weather SSOs. Because there is no monitoring or other means to detect dry weather SSOs, it was assumed that exposure to these SSOs occurs. The estimated exposure duration for these events is 2.1 days.

Category 2B Similar to Category 2A, preemptive programs for precipitation events eliminate exposure due to wet weather CSOs and SSOs. Some percent of dry weather SSOs would be detected and actions would be taken; however, some exposure occurs due to the delay from monitoring. For the purposes of this analysis, EPA assumed that the percentage of SSO events that were dry weather and that were wet weather were the same as the percentage of such events reported in the BEACH Survey. That is 34 percent of the events in Category 2B occurred during dry weather and 66 percent were wet weather related. Exposure to contamination due to dry weather events was estimated to last 8.7 days, and exposure during wet weather contamination events was estimated to last 4.5 days.

Category 3 CSOs and SSOs at these beaches are acted upon once monitoring results confirm contamination, and therefore exposure is avoided only during the period of closure. Exposure during the actions is 4.5 days and exposure during the lag period is 4.2 days, for a total exposure period of 8.7 days.

Table J.6. Duration Calculations by Category

Time Periods	Category					Explanation
	1	2A	2B	3	4	
Y1	NA	NA	2.56	2.56	NA	For beaches for which there were monitoring data (categories 2b and 3), the value was calculated by subtracting the date of the first contaminated sample from the date of the last clean sample and dividing by 2.
Y2	NA	NA	1.00	1.00	NA	For beaches for which there were monitoring data (categories 2b and 3), the value was calculated by subtracting the date of confirmation from the date of the first contaminated sample.
Y3	NA	NA	0.68	0.68	NA	For beaches for which there were monitoring data (categories 2b and 3), the value was calculated by subtracting the start date of the action from the date of confirmation.
Y4	5.13	2.1	4.45	4.45	10.07	For beaches for which there were monitoring data (categories 2b and 3), the value was calculated by subtracting midpoint between the end date as reported in the beach report and the last sample showing contamination from the start date of the action. For beaches for which there was no monitoring data (Categories 1, 2a, and 4), the end date was subtracted from the start date reported in the beach survey.
TOTAL	5.15	2.1	8.69	8.69	10.07	Calculated by adding Y1-Y4

Category 4 Although there were no reported mechanisms in place to detect CSOs and SSOs for these beaches in the BEACH Survey, some of these beaches reported advisories and closings caused by CSOs or SSOs. EPA calculated the duration reported from these beaches to be 10 days.

EPA combined information on the number of baseline CSO- and SSO-related contamination events documented in the BEACH Survey, the duration of events and days of exposure, and the number of swimmer-days, to estimate the number of swimmer-days of exposure to CSOs and SSOs that would occur at the beaches included in this analysis. The results of this analysis are summarized in Table J.7.

Table J.7 Calculations for Exposed Swimmer-Days

Step	Category						Total
	1	2A	2B	3	4		
1999-2002 Beach Survey Data	Number of beaches	3,907	91	985	4,020	668	9,671
	Average number of beaches per year	977	23	246	1,005	167	2,418
	Number of SSO and CSO events acted upon in survey	118	5	14	77	20	234
	Number of events per year, per beach	0.121	0.209	0.055	0.076	0.117	--
	Number of swimmer days/year for beaches	183,920,980	5,004,000	56,864,485	156,097,056	26,914,808	428,801,329
Exposure during noncompliance	Days of exposure during noncompliance (per event)	5.13	2.10	4.45	4.45	10.07	--
	Number of such events per year, per beach	0.121	0.209	0.055	0.076	0.117	--
	Number of days of exposure during non-compliance	0.622	0.438	0.244	0.339	1.175	--
	Percent of year	0.17%	0.12%	0.07%	0.09%	0.32%	--
	Number of swimmer days exposed (7-27% of swimmers do not comply)	21,068-83,552	404-1,604	2,555-10,133	9,738-38,620	5,830-23,122	39,596-157,030
Exposure before detection	Days of exposure before detection	0	0	4.25	4.25	0	--
	Number of such events per beach	0	0	0.019	0.076	0	--
	Number of days of exposure per year per beach	0	0	0.079	0.323	0	--
	Percent of year	NA	NA	0.022%	0.089%	NA	--
	Number of swimmer days (100 percent swimmers are exposed)	0	0	12,329	138,209	0	150,538
Total number of swimmer days occurring during the contamination period	21,068-83,552	404-1,604	14,884-22,462	147,948-176,830	5,830-23,122	190,135-307,568	

The first five rows of Table J.7 present information from the 1999-2002 BEACH Surveys. On average, 153 CSO- and SSO-related closure/advisory actions were reported in the BEACH Survey at these beaches between 1999 and 2002. The number of swimmer days includes swimmer days at state-recognized beaches not in the BEACH Survey, as described in Section J.5.

The middle section of the table estimates the level of exposure that occurs when non-compliant swimmers are exposed to CSO and SSO contamination. Multiplying this amount of exposure prevention per event by the frequency of such events gives an estimate for the average number of days of exposure per beach per year occurring for noncompliant swimmers. The number of exposed days is then divided by 365 to calculate the percent of the year when contamination is present at a beach. Next, the percent of the year is multiplied by the number of swimmer days and by 7 percent and 27 percent (to account for the range of noncompliance exposure rates) to estimate the total number of swimmer days of exposure to CSO and SSOs during closures and advisories.

The third section of Table J.7 (exposure before detection) estimates the days of exposure occurring during CSO and SSO contamination events before they are detected. In this case, exposure occurs only during the lag time between actual contamination and when the action begins at Category 2B and 3 beaches. Again, the amount of exposure occurring per event is multiplied by the frequency with which such events occur, to estimate the average number of days of exposure per beach per year occurring during the lag-time between contamination and detection. The number of days is divided by 365 to calculate the percent of the year contamination is present at these beaches. This percentage is multiplied by the number of swimmer days to estimate the number of swimmer days of exposure to CSOs and SSOs before the advisories and closings are in effect.

The last row of the table presents the number of exposed swimmer days for the two different scenarios of exposure.

J.8 SSO Events Excluded From Exposure Duration Calculations

Several SSO actions were removed from the exposure duration analysis because they were determined to be non-representative of typical SSO events. Actions were considered to be non-representative of typical SSO events when:

- Action durations were greater than 100 days for a single event.
- Survey entries were found to be erroneous, based on information supplied by the beach authorities or based on internal quality control checks performed by technical reviewers.

Action durations greater than 100 days for a single event were removed from the analysis or adjusted when appropriate, because EPA assumed that such extended SSO contamination likely represented a continuous SSO problem that was well known, and therefore human exposure is less likely. Additional actions were removed from Categories 1 and 2B calculations. By definition, beach actions issued for these categories were issued preemptively. However, closer review of 2001 BEACH Survey responses indicated that several actions for these categories had been issued based on monitoring data alone. The actions in Categories 1 and 2B that were based on monitoring data alone were not included in these category calculations. In addition, these data were not used in any other duration categories. All of the actions (four in total) were removed from Category 2B because they were issued based on monitoring data alone; therefore, no duration estimates could be calculated for this category based on those four actions.

J.9 Pathogen Concentrations

EPA estimated the average level of pathogens at beaches during closures attributed to CSO and SSO events and through analysis of monitoring data obtained from the states and reported in the 2001 and 2002 BEACH Survey. EPA obtained additional monitoring data from relevant state or county websites and by contacting beach authorities. EPA estimated the in-water concentration during an event by averaging monitoring data observations obtained during the event including: the first monitoring result indicating exceedance of the bacteria standard and the presence of contamination, and all subsequent monitoring results until the first monitoring result indicating that bacteria concentrations had fallen to an acceptable level. The monitoring data indicated similar, highly variable bacteria concentrations for both CSO- and SSO-contaminated recreational waters and were therefore averaged.

- For salt water closures/advisories, data were obtained for 26 actions. The average enterococci concentration during these events was 532/100 mL.
- For freshwater closures/advisories, data were obtained for 29 actions. This E. coli concentration was 695/100 mL.

To account for bacteria levels present at times when SSO and CSO events are not occurring, EPA estimated background levels. This was accomplished by averaging concentration levels from the last monitoring result not below the bacteria standard preceding a contamination event at each beach for which there were data. The monitoring data showed similar, highly variable bacteria concentrations for both CSO- and SSO-contaminated

recreational waters and were therefore averaged.

- The average background enterococci concentration was 12/100 mL
- For freshwater the background E. coli concentration was 71/100 mL

J.10 Dose Response Equations

The following dose-response functions derived by Cabelli (1983) and Dufour (EPA 1984) were used by EPA to relate highly-credible gastrointestinal illness (HCGI) symptoms among swimmers to the concentrations of enterococci (for marine water and for freshwater) or E. coli (for freshwater only):

For marine water:

$$\text{HCGI symptoms/1000 swimmers} = 0.2 + 12.17 \log(\text{mean enterococci/100 mL})$$

For freshwater:

$$\text{HCGI symptoms/1000 swimmers} = -11.74 + 9.4 \log(\text{mean E. coli/100 mL})$$

These equations derive from epidemiological studies sponsored by EPA at several beach locations in the late 1970s and early 1980s, and provide the basis for EPA's current water quality criteria for recreational waters. EPA's marine water quality criterion of 35 enterococci per 100 mL, for example, was derived by solving the first equation for the water quality that would yield the traditionally accepted illness rate of 19 cases per 1000 swimmers. Several of Cabelli's and Dufour's findings are notable:

- The clearest statistical relationships between water quality and swimmer illness rates were found for gastrointestinal illness. The statistical relationships were even more definitive when only "highly credible" gastrointestinal symptoms were considered, in contrast to all gastrointestinal symptoms.
- Enterococci (marine water and freshwater) and E. coli (freshwater) were found to be the best indicator parameters. They correlated with swimmer illness rates more closely than did other possible indicator parameters (e.g., fecal coliform).

Despite EPA's adoption of the Cabelli/Dufour dose-response functions as the basis for recreational water quality criteria, a great deal of uncertainty is associated with the number of illnesses predicted by these functions, as discussed above. EPA believes most other studies generally support the Cabelli/Dufour conclusion that enterococci and E. coli are the best indicators (EPA 1984). A comprehensive recent review of epidemiological studies on health effects from exposure to recreational water conclude similarly that enterococci/fecal streptococci for both marine and freshwater, and E. coli for freshwater, correlate best with health outcomes (Pruss 1998).

EPA's Office of Research and Development recently reviewed the Cabelli/Dufour studies and the other swimmer illness studies conducted since 1984, when the last of Cabelli/Dufour's studies were published. The review concluded:

In examining the relationships between water quality and swimming-associated gastrointestinal illness, the epidemiological studies conducted since 1984 offer no new or unique principles that significantly affect the current water quality criteria EPA recommends for protecting and maintaining recreational uses of marine and freshwaters. Many of the studies have, in fact, confirmed and validated the findings of EPA's studies. Thus, EPA has no new scientific information or data justifying a revision of the Agency's recommended 1986 water quality criteria for bacteria at this time (EPA 2002).

In light of these findings, EPA concluded that Cabelli/Dufour remained the most reliable set of dose-response functions available to estimate swimmer illness rates in the United States.

Cabelli and Dufour found a statistically significant relationship between indicator bacteria density and gastrointestinal symptoms for some beaches. However, they found a stronger statistical relationship between indicator bacteria density and HCGI symptoms, and decided therefore to express their preferred dose-response relationship in terms of HCGI symptoms rather than total gastrointestinal symptoms. The implication for this analysis is that the Cabelli/Dufour dose-response relationships may understate by a factor of two to four the total number of gastrointestinal cases that are likely occurring. This factor may result in EPA substantially underestimating the number of illnesses resulting from exposure to beach water contaminated by CSO and SSO discharges.

J.11 Illness Calculations and Results

The number of HCGI illnesses resulting from exposure to beach water contaminated by CSOs and SSOs was estimated by combining information on the number of exposed swimmer-days, the concentration of indicator bacteria to which swimmers are exposed, and the Cabelli/Dufour dose-response functions for marine and freshwaters. Table J.8 shows how the number of illnesses was calculated from the number of person days exposed to beach water contaminated by CSO and SSO discharges at beaches included in this analysis.

Table J.8 Derivation of Number of HCGI Cases

Steps	Water Type (per dose-response functions)	Category					Total
		1	2A	2B	3	4	
Person Days of Exposure		21,068- 83,552	404- 1,604	14,884- 22,462	147,948- 176,830	5,830- 23,122	190,135- 307,568
Allocation of Exposure Days	Percent in marine waters	83	83	83	83	83	83
	Percent in freshwaters	17	17	17	17	17	17
Person Days of Exposure	In marine waters	17,487- 69,348	336- 1,331	12,534- 18,643	122,797- 146,769	4,839- 19,191	157,813- 255,282
	In freshwaters	3,582- 14,204	69- 273	2,530- 3,818	25,151- 30,061	991- 3,931	32,323- 52,287
Pathogen Level During Contamination	Marine waters (EN/100 mL)	532	532	532	532	532	532
	Freshwaters (E. coli/100 mL)	695	695	695	695	695	695
Rate of HCGI Cases	Marine waters (per 1,000 swimmers)	33	33	33	33	33	33
	Freshwaters (per 1,000 swimmers)	15	15	15	15	15	15
Background Pathogen Level	Marine waters (EN/100 mL)	12	12	12	12	12	12
	Freshwaters (E. coli/100 mL)	71	71	71	71	71	71
Rate of HCGI Cases	Marine waters (per 1,000 swimmers)	13	13	13	13	13	13
	Freshwaters (per 1,000 swimmers)	6	6	6	6	6	6
Illness Rate for Contamination Events - Background Levels	Marine waters (per 1,000 swimmers)	20	20	20	20	20	20
	Freshwaters (per 1,000 swimmers)	9	9	9	9	9	9
Number of Primary HCGI Cases	In marine waters	350- 1,387	7- 27	247- 373	2,456- 2,935	97- 384	3,157- 5,106
	In freshwaters	32-128	1-2	23-34	226-271	9-35	291-470
Total estimated primary HCGI occurring due to human exposure to SSO and CSO contamination		382- 1,515	8- 29	270- 407	2,682- 3,206	106- 419	3,448- 5,576

References

- Cabelli, V.J. et al. 1983. A marine recreational water quality criterion consistent with indicator concepts and risk analysis. *Journal of Water Pollution Control Federation* 55(10):1306-1314.
- EPA. 1984. Office of Research and Development. *Health Effects Criteria for Fresh Recreational Waters*. EPA 600/1-84-004.
- May, H., and J. Burger. 1996. Fishing in a polluted estuary: fishing behavior, fish consumption, and potential risk. *Risk Analysis* 16(4):459-471.
- National Sporting Goods Association (NSGA).1992. *Sports participation in 1990, Series I and II*.
- Prüss, A. 1998. Review of Epidemiological Studies on Health Effects From Exposure to Recreational Water. *International Journal of Epidemiology* 27:1-9.
- US DOC, Census (U.S. Department of Commerce, Bureau of the Census). 2004. *State and County QuickFacts*. Retrieved July 28, 2004. <http://www.census.gov>
- Vail, B. J. 2002. *Coastal Beach Water Quality and Public Health: Preliminary Steps Toward Improving Public Notification in Wisconsin Under the Federal BEACH Act*. Wisconsin Department of Natural Resources.

Appendix K

Summary of Enforcement Actions

K.1 Federal CSO Judicial Orders

K.2 Federal SSO Judicial Orders

K.3 Federal CSO Administrative Orders

K.4 Federal SSO Administrative Orders

K.5 Federal CSO Administrative Penalty Orders

K.6 Federal SSO Administrative Penalty Orders

K.7 State CSO Judicial Orders

K.8 State SSO Judicial Orders

K.9 State CSO Administrative Orders

K.10 State SSO Administrative Orders

K.11 State CSO Administrative Penalty Orders

K.12 State SSO Administrative Penalty Orders

K.1 Federal CSO Judicial Orders

Region	State	Case Name/City Name	Effective Date	Description
1	MA	Boston Harbor (MWRA)	1987	MWRA has completed four hydraulic relief projects including, CAM005, BOS017, Chelsea Trunk, and Chelsea Branch. They have completed CSO facility upgrades at Cottage Farm, Prison Point, Commercial Point, Fox Point and Summerville-Marginal. They have completed upgrades to the floatables removal facility and have closed outfalls. Under construction are the East Boston Branch Sewer relief and Union Park Detention/Treatment facility. Sewer separation is proceeding in South Dorchester, Stony Brook and Neponset River. Still in the design phase are Fort Point Channel Storage, the BOS019 storage conduit and parts of the East Boston Branch Sewer relief and, the South Dorchester and Stony Brook separation projects.
1	MA	City of Lowell	11/10/88; Amended 06/29/01	The Consent Decree required that the City complete construction of the Southwest Bank Interceptor Project and eliminate all discharges from outfalls 001 and 003 by 12/15/88. It further required that the City complete construction of the Northwest Bank Interceptor Project, eliminate all discharges from outfalls 005 and 006, and complete construction of Storm Water Diversion Structure Number Two by 09/01/88. The City was required to eliminate all dry weather discharges from its West Street Pump Station by 01/15/89 and also eliminate discharges from outfall 004 by 04/15/89. Finally, they were required to complete construction for rehabilitation of Marginal Street Interceptor and eliminate all discharges from outfall 032 by 01/15/90. The City was required to submit a completed Combined Sewer Overflow (CSO) Facilities Plan to EPA and the Department of Environmental Quality Engineering of the Commonwealth of Massachusetts (DEQE) which would address further CSO abatement.
1	MA	City of New Bedford	12/07/87; Amended - 4/28/95	The Consent Decree required the City to prepare and submit a CSO Facilities Plan by 07/01/89. The Plan identified all of the projects necessary to meet permit requirements and CSO discharge requirements. The City was required to construct whatever projects necessary to eliminate dry weather discharges from CSO outfalls by 03/01/90.
1	MA	Gloucester	11/30/88	The Order addressed noncompliance by failing to complete a CSO study and treatment plan.
1	MA	Lynn Water and Sewer Commission	11/02/89; Amended 11/15/94; Amended 06/29/01	The Order required that by 12/31/03, the Commission would complete construction of the Summer Street Sewer Separation Project and complete 100% of the sewer separation for outfall 006 thereby eliminating discharges of combined sewage to outfall 006. The Order also required that by 12/31/06, the Commission would complete the sewer separation for outfall 005 eliminating discharges of combined sewage to outfall 005. Also, by 12/31/09, the Commission would complete the sewer separation for outfall 004 eliminating discharges of combined sewage to outfall 004.
1	MA	Swampscott	05/05/88	The Order required the completion of a CSO analysis and development of a schedule for construction of CSO facilities.

Region	State	Case Name/City Name	Effective Date	Description
1	ME	City of Bangor	04/09/91; Modified- 06/28/91	The Order required a CSO facility's plan and CSO abatement projects implementation.
1	ME	City of Bangor	6/30/87; Amended 12/01/87	This Order addressed certain NPDES permit violations.
1	ME	City of South Portland	04/16/92; Amended- 08/18/94	This Order required a Publicly Owned Treatment Work (POTW) upgrade and a CSO abatement program for NPDES permit compliance.
1	NH	City of Portsmouth	No date provided	This Order required the implementation of a Long-Term Control Plan (LTCP).
2	NJ	North Bergen Township	No date provided	This Order addressed the failure to meet the construction schedule for CSO abatement.
2	NY	Niagara Falls	03/13/87	This Order required the City to eliminate all dry weather overflows and submit final plans for repairs necessary to the combined sewer system (CSS).
2	NY	Poughkeepsie	03/31/88	This Order required the City to eliminate all dry weather overflows.
2	NY	Utica	06/22/77	This Order required the City to eliminate dry weather overflows and conduct a Sewer System Evaluation Study (SSES).
3	MD	City of Baltimore	09/30/02	The Consent Decree required the City to separate the CSS and eliminate all CSO structures from the Warbrook neighborhood by 06/30/02 and in the Forest Park neighborhood by 06/30/05. This represented elimination of all CSOs in Baltimore.
4	GA	City of Atlanta	07/13/98	The Consent Decree required Atlanta to perform an evaluation of their existing CSO control facilities, perform studies and testing of their CSS and receiving waters and prepare a remedial measures report which will evaluate appropriate alternatives for CSO control. The City was required to perform various other studies to evaluate the efficacy of previous CSO control efforts. The Consent Decree required that the City prepare CSO Management, Operation, and Maintenance Plans by 12/01/98.
4	GA	City of Atlanta	09/24/98	This Order addressed the nonattainment of water quality standards resulting from CSOs and it required an evaluation of CSO discharges and remedial action plan. All construction will be complete by 07/11/14.
4	GA	City of Atlanta	07/29/99	This Order required the City to complete construction for the 10th Ward Trunk Sewer Improvements (Plan 6) by 07/31/00, complete construction for the Fairmont/Glidden CSO Separation by 09/30/01, complete construction for the Phase III Relief Sewer by 08/31/02, complete construction for the Veterans Hospital Trunk Sewer Improvements by 11/30/02, complete construction for the Peachtree Interceptor Relief Sewer by 12/31/02, complete construction for the Pine Meadows Sewer Improvements by 01/31/03, and complete construction for the North Fork Peachtree Creek Relief Sewer and Nancy Creek Sewer System Rehabilitation; the 10th Ward Trunk Sewer Improvements (Part 1-5); the South Fork Peachtree Creek Trunk Relief Sewer; and the Indian Creek Trunk Relief Sewer by 02/28/03.

Region	State	Case Name/City Name	Effective Date	Description
5	IL	Metropolis	No date provided	The Consent Decree required correction of the CSO overflow structure.
5	IL	Paris	No date provided	The Order addressed NPDES permit violations, resulting in CSO separation, testing, and first flush treatment.
5	IL	Rock Island WWTP	08/21/03	The Order addressed permit violations. Rock Island was required to prepare and submit a LTCP. A penalty of \$150,000 was assessed.
5	IN	Anderson	07/18/02	The Consent Decree required that by 12/31/09, they will complete construction for all improvements.
5	IN	City of Bonnaville	04/16/87; Amended 08/13/01	The 1987 Consent Decree required the City to adequately maintain the CSS and improve plant operations.
5	IN	Hammond	04/23/99	The Consent Decree required Hammond to maximize combined sewage flow through the collection system and treatment plant and implement their LTCP. They were directed to construct facilities as needed to eliminate three of their CSOs, including but not limited to: a storage reservoir, pump station improvements, sewer separation, sewer interceptors, and sewer interceptor improvements by 05/01/09.
5	IN	Madison	No date provided	The Consent Decree required development of a CSO management plan.
5	MI	Menominee	04/21/88	The Order addressed unauthorized CSO discharges.
5	MI	Wayne County	1994	The Order addressed CSOs contributing to public health advisories against swimming and nutrient loading stimulating plant and algae growth in downstream water bodies including Lake Erie.
5	OH	Bedford	09/30/85	This Order required City to conduct a CSO facility study and implement a plan for appropriate treatment of CSOs.
5	OH	Cincinnati Metropolitan Sewer District	No date provided	This Order addressed unauthorized dry weather discharges from CSOs.
5	OH	City of Akron	No date provided	This Consent Decree addressed CSOs causing violation of effluent limits and failure to meet schedule for elimination of CSOs.
5	OH	City of North Olmsted	07/31/91	Under this Order they were required to achieve consistent compliance with its permit within 40 days of the Order.
5	OH	Port Clinton	09/08/99	This Order required monitoring and scheduled CSO abatement. Port Clinton was required to submit a plan for permanent CSO improvement or closure by 11/01/99.
5	OH	Portsmouth	1992	This Order addressed CSOs causing water quality standard exceedances in the Scioto and Ohio Rivers.
5	OH	Toledo	12/19/02	The Toledo Consent Decree addressed both CSO issues and Sanitary Sewer Overflow (SSO) issues. Regarding CSOs, Toledo was required to design and construct certain "Phase I" CSO control measures including: East Side and Bay View Pump Stations improvements, secondary treatment backup power, a 60 MG equalization basin, an additional secondary clarifier, and a 185 MGD capacity ballasted flocculation wet weather treatment system. These "Phase I" projects were estimated to cost \$157 million, and were to be complete within approximately 40-45 months of decree entry (depending on plan review and approval). Toledo was also required to develop and implement a LTCP. The LTCP control measures were to be completed by August 2016.

Region	State	Case Name/City Name	Effective Date	Description
5	OH	Wellston	10/13/87	This Order addressed CSO discharges due to improper Operation and Maintenance (O&M) and unpermitted bypasses.
5	OH	Youngstown	03/05/02	Youngstown was required by the Consent Decree to: eliminate an outfall in a local park (Outfall 6108) by 05/06; eliminate two small direct sewage discharges ("Tod & Irving East & West") by 08/03; develop a LTCP by 01/03; remove accumulated sediment from the Mill Creek Collector Sewer by 06/02; and implement various short-term operational (i.e., Nine Minimum Controls (NMCs)) improvements and pump station upgrades/ replacements by 2007.

K.2 Federal SSO Judicial Orders

Region	State	Case Name/City Name	Effective Date	Description
1	CT	Greenwich	01/15/02	This Consent Decree required that construction be complete by 12/08.
1	CT	Waterbury	11/21/02	The Consent Decree was issued to prevent future Sanitary Sewer Overflows (SSOs) from occurring. Multiple construction schedules were established in the Order and were pending EPA approval.
1	MA	Winchendon	07/29/02	This Consent Decree required that construction for the SSO improvements be complete by 01/04 and construction for the Publicly Owned Treatment Works (POTW) improvements be complete by 07/05.
2	Puerto Rico	Puerto Rico Aqueduct and Sewer Authority (PRASA)	Lodged 03/13/03	This Consent Decree required specific remedial actions at a defined list of pump stations. PRASA was required to submit the detailed list of actions to be performed at each station and a proposed schedule for same, within 90 days of entry date of Consent Decree. All remedial actions at these stations were to be complete within 32 months of the date of final approval of the list. All pump stations were to be subject to an Operation and Maintenance (O&M) plan, which was to be developed by PRASA. A Spill Response and Cleanup Plan was required to be submitted within 90 days of date of entry of Consent Decree. The Plan was to be reviewed annually and updated as necessary.
3	MD	City of Baltimore	09/30/02	Remedial actions included: elimination or modification of designated SSO structures; reporting of SSO events; identification of all SSO structures, flow monitoring, collection system evaluation and sewershed planning, Infiltration and Inflow (I/I) evaluation; elimination of cross connections between sanitary and storm sewers; peak flow modeling; inspection of all gravity sewers 8-inches and larger and all force mains, manholes, etc.; evaluation of long-term capacity; identification and elimination of illegal private connections; rehabilitation of certain pump stations; inspection of all pump stations twice daily until SCADA is installed; update of maintenance information management system; performing pump station preventive maintenance; updating existing O&M manuals; implementing a maintenance program for the collection system and an overall information management system program; inspection of all valves in the collection system; development of an Emergency Response Plan; and reporting both orally and in writing any unauthorized discharges to waters.
3	PA	Borough of Indiana	06/17/02	Objectives of the Consent Decree included compliance with final effluent limits, elimination of bypasses at the treatment plant, and elimination of SSOs. The remedial action for SSO elimination was to implement the EPA-approved SSO Response Plan that was previously submitted. With regard to the other issues, by 07/01/03, the Borough was supposed to have completed the wastewater treatment plant expansion projects, including the entire Wastewater Detention Tank. The Borough was also supposed to complete the Main Plant Interceptor project by 08/01/03.
3	PA	Bradford	04/11/03	This Consent Decree addressed NPDES permit violations and assessed a \$40,000 civil penalty.
3	VA	Galax	01/30/03	This Consent Decree required the City to implement a Comprehensive Management, Operation and Maintenance (CMOM) program. All construction was to be complete by 03/03.

Region	State	Case Name/City Name	Effective Date	Description
4	AL	Jefferson County	12/15/96	The Consent Decree laid out a three-phase plan. Phase I required the County to develop a series of planning documents that would identify the scope, methodologies, time frames, and resources to be allocated to evaluate the condition and capacity of the collection system, identify sources of I/I, and develop remedial measures. Phase II consisted of analyses and reports to determine the extent of rehabilitative needs and corrective actions necessary. Phase III was the implementation phase, in which specific improvements were to be made according to the Capacity Improvement Schedules and the Performance Improvement Plans developed in Phase II.
4	AL	Mobile	01/24/02	The Consent Decree required them to develop both Short-Term and Long-Term Capacity Assurance Programs. They were required to implement an EPA-approved SSO Reporting, Notification, and Record Keeping Program and submit a semi-annual report to EPA analyzing information available through its information management systems. They were also required to submit and implement Legal Support Programs, including an ordinance for grease control, as well as develop and submit a Contingency Plan for Sewer and Wastewater Treatment Facilities. They also had to submit and implement the following programs: Scheduled Pump Station Operation Program, Electrical Maintenance Program, Mechanical Maintenance Program, Force Main Preventive Maintenance (PM) Program, Gravity Line PM Program, Scheduled Hydraulic Cleaning Program, Root Control Program, Unscheduled Maintenance Program, revised Grease Control Program. A wet weather and dry weather water quality monitoring program was also required.
4	FL	Miami-Dade (Second and Final Partial Consent Decree)	04/95	This Consent Decree required an I/I evaluation and rehabilitation program; identification of a service area for each pump station; complete evaluations of 6.96 million feet of sewer lines and associated manholes; addressing I/I on private property; identification and elimination of illegal storm sewer connections to the sanitary sewer; development of a program to identify illegal storm sewer connections; inspection and, where necessary, repair of each pump station; repair or other improvements to pump stations that caused or contributed to SSOs; completion of the installation for the online remote monitoring equipment; submission of a Short-Term Collection System Operating Plan and a Long-Term Collection System Operation Plan; development of and implement a computerized collection and transmission system model; development of a program of pump station upgrades and collection system improvements; implementation of a collection system maintenance program; development of an inventory management system; and develop a program to optimize wastewater treatment efficiency and effectiveness.
4	GA	City of Atlanta	12/20/99	This Consent Decree required that construction for all improvements be complete by 07/01/14.

Region	State	Case Name/City Name	Effective Date	Description
4	GA	City of Atlanta	07/29/99	This Consent Decree required the City to complete construction for the 10th Ward Trunk Sewer Improvements (Plan 6) by 07/31/00, complete construction for the Fairmont/Glidden CSO Separation by 09/30/01, complete construction for the Phase III Relief Sewer by 08/31/02, complete construction for the Veterans Hospital Trunk Sewer Improvements by 11/30/02, complete construction for the Peachtree Interceptor Relief Sewer by 12/31/02, complete construction for the Pine Meadows Sewer Improvements by 01/31/03, and complete construction for the North Fork Peachtree Creek Relief Sewer and the Nancy Creek Sewer System Rehabilitation, the 10th Ward Trunk Sewer Improvements (Part 1-5), the South Fork Peachtree Creek Trunk Relief Sewer, and the Indian Creek Trunk Relief Sewer all by 02/28/03.
4	GA	City of Atlanta	07/13/98	This Consent Decree addressed violations of its NPDES permits by discharging untreated wastewater containing raw sewage and partially treated wastewater into the Chattahoochee and South Rivers and their tributaries.
4	GA	Dalton	Lodged 01/18/01; Entered 03/28/01	This Consent Decree covered SSO, sludge, land application, and pretreatment. Construction was expected to be complete by 12/03.
5	IN	New Albany	06/18/93; Amended 05/03/02	This amended Consent Decree required the City to develop a computerized collection system model, a SSO response plan, and a capacity assurance plan. They were also required to identify and remove all I&I sources unless exempted by EPA, perform wet weather survey and sampling, identify and remove any cross connections, and remove or separate any combined sewers. The capacity assurance plan included proposed remedial measures and a schedule for their design and construction. A comprehensive preventive maintenance program and a grease control program were also required to be developed and implemented. All piped overflows were to be flow metered. Flow volumes and rates of sanitary sewage input to a flood control pump station were to be estimated and sampled, and results submitted to EPA. Bypasses at these locations were to be reported to EPA within 24 hours. Alternative power sources and lightning protection at pump stations were to be provided to prevent overflows and the City was required to demonstrate for one year that all capacity related overflows had been eliminated.
5	IN	South Haven Sewer Works	Lodged 07/17/03	This Consent Decree addressed permit violations.
5	OH	Akron	07/28/95	This Consent Decree required them to have construction complete for all improvements by 12/31/96.

Region	State	Case Name/City Name	Effective Date	Description
5	OH	Hamilton County (Interim Partial Consent Decree)	Lodged 02/15/02	This Consent Decree required Interim Remedial Measures (IRM) to include expenditure of \$10-\$15 million on an overflow treatment and storage facility for "SSO 700" and development of an IRM Plan evaluating system, including cost/performance, design storm parameters, etc., and schedule for completion by no later than 12/31/07. After its completion, the County was to conduct an Effectiveness Study of the treatment and storage facility. Permanent Remedial Measures included a Remedial Plan due 12/31/09, with a goal of eliminating the "SSO 700" discharge point. The Remedial Plan was to specify proposed measures, estimated costs, annual O&M costs and expected performance during various storms. It also required a Comprehensive SSO Remediation Program to deal with SSOs in other parts of the system. This included modeling, capacity assessment, SSO response program, SSO monitoring and reporting plan, pump station operation program, industrial waste SSO/CSO management, etc.
5	OH	Toledo	12/19/02	This Consent Decree addressed NPDES permit violations, including failure to implement a Long-Term Control Plan (LTCP). They were required to have construction complete for all improvements by 12/16. This Consent Decree only addressed those that were point source discharges to waters, referred to as Sanitary Sewer Discharges (SSDs). Provisions that apply to SSDs include performing a Sanitary Sewer Evaluation Study (SSES), development of schedule for construction of sanitary sewer improvements; elimination of all known points of illegal discharge by 11/01/06; development of a Separate Sewer System Monitoring and Reporting Plan; development of an SSD response plan; development of an Industrial Wastewater Release Minimization Plan to reduce discharge of industrial pollutants through SSDs; and development of a Sewer System Management, Operation and Maintenance Plan to include gravity sewers, force mains, pump stations.
6	LA	City/Parish of East Baton Rouge	12/23/88; Modified 07/23/97	Remedial measures in this Consent Decree included elimination of cross connections, development of preventive maintenance program and SSO response plans, reporting unauthorized discharges, and monitoring environmental results. Also, a collection system remedial program was to be selected and completed. The components of this program were to include construction of storage basins and tanks, construction, modification or elimination of pump stations, construction of deep underground sewers and construction of treatment facilities. A treatment facility assessment was to be performed to evaluate whether improvement or expansion of three existing plants, or changes in plant O&M, were needed to comply with NPDES permits and handle future loading.
6	LA	City/Parish of East Baton Rouge	03/14/02	The environmental benefit of this Consent Decree was that 1.2 billion gallons will be eliminated annually. A \$1.12 million SEP was to be performed by the City and a penalty of \$945,500 was assessed.

Region	State	Case Name/City Name	Effective Date	Description
6	LA	New Orleans	04/08/98	This Consent Decree required the Board to operate the fluidized bed incinerator with the EPA-approved O&M plan, have backup pumps for the pump stations, have the SCADA installed at all but one of the pump stations, operate a 24-hour manned central dispatch center, and certify that most known cross connections have been permanently sealed. Some cross connections were permitted to be retained, for these, the Cross Connection Security Plan would be followed and a physical barrier such as a valve or gate would be between the storm and sanitary sewers. They were also required to comply with the EPA-approved Preventive Maintenance Program and the Sewer Overflow Action Plan, track and report all unauthorized discharges, undertake a Remedial Action Program which would include flow monitoring, development of a computerized model, identification of construction projects, performance of collection system evaluation studies, and development of a Remedial Measures Action Plan (RMAP). Additionally, they will develop a storm sewer monitoring program.
9	CA	San Diego	06/09/97 Judicial ruling as to liability and penalties, settlement and injunctive relief	This Consent Decree required them to have all construction complete by 12/07.
9	HI	Honolulu	05/15/95	This Consent Decree required implementation of the EPA-approved pretreatment program, and included a requirement to develop technically based local limits for any pollutants of concern. They were also required to submit annual goals for reduction of SSOs for the years 1994 through 1999, and submit a Spill Reduction Action Plan by 12/31/95. This Plan was to include a Preventive Maintenance Plan, procedures for conducting grease trap inspections, evaluation of staffing needs, and equipment inventory. Interim preventive maintenance activities were also specified, including inspection and cleaning of at least 300 miles of sewer per year, semi-annual grease trap inspections, and inspection and cleaning of SSO hot-spots. Additionally, they were required to implement a computerized wastewater information and management system by 12/31/95 and developed an I/I program to prevent wet weather overflows.
9	HI	Maui	09/09/99	This Consent Decree required the County to submit a Spill Reduction Action Plan (SRAP) to include implementation schedules, a spill response plan, a sewer preventive maintenance plan, a pump station spill reduction plan, an employee training program, a Fats, Oil, and Grease (FOG) control program, and a construction spills prevention plan by 01/01/00. They were also required to update its information management system to include systematic recording of collection system O&M activities and information obtained from sewer inspections and grease interceptor inspections and implement a Long-Term Sewer Line System Analysis and Rehabilitation Plan. A long-term treatment plant and pump station plan was required for rehabilitation, replacement and expansion of these facilities. Both of these plans have varying schedules depending on area and quarterly reporting.

K.3 Federal CSO Administrative Orders

Region	State	Case Name/City Name	Effective Date	Description
1	MA	Chicopee WPCF	06/06/97	This Order required them to complete construction of eliminating dry weather overflows at CSOs 027 and 037 and to complete river inflow improvements. Chicopee WPCF has constructed a CSO related bypass at the WWTP, allowing additional wet weather flow to receive primary treatment at the WWTP, thereby reducing CSOs.
1	MA	Chicopee WPCF	06/03/99	The Order required them to complete construction to eliminate dry weather overflows at CSO 027 (Front Street), CSO 037 (East Main Street), and River inflow improvements and to complete the cleaning of the second siphon at CSO 024 (V).
1	MA	City of Chicopee	09/95	This Order required an abatement schedule for CSOs to Connecticut River.
1	MA	City of Fall River	1987	This Order addressed unauthorized CSO discharges.
1	MA	City of Fall River	1988	This Order addressed unauthorized CSO discharges.
1	MA	City of Fall River	05/05/90	This Order required submittal of a report detailing the causes of the violations, including recommendations for bringing the discharge into compliance with the permitted limitations and a schedule for implementing the recommendations and achieving full compliance.
1	MA	City of Fall River	08/29/91	This second Order required a detailed engineering report evaluating the City's ability to comply with the NPDES permit requirements.
1	MA	City of Fall River	05/05/94	This third Order required, among other things, that the City submit a plan and schedule for bringing its discharge into compliance by 11/01/95.
1	MA	City of Fall River	05/05/97	Under this Order, the City was required to complete construction and attain operational level of the dechlorination system to comply with the permits effluent limits for total residual chlorine and coliform.
1	MA	City of Fitchburg	08/31/94	This Order required them to submit a scope of work and an implementation schedule to complete a Long-Term Control Plan (LTCP).

Region	State	Case Name/City Name	Effective Date	Description
1	MA	City of Fitchburg	02/2/96; Amended 07/02/96	This Order required the immediate implementation of the Nine Minimum Controls (NMCs), submission of a report documenting NMC implementation by 07/31/96, submission of a draft Long-Term Control Plan by 04/30/98, submission of a final LTCP by 08/29/98, and then implementation of the approved LTCP. The City is proposing separation.
1	MA	City of Fitchburg	12/01/00	This Order required that the City identify appropriate measures to prevent all dry weather CSO discharges from the Collection System. The Order required the City to submit a report that described those measures and provided a schedule for their implementation "as soon as possible". The report was to be submitted within 30 days of receipt of the Order.
1	MA	City of Haverhill	08/09/99	This Order addressed CSO discharges in violation of permit requirements. The Order required the City to complete and submit to EPA and MADEP a draft LTCP by 08/31/00, and a final LTCP by 01/15/01.
1	MA	City of Haverhill	12/17/01, supersedes 11/02/01	The Order required the City to submit a Final LTCP by 08/02/02. The Order also required the City, by 04/01/03, to submit plans and specifications to EPA for: a parallel force main, measures to increase the WWTP peak wet weather capacity (through primary treatment), and primary bypass disinfection. Once approved by EPA, the City was to implement these measures within 28 months. The Order also required the City to submit plans for the structural modifications of Bradford-Side CSOs by 05/03/03, and complete those modifications within 15 months. The Order also required submission and implementation of a CS monitoring program.
1	MA	City of Holyoke	12/08/00	The Order required the City to complete construction of the Green Brook Sewer Separation Project, remove Green Brook flow from the combined sewer system (CSS) and eliminate all dry weather overflows from CSO discharge points.
1	MA	City of Holyoke	04/11/01	The Order required the City to complete construction of Day Brook detention basin project and complete construction of the upgrade to the wastewater treatment facility.
1	MA	City of Holyoke	09/95	Under this Order, they were required to prepare an abatement schedule for CSOs to Connecticut River.
1	MA	City of Holyoke WPCF	03/27/97	This Order required the City to: initiate the appropriation of funds needed to complete the LTCP by 04/15/97; complete the appropriation of those funds by 05/06/97; submit a SRF application by 06/01/97; submit to EPA and MADEP a CSO monitoring plan by 08/01/97; begin implementing the CSO monitoring plan by 09/01/97; submit to EPA and MADEP a CSO optimization plan by 10/01/97; complete implementation of the CSO monitoring plan by 06/30/98; complete implementation of the CSO optimization plan by 03/01/99; complete calibration of a computer model of the collection system by 03/31/99; submit to EPA and MADEP a draft LTCP by 10/01/99; and submit a final LTCP to EPA and MADEP by 04/01/00.

Region	State	Case Name/City Name	Effective Date	Description
1	MA	City of Taunton	01/29/96	The Order required the City to submit to EPA and to the Massachusetts Department of Environmental Protection (MADEP) a revised Scope of Work for conducting long-term improvement projects addressing Infiltration and Inflow (I/I) reduction, combined sewer overflow (CSO) abatement, and the Wastewater Facilities Capital Improvements Plan, all by 02/15/96. The Order also required the implementation of short-term improvements including: installation of a tide gate on the Water Street CSO by 03/01/96, submission of a high flow management plan by 03/15/96, updating of the sewer mapping system by 05/01/96, and submission of collection system and WWTP operating budgets by 05/01/96.
1	MA	City of Worcester	09/18/00	The Order required the City to submit a Scope of Work for development of a Phase I LTCP within 4 weeks of the Order date. The Order required submission of the Phase I LTCP within one year of EPA and MADEP approval of the LTCP SOW. The Phase I LTCP was to include a SOW for development of a Phase II LTCP. Submission of the Phase II LTCP was required 12 months following approval of the Phase I LTCP by EPA and MADEP.
1	MA	Gloucester	1989	The 1989 Consent Decree required a LTCP development. The LTCP was received 04/01.
1	MA	Greater Lawrence Sanitary District, North Andover	06/24/99	This Order required the District to submit to USEPA and MADEP a revised NMC report, and to develop and submit to EPA and MADEP for approval, draft (due 06/31/01) and final (due 12/31/01) LTCP report.
1	MA	Massachusetts Water Resources Authority (MWRA)	05/13/96	Under this Order, they were required to plan and implement actions to attain water quality standards.
1	MA	Springfield Water and Sewer Commission, Springfield	04/26/02	This Order required the Commission to: submit a BMP Plan for the Watershops Pond by 03/31/02; submit a final LTCP to EPA and MADEP by 03/15/03; and complete construction of the approved Chicopee River CSO abatement program by 11/15/07.
1	MA	Springfield Water and Sewer Commission, Springfield	09/95	This Order required an abatement schedule for CSOs to Connecticut River.
1	MA	Springfield Water and Sewer Commission, Springfield	03/21/97	The Order required the Commission to: secure funding necessary to develop and implement the LTCP by 04/01/97; submit to EPA and MADEP a report documenting implementation of the NMCs by 04/15/97; submit to EPA and MADEP a CSO monitoring plan and LTCP Work Plan by 07/01/97; engage a consultant to develop the LTCP by 08/15/97; begin implementing the CSO monitoring plan by 03/01/98; complete implementation of the CSO monitoring plan by 06/30/98; complete calibration of a computer model of the collection system and submit to EPA and MADEP a draft LTCP by 05/31/99; and submit a final LTCP by 08/31/99.

Region	State	Case Name/City Name	Effective Date	Description
1	MA	Springfield Water and Sewer Commission, Springfield	11/14/00	Under this Order, the Commission was required to begin construction of interceptor relief conduits and a local storage conduit for CSO 019 by 06/01/02; complete construction of those interceptor relief conduits and local storage conduit for CSO 019 by 12/31/03. Additionally, the Order required the Commission to begin improvements to the York Street Pump Station by 03/01/01; begin improvements to the Union Street Pump Station by 02/01/02; and, complete the pump station improvements by 03/01/04. The City was required to submit a final LTCP by 03/15/02.
1	MA	Town of Agawam	09/21/95	Under this Order, the Town was required to submit a Scope of Work and schedule for CSO facilities planning activities.
1	MA	Town of Agawam	12/30/96	Under this Order, the Town was required to submit a report documenting its implementation of the NMCs by 03/30/97. Following completion of the then-ongoing Little Canada Sewer Separation Project, the Town was then required to implement its existing CSO monitoring plan. Following completion of monitoring, the Town was then required to either submit a plan for additional CSO control, or for the sealing of all CSOs.
1	MA	Town of Ludlow	09/95	This Order required an abatement schedule for CSOs to Connecticut River.
1	MA	Town of Ludlow WTP	12/30/96	Under this Order, they were required to submit a report on the implementation of the NMCs as part of controlling discharges from its CSOs. The Town will implement the CSO monitoring plan.
1	MA	Town of Palmer	01/06/97	This Order addressed CSO discharges in violation of permit and a penalty of \$5,000 was assessed.
1	MA	Town of South Hadley	09/95	This Order required an abatement schedule for CSOs to Connecticut River.
1	MA	Town of South Hadley, WTP	03/14/97	This Order required the Town to: apply for SRF funds by 03/31/97; complete construction of the Falls Sewer Separation Project by 05/03/99; submit plans and a schedule for the East Side sewer separation project by 03/14/98 ; and complete construction of the Mount Holyoke I/I project, the Silver Street catch basin elimination project, and eliminate CSOs #10 and #14 all by 01/01/01.
1	MA	West Springfield	09/01/95	This Order addressed CSO discharges in violation of permit. The Order required a CSO abatement schedule.
1	ME	Augusta Sanitary District	07/20/97	This Order required the District to: complete "Phase I" WWTP wet weather flow capacity improvement projects by 10/31/98; and complete adjustments to the regulators tributary to CSOs 010, 019, 023, 032, and regulators 029B, 029C, 029D, 029E, 029F, and 029G by 08/01/95. Where those adjustments and "flow slipping", are insufficient to control CSOs, the District must complete separation projects by 06/01/98.

Region	State	Case Name/City Name	Effective Date	Description
1	ME	Biddeford	04/22/94	This Order required a CSO abatement schedule.
1	ME	City of South Portland	11/10/97	Under this Order, the City was required to not bypass secondary treatment at flows less than 22.9 MGD. Bypassing was to occur in accordance with a "High Flow Management Plan" approved by MEDEP. Bypassed flow was to receive the equivalent of at least primary treatment and be disinfected during the disinfection season. This requirement was to remain in effect until either: the permit was modified to incorporate a generic bypass provision; expiration of that permit; compliance by the blended effluent with secondary limits; or elimination of the need to bypass as a result of the sewer separation phase of the CSO abatement project.
1	ME	Lincoln Sanitary District	12/17/98	Under this Order, the District was required to implement the collection system and wastewater treatment facility (WWTF) improvements and CSO abatement projects in accordance with the approved Implementation Schedule. Immediate and continued compliance with the NMCs was also required. Also under this Order, the District was required to not bypass secondary treatment at flows less than 2.8 MGD (instantaneous flow) or 1.07 MGD (daily average flow). Bypassing was to occur in accordance with a "High Flow Management Plan" approved by MEDEP. Bypassed flow was to receive the equivalent of at least primary treatment and be disinfected during the disinfection season. This requirement was to remain in effect until either: the permit was modified to incorporate a generic bypass provision; compliance by the blended effluent with secondary limits; or elimination of the need to bypass as a result of sewer separation projects.
1	ME	Sanford Sewerage District, Town of Sanford	07/13/98	The Order required the District to submit a "Draft CSO Master Plan" within 180 days of receipt of the order, and further required completion of the approved Master Plan in accordance with the schedule included therein. Immediate and continued compliance with the NMCs was also required.
1	NH	City of Nashua	04/16/99	Under this Order, the City was required to implement the construction of specified combined sewer separation projects, as well as to implement a yet-to-be-completed Combined Sewer Separation Plan (due within five years of the Order's effective date). The City will eliminate all CSOs by 2019. The City was also required to revise and implement its WWTF High Flow Management plan.
1	NH	City of Portsmouth	07/11/02	This Order required the City to submit a LTCP and an updated NMC plan by 08/01/02. The City was required to submit a preliminary design report for the CSO measures recommended by the LTCP by 02/08/03, and advertise for bids for the construction of a particular project in the vicinity of Outfalls 010A and 010B by 03/03/03 (two of the three CSOs in the City's CS).

Region	State	Case Name/City Name	Effective Date	Description
1	NH	Lebanon WWTP & City STP	06/06/00	The Order required them to design and construct combined sewer separation projects to eliminate six CSOs (CSOs 010, 027, 026, 005, 022, and 023) by 12/31/08. Additionally, the City was required to submit a plan to EPA to eliminate the seventh CSO (CSO 024) by 12/31/12.
1	NH	Manchester STP	03/08/99	Action was taken to address nonattainment of water quality standards caused by CSOs. The Order required the City to submit plans and specifications for WWTP wet weather treatment modifications within 6 months of the Order's effective date, and to complete construction of those modifications within 12 months of plans and specifications approval. Completion of specified CSO abatement projects ("Phase I" projects) within 10 years of the Order's effective date, completion of a study of CSO #44 within 5 years of Order issuance, provision of a revised ("Phase II") LTCP within 11 years of the Order's effective date, and a \$5.6 million supplemental environmental project (SEP) were also required.
1	NH	Town of Exeter	02/03/97	The Order required the City to submit a report documenting the Town's implementation of the NMCs by 04/30/97.
3	PA	Connellsville Municipal Authority	09/30/02	Under this Order, the Authority was required to provide, within 15 days, an explanation of actions taken to comply with the CSO policy's NMCs requirements and to implement the Authority's existing NMCs Report. Within 30 days, the Authority was required to submit a detailed plan and schedule for fully implementing the NMCs. The order also required the Authority to, within 30 days, identify the resources needed to properly operate and maintain collection system, and to describe any actions the Authority was planning to take to further minimize CSO discharges and water quality impacts.
3	PA	Export Borough	05/15/97	This Order addressed the Borough's failure to obtain and implement the requirements in the CSO general permit. This Order required the Borough to apply to PADEP for a NPDES permit for CSO discharges.
3	PA	Lower Lackawanna Valley Sewer Authority (LLVSA)	12/06/01	This Order required the Authority to submit, within 60 days of receipt of the order, a plan and schedule that identified specific measures to eliminate dry weather overflows. The Authority was required to submit, within 60 days, a plan and schedule detailing how the Authority was expected to fulfill the CSO-related monitoring requirements in its NPDES permit. The Authority was also required to submit, within 180 days, a report identifying critical CSO points and identifying root causes and preventive measures to prevent and/or minimize the impact of discharges from the critical CSO points. Within 45 days of each submittal, the Authority was required to implement that plan.

Region	State	Case Name/City Name	Effective Date	Description
3	PA	Pittsburgh Water and Sewer Authority	11/20/96	This Order addressed the Authority's failure to obtain and implement the requirements in the CSO general permit. This Order required the Authority to apply to PADEP for a NPDES permit for CSO discharges.
3	PA	Scranton	11/27/02	Under this Order, they were required to submit appropriate documentation demonstrating implementation of and compliance with the 1998 NMCs Plan. They were also required to complete and submit to the Pennsylvania Department of Environmental Protection (PADEP) and EPA a revised LTCP and a schedule for implementation.
3	WV	City of Marmet	09/04/02	The Order required the City to submit within 60 days: a plan and schedule for complying with the water quality monitoring requirements of its NPDES permit, and a plan and schedule for reducing I/I levels in the collection system.
3	WV	City of McMechan	09/30/02	The Order required the City to submit within 60 days plans and schedules for complying with: the water quality monitoring requirements of its NPDES permit, the collection system O&M provisions of its NPDES permit, the pollution prevention requirements of its NPDES permit, and the CSO monitoring and characterization requirements of its NPDES permit. The Order required implementation of each of these plans within 90 days of the issuance of the order.
3	WV	Kenova	06/10/03	No additional information provided.
5	IL	City of Lawrenceville	09/30/02	The Order required City to construct and operate an oil collection device at the storm sewer outfall to ensure the discharge of oil and pollutants is minimized. Upon completion and after proper operation of the new replacement sewer, the City had the option of removing the oil collection device. The City was also required to submit a New Sewer Work Plan to EPA by 10/30/02, and shall complete construction by 10/30/03.
5	IL	City of Rock Island	02/13/98	This Order addressed CSOs to environmentally sensitive areas and failure to implement the NMCs. The Order also required plant and sewer improvements to reduce CSOs.
5	IN	Bluffton POTW	06/06/00	The Order addressed failure to submit CSO plan. An Administrative penalty order required a SEP and assessed a \$60,000 penalty.
5	IN	Bluffton Utilities	03/19/98	The Order addressed permit violations.
5	IN	Fort Wayne	1995 and 1996	The Order required them to identify all CSO outfalls and to submit a sanitary sewer overflow (SSO) elimination plan and implement the SSO elimination plan.
5	OH	Columbus WWTP	07/17/98	The Order addressed permit violations.
5	OH	Port Clinton	1995	The Order addressed CSOs in violation of permit. This Order eventually resulted in a judicial referral.

K.4 Federal SSO Administrative Orders

Region	State	Case Name/City Name	Effective Date	Description
1	MA	Town of Winchendon	10/16/00	This Order required the permittee to implement a block testing program to determine the frequency of Sanitary Sewer Overflow (SSO) occurrence and report these results to EPA and Massachusetts Department of Environmental Protection (MADEP). The order also required that an update to the 1998 Preliminary Design Report be submitted to include recommendations on measures necessary to ensure compliance with the NPDES permit.
2	Puerto Rico	PRASA Bayamon WWTP	11/20/02	The order required that Puerto Rico Aqueduct and Sewer Authority (PRASA) take immediate steps to unclog and clean all sewer pipelines and manholes causing sewage bypasses.
2	Puerto Rico	PRASA Bayamon WWTP	12/23/02	The order required that PRASA take immediate steps to unclog and clean all sewer pipelines and manholes causing sewage bypasses
2	Puerto Rico	PRASA Puente Blanco Pump Station & Collection System	12/23/02	A \$104,000 penalty was assessed for failure to provide proper operation and maintenance leading to the discharge of partially or untreated pollutants to waters of the U.S.
2	Puerto Rico	PRASA Puente Blanco Pump Station & Collection System	01/16/01	The Order addressed NPDES permit violations.
3	PA	Prospect Borough	04/27/01	This Order required them to install and operate the flow equalization tank to eliminate overflows of their sewage. The Order further required the City submit a detailed Compliance Plan, conduct an SSES and establish actions to address deficiencies detected in the SSES, and establish a comprehensive management, operation and maintenance (CMOM) program.
4	KY	City of LaGrange	05/09/01	The Order required them to establish numerous programs and evaluate and revise existing programs to achieve continuous compliance with its Permit.
4	KY	City of Radcliff Sewerage System	05/09/01	The Order required them to establish engineering, continuing sewer assessment, infrastructure rehabilitation, system capacity assurance, and pump station operation programs and to evaluate and revise existing programs to remediate the causes of the discharges of untreated pollutants to waters of the U.S.

Region	State	Case Name/City Name	Effective Date	Description
4	MS	City of Moss Point Sewer System	09/28/01	The Order required them to establish numerous programs with respect to collection system assessment, operations and maintenance, and evaluate and revise existing programs to achieve continuous compliance with the Permit.
4	MS	City of Ocean Springs	06/05/01	The Order required them to establish numerous programs with respect to collection system assessment, operations and maintenance, and evaluate and revise existing programs to achieve continuous compliance with the Permit.
4	MS	City of Pascagoula Sewer System	12/04/01	The Order required them to establish numerous programs with respect to collection system assessment, operations and maintenance, and evaluate and revise existing programs to achieve continuous compliance with the Permit.
4	MS	City of Pass Christian Sewerage System	09/09/02	The Order required them to establish numerous programs with respect to collection system assessment, operations and maintenance, and evaluate and revise existing programs to achieve continuous compliance with the Permit.
4	MS	Gautier Utility District Sewer System	03/26/01	The Order required them to establish numerous programs with respect to collection system assessment, operations and maintenance, and evaluate and revise existing programs to achieve continuous compliance with the Permit.
4	SC	City of Simpsonville	02/04/03	The Order required them to establish numerous programs with respect to collection system assessment, operations and maintenance, and evaluate and revise existing programs to achieve continuous compliance with the Permit.
4	SC	City of Travelers Rest	11/15/02	The Order required them to establish numerous programs with respect to collection system assessment, operations and maintenance, and evaluate and revise existing programs to achieve continuous compliance with the Permit.
4	SC	Diamondhead Water & Sewer District Sewer System	10/18/02	The Order required them to establish numerous programs with respect to collection system assessment, operations and maintenance, and evaluate and revise existing programs to achieve continuous compliance with the Permit.
4	SC	Fountain Inn	06/27/02	The Order required the City to review, evaluate, and revise its current Management Program. Additionally, a Training Program, a Safety Program, and the Engineering Program were to be revised and/or developed within 18 months.
4	SC	Gantt	04/29/03	No additional information provided.
4	SC	Georgetown	04/01/03	No additional information provided.
4	SC	Greer	03/20/03	No additional information provided.
4	SC	Laurens County Water and Sewer Commission	08/12/02	The Order required them to establish numerous programs with respect to collection system assessment, operations and maintenance, and evaluate and revise existing programs to achieve continuous compliance with the Permit.
4	SC	Marietta Water, Fire, Sanitation and Sewer District	09/06/02	The Order required the City to review, evaluate, and revise its current Management Program. Additionally, a Training Program, a Safety Program, and the Engineering Program were to be revised and/or developed within 18 months.
4	SC	Piedmont	05/27/03	No additional information provided.
4	SC	Taylors	03/04/03	No additional information provided.
4	SC	Wade Hampton Fire and Sewer District	12/16/02	The Order required them to develop a financing and cost analysis program and a contingency plan for sewer.
4	TN	Rockwood Water and Gas	02/19/02	The order required review, evaluate, revise and/or develop collection system management programs, including Pump Engineering Programs. The City was required to maintain a Pump Station Maintenance and Grease Control Program.

Region	State	Case Name/City Name	Effective Date	Description
4	TN	West Knox Utility District	10/29/01	The order required the establishment of numerous collection system management programs, including the Information Management Systems/Programs and Engineering Programs, to be implemented within 12 months.
5	IL	City of Rock Island, Rock Island	02/13/98	The Order required that a plan of action for achieving compliance must be submitted to EPA for approval within 11 months
5	IN	Fort Wayne	01/17/96	The order required the City to prepare and submit an SSO elimination plan to be implemented upon approval or within 45 days of submittal, whichever came first.
5	IN	Fort Wayne	1995	No additional information provided.
5	IN	Lawrence STP	09/30/02	The Order addressed permit violations.
5	IN	Town of West College Corner	03/22/02	The Order required that the City submit certain information to EPA stating: the current status of compliance for each item on the IDEM approved action plan and the costs associated with each activity, and the needed plant improvements to come into consistent compliance with the NPDES permit, including proposed time to construct and the costs of construction.
5	IN	Town of West College Corner	12/08/97	The Order required that the Town will submit a Compliance Plan (CP) to the Indiana Department of Environmental Management (IDEM) for approval within 30 days.
5	OH	City of Fostoria	09/27/01	The Order required the City to submit a detailed Plan of Action containing a fixed date schedule describing actions taken, or, to be taken, to eliminate Outfall 009E which are not in accordance with the NPDES permit.
5	OH	City of Willoughby Hills	09/26/01	The order required the City to eliminate the discharge of raw or partially treated sewage within 20 days. The City plans to install sanitary sewers in the Oak Street area to alleviate the failing septic system.
5	OH	Lake County	09/26/01	The Order required the County to eliminate the discharges of raw or partially treated source within 20 days.
5	OH	Licking County Buckeye Lake Sewer District No. 1 WWTP	02/05/97	The order required the preparation of a detailed plan of action to eliminate SSOs.
5	OH	Village of College Corner	03/22/02	The Order required that the City submit certain information to EPA.
5	WI	City of South Milwaukee	03/19/01	The Order required that by 11/30/01, the City will eliminate the sanitary flow restrictive junction at 15th Avenue and Manitowac Avenue, install manhole liners in 1,000 manholes and upgrade the Lake Drive Lift Station.
6	AK	City of Hot Springs	06/02/00	Within one month of this Order, the City will submit a comprehensive plan for the expeditious elimination and prevention of unauthorized discharges and overflows of wastewater from its collection system. The plan will provide specific actions to be taken and include a schedule for achieving compliance.

Region	State	Case Name/City Name	Effective Date	Description
6	LA	City of Opelousas	06/06/02	The Order required that the City provide a comprehensive construction progress summary to EPA for Phase I and Phase II rehabilitation activities within one month
6	LA	City of Opelousas	04/30/99	This Order required that all projects for the Phase I, Collection System Rehabilitation will be complete by 08/31/99. The Order also required that all projects for the Phase II, Collection System Rehabilitation will be complete by 09/31/01 and that all projects for the Phase III, Collection System Rehabilitation will be complete by 07/31/02.
6	LA	City of Rayne	2002	The Order required that the City take whatever corrective action is possible to eliminate and prevent recurrence of the violations within one month. If one month is not possible, then the City will submit an action plan detailing how the City intends to eliminate overflows in the collection system in the shortest amount of time possible. This plan will include a schedule for eliminating overflows in the collection system.
6	LA	City of Shreveport	07/29/97	The Order required that the City take whatever corrective action is possible to eliminate and prevent recurrence of the violations within one month. If one month is not possible, then the City will submit an action plan detailing how the City intends to eliminate overflows in the collection system in the shortest amount of time possible. This plan will include a schedule for eliminating overflows in the collection system.
6	LA	City/Parish of East Baton Rouge	09/09/94	This Order was issued requiring the City to report past SSOs from its collection system and to continue reporting those SSOs in tabular form along with its monthly Discharge Monitoring Report (DMRs).
6	LA	City/Parish of East Baton Rouge	01/30/98	The Order required that the City take whatever corrective action is possible to eliminate and prevent recurrence of the violations within one month. If one month is not possible, then the City will submit an action plan detailing how the City intends to eliminate overflows in the collection system in the shortest amount of time possible. This plan will include a schedule for eliminating overflows in the collection system.
6	NM	City of Carlsbad	08/29/00	The Order required that the City take whatever corrective action is possible to eliminate and prevent recurrence of the violations within one month. If one month is not possible, then the City will submit an action plan detailing how the City intends to eliminate overflows in the collection system in the shortest amount of time possible. This plan will include a schedule for eliminating overflows in the collection system.
6	TX	City of Austin	06/10/99	A penalty of \$27,500 was assessed based on, among other things, the number of violations the City committed.
6	TX	City of Austin	10/25/99	The civil penalty of \$21,000 listed in this Order settles all violations.
6	TX	City of Austin	04/29/99	The Order required that the City perform numerous pump station upgrades, carry out infiltration and inflow (I/I) and SSES studies, and implement remedial actions. The Order required that compliance be achieved by 12/31/07.

Region	State	Case Name/City Name	Effective Date	Description
6	TX	City of Austin	09/11/98	The Order required that the City take whatever corrective action was possible to eliminate and prevent recurrence of the SSOs within one month. If one month was not possible, then the City was to submit an action plan detailing how the City intended to eliminate overflows in the collection system in the shortest amount of time possible. This plan will include a schedule for eliminating overflows in the collection system.
6	TX	City of Dallas	10/25/00	Within one month of this Order, the City will take whatever corrective action is possible to eliminate and prevent recurrence of the violations. If one month is not possible, then the City will submit an action plan detailing how the City intends to eliminate overflows in the collection system in the shortest amount of time possible. This plan will include a schedule for eliminating overflows in the collection system. A \$27,500 penalty was assessed.
6	TX	City of Dallas	08/08/00	This Order was issued requiring the City to take corrective action to prevent a discharge to occur again and set up a meeting with EPA.
6	TX	City of Denton	07/26/02	The City will complete construction of Pecan Creek WWTP improvements by 01/04. The City will complete construction of Cooper Creek Lift Station Improvements and the Pecan Creek Interceptor Phase I by 06/04. The City will complete construction of Pecan Creek Interceptor Phase II by 10/05.
6	TX	City of Denton	09/19/02	A \$137,500 penalty was assessed.
6	TX	City of Denton	06/30/99	EPA provided the City with a list of scheduled activities. The City will follow the schedule so that the violations due to overflows/unauthorized discharges from the collection system of the POTW will be corrected.
6	TX	City of Denton	01/14/99	The Order required that the City take whatever corrective action is possible to eliminate and prevent recurrence of the violations within one month. If one month is not possible, then the City will submit an action plan detailing how the City intends to eliminate overflows in the collection system in the shortest amount of time possible. This plan will include a schedule for eliminating overflows in the collection system.
6	TX	City of Galveston	05/18/01	This Order modified the schedule for construction improvements. Complete the Lift Station Improvements and the Trunk Sewer Improvements (trunk sewers without adequate capacity) by 12/31/01. Complete the Trunk Sewer Improvements (to prevent overflows under surcharge conditions) by 12/31/02. All overflows and bypasses of the collection system will be eliminated by 01/31/03.
6	TX	City of Galveston	12/18/00	A \$14,850 penalty was assessed.
6	TX	City of Galveston	07/26/99	The Order modified the schedule for construction improvements. It required the completion of the Lift Station Number One Upgrade by 03/31/00. It required the completion of the Trunk Sewer Improvements (trunk sewers without adequate capacity and Lift Station Improvements) by 12/31/01. All overflows and bypasses of the collection system must be eliminated by 01/01/02.

Region	State	Case Name/City Name	Effective Date	Description
6	TX	City of Galveston	12/09/96	This Order required that the City complete the Port Industrial Main improvements, the 10th Street Trunk replacement/Jones Drive replacement, manhole rehabilitation and structural repairs, and trunk sewer improvements. All improvements were to be complete by 06/30/01.
6	TX	City of Galveston	10/07/96	This Order incorporated a compliance schedule, submitted by the City, for the elimination of wet weather and dry weather overflows throughout the collection system.
6	TX	City of Humble	1998	The Order required that the City take whatever corrective action is possible to eliminate and prevent recurrence of the violations within one month. If one month is not possible, then the City will submit an action plan detailing how the City intends to eliminate overflows in the collection system in the shortest amount of time possible. This plan will include a schedule for eliminating overflows in the collection system.
6	TX	City of Jacksonville	02/22/99	The Order required that the City complete the rehabilitation of the western portion of the collection system by 06/01/99, complete the Sewer System Improvements, Line B4 by 11/01/00, complete the Sewer System Improvements, Line B2 by 04/01/02, and complete more specified improvements on an annual basis.
6	TX	City of Jacksonville	10/22/97	The Order required that by 08/31/98, the City submit to EPA a construction schedule for all improvements necessary to eliminate overflows from their collection system.
6	TX	City of Nederland	05/30/97	The Order required that the City will complete a SSES and submit a schedule for the rehabilitation of all system defects not completed during the SSES by 07/98.
6	TX	City of Nederland	09/16/96	This Order was issued for overflows from the sewer system.
6	TX	City of Nederland	01/31/95	This Order was issued requiring, among other things, that the City submit a plan and schedule for mitigating of the effects of the I/I on the system and the immediate elimination of the bypass located on Avenue C.
6	TX	City of South Houston	09/17/98	Within one month of this Order, the City will take whatever corrective action is possible to eliminate and prevent recurrence of the violations. If one month is not possible, then the City will submit an action plan detailing how the City intends to eliminate overflows in the collection system in the shortest amount of time possible. This plan will include a schedule for eliminating overflows in the collection system.
6	TX	City of South Houston	06/25/96	The Order required that the City take whatever corrective action is possible to eliminate and prevent recurrence of the violations within one month. If one month is not possible, then the City will submit an action plan detailing how the City intends to eliminate overflows in the collection system in the shortest amount of time possible. This plan will include a schedule for eliminating overflows in the collection system.
6	TX	City of South Houston	01/23/96	This Order was issued requiring compliance with a schedule for Activity Numbers One thru Four in the Industrial User Survey submittals.
6	TX	San Antonio Water System	07/11/96	The Order required that the System perform an I/I study of their collection system to include flow monitoring. A submission of schedules for rehabilitation was required when the studies were complete.

Region	State	Case Name/City Name	Effective Date	Description
6	TX	San Antonio Water System	04/14/94	The Order contained a schedule for the installation of permanent flow meters and a study of the collection system. The schedule was modified 04/11/96.
7	MO	City of Campbell	04/04/01	Action taken to eliminate SSOs.
7	MO	City of Platte City	05/22/02	A \$60,000 penalty was assessed.
7	MO	City of Platte City	12/10/02	The City will immediately pay a \$15,000 penalty. Upon satisfactory completion of multiple SEPs projects, the remaining \$45,000 of the total (\$60,000) will be suspended. The SEPs were intended to serve as significant environmental or public health protection and improvement.
10	AK	City and Borough of Juneau, Alaska, Mendenhall Wastewater Treatment Facility	09/11/00	The Order required that a written plan for the elimination of unauthorized discharges be submitted to EPA within one month. The plan must include provisions for a thorough study of the collection system, a plan for addressing the problems identified and a schedule of completion for activities
10	WA	Lummi Indian Business Council of the Lummi Nation, WA	07/29/02	The Order required that the Council perform various wastewater treatment plant upgrades and to investigate and seek available funding mechanisms for the Lummi Shore collection system upgrade by 12/31/02.

K.5 Federal CSO Administrative Penalty Orders

Region	State	Case Name/City Name	Effective Date	Penalty Amount
1	MA	City of Fitchburg	02/02/96; Amended 07/02/96	\$208,800
1	MA	Town of Palmer	01/06/97	\$5,000

K.6 Federal SSO Administrative Penalty Orders

Region	State	Case Name/City Name	Effective Date	Penalty Amount
2	Puerto Rico	PRASA Puente Blanco Pump Station & Collection System	12/23/02	\$27,500
3	PA	Monaca Borough	05/20/99	\$18,000
5	IN	Town of West College Corner	12/08/97	\$24,062
6	TX	City of Austin	10/25/99	\$21,000
6	TX	City of Austin	06/10/99	\$27,500
6	TX	City of Dallas	10/25/00	\$27,500
6	TX	City of Denton	09/19/02	\$137,500
6	TX	City of Galveston	12/18/00	\$14,850
7	MO	City of Campbell	04/04/01	\$87,500
7	MO	City of Platte City	05/22/02	\$60,000
10	AK	City and Borough of Juneau, Mendenhall Wastewater Treatment Facility	09/11/00	\$60,000
10	AK	City and Borough of Juneau, Mendenhall Wastewater Treatment Facility	08/15/01	\$30,000

K.7 State CSO Judicial Orders

Region	State	Case Name/City Name	Effective Date	Description
1	ME	City of Bangor and State of Maine	Entered 06/30/87; Amended 12/01/87	This Order addressed NPDES permit violations. The City was required to pay a \$40,000 civil penalty which provide other relief for certain violations of the NPDES permit requirements.
1	ME	City of Bangor and State of Maine	04/09/91	The City completed a short-term sewer rehabilitation project for a previous State Consent Order and has begun long-term sewer rehabilitation and Combined Sewer Overflow (CSO) abatement projects.
2	NJ	Borough of East Newark	02/11/99	The Order required that within 12 months of East Newark's receipt of the Department's Stage II/III TWA, the Borough will complete the required construction and commence operation of the approved treatment works.
2	NJ	Borough of Fort Lee	08/16/95	The Order addressed failure to meet the discharge of solids/floatable requirements established in the 1995 Administrative Consent Order.
2	NJ	City of Bayonne	08/24/00	This was a settlement between both parties stating that both parties had voluntarily agreed to a settlement and that the agreement fully disposed of all issues in controversy and was consistent with the law.
2	NJ	City of Bayonne	08/01/00	The Order required that construction of the Group One CSO Points 006 and 015 will be complete by 07/22/99. Within 15 months from the Department's issuance of the Stage II/III Treatment of Works Approval (TWA) for the Group I CSO points, construction will be complete and the Solids/Floatables control measures will be implemented. Within 15 months of Bayonne's receipt of the Department's Stage II/III TWA, the Group Two CSO Points required construction will be complete.
2	NJ	City of Kearny	02/11/99	The Order required that within 12 months of the City's receipt of the Department's Stage II/III TWA, the City will complete the required construction and commence operation of the approved treatment works. By 01/31/00, the City will complete construction for the Storm Sewer System 1A (Sewer Separation Project).
2	NJ	City of Paterson	05/22/02	The Order required the City to complete construction of Romag CSO Points 30 and 31 by 06/01/05. The City will complete construction of Romag CSO Point 16 by 06/01/04. The City will complete construction of Romag CSO Points 25, 27, and 29 by 12/01/07. The City will complete construction of the sewer separation by 12/31/04.
2	NJ	Village of Ridgefield Park	08/20/99	The Order required, among other things, construction of the approved Long-term Solids/ Floatables Control Measures will be complete within nine months of receipt of Department's Stage II/III approval. Construction will be complete for the Solids/Floatables Control Facilities at outfall 001 and outfall 002 by 01/17/00, at outfall 003 by 11/30/99, at outfall 005 by 12/01/99, and at outfall 006 by 11/09/99.
2	NJ	Village of Ridgefield Park	07/22/98	The Order addressed permit violations.

Region	State	Case Name/City Name	Effective Date	Description
2	NY	Onondaga County Department of Drainage and Sanitation and, Onondaga County	01/20/98	The County was required to design, test, and construct modifications and additions to the Metro facility, including diversion of the Metro's effluent to the Seneca River. By 11/01/03, the County will complete construction of the Full Scale Ammonia Removal Project. By 04/01/05, the County will complete construction of the Phosphorus Removal/ Effluent Filtration Project. By 06/01/02, the County will complete construction and commence full operations of all projects to achieve Stage III effluent limits, or achieve revised effluent limits.
2	NY	Onondaga County Department of Drainage and Sanitation and, Onondaga County	02/01/89	The County was obligated to develop a Municipal Compliance Plan that would bring the County's effluent discharges from the Metro facility and the CSOs into compliance with the State's effluent limitations and water quality standards, and then implement such a plan.
3	MD	Frostburg (The Mayor and Town Council of)	12/14/01	Immediately following the Department's approval of its LTCP, Frostburg will begin implementation of the LTCP and then complete implementation of the LTCP in accordance with the approved schedule.
3	MD	The City of Cambridge (The Mayor and Commissioners of)	02/05/99	This Order stated that within 11 months of the notice to proceed construction, the City will complete construction of the interceptor work along Water Street and complete separation of the combined sewer and storm water lines along Mill Street and Vue de L'eau Street. Within seven months of the respective notice to proceed with construction of the Phases II, III, IV, V, and VI improvements, complete construction of Phases II, III, IV, V, and VI improvements.
3	MD	The City of Cambridge (The Mayor and Commissioners of)	11/23/93	The Order required the City to improve the Cambridge Wastewater Treatment Plant and the sewer system. The City will also submit a study, plan and schedule for improvements to the sewer system design to alleviate wastewater discharges into any and all streets.
3	MD	Westernport (The Mayor and Town Council of)	08/23/02	Within one month after this Consent Decree, Westernport will implement all elements of the Nine Minimum Controls (NMCs). Within one month following the Department's approval of its Long-Term Control Plan (LTCP) and schedule, Westernport will implement its LTCP.

K.8 State SSO Judicial Orders

Region	State	Case Name/City Name	Effective Date	Description
2	NJ	Rahway Valley Sewerage Authority (RVSA)	07/09/01	Within 31 months of this Order, RVSA will complete construction of the Final Effluent Polishing Facilities, Disinfection Facilities, Pumping Facilities, Sampling Chambers, and Auxiliary Power. Within 31 months of completion of Phase I, Phase II construction will be complete.
3	VA	District of Columbia, Fairfax	01/25/02	In this Order, the District agreed to pay the Commonwealth \$325,000 in settlement of violations and close the Lorton facility.
3	WV	Crab Orchard/ MacArthur Public Service District	02/04/00	This Consent Decree was issued for failure to comply with State water quality standards and effluent limitations for discharging pollutants into the Piney Creek and other waters of the State, for violating their NPDES Permit, and for failure to comply with several orders.
3	WV	St. Albans Municipal Utility Commission, City of St. Albans	10/13/98	This Consent Decree was issued for failure to comply with state water quality standards and effluent limitations for discharging pollutants into the Kanawha River and other waters of the State, for violating their NPDES Permit, and for failure to comply with several orders.
4	AL	The City of Brent, Brent Water and Sewer Board, City of Centreville, and the Centreville Waterworks and Sewer Board	01/30/02	Within 12 months of this Order, they will repair Pump Stations Numbers One, Two, Three, Four, and Five in the Centreville and Brent collection system.
4	AL	The Water Works and Sewer Board of the City of Prichard	01/30/97	Within 420 days of this Order, the construction of the Gumtree Branch replacement sewer line or any other cost-effective remedy approved by Alabama Department of Environmental Management will be complete. Within 1,230 days of this Order, the construction of the new side stream storage facility will be complete.

K.9 State CSO Administrative Orders

Region	State	Case Name/City Name	Effective Date	Description
1	ME	City of Bath	01/09/92	Before 06/01/93, the City will submit to the Department for review and approval a master plan for abatement of Combined Sewer Overflows (CSOs) from its sewerage system, including a schedule. The City will also develop a long-term Pump Stations Facility Plan, including a schedule. By 07/01/92, develop a Comprehensive Treatment Plant Facilities Plan to address the current and future needs of the City to achieve state of the art wastewater treatment consistent with its discharge license limitations.
1	ME	City of Biddeford	07/22/91	The Order required, among other things, that by 01/01/93, they will complete sewer system improvement projects in order to eliminate or abate CSO discharges. Beginning in 01/92, the City will complete all other CSO abatement projects described in the approved interim and final Sewer System Master Plan.
1	ME	City of Brewer and Eastern Fine Paper Company	02/27/92	The Order required a CSO Master Plan will be submitted to the Department before 06/01/93. This master plan will include a schedule for implementation and construction of all projects.
1	ME	City of Westbrook, Portland Water District, Westbrook	10/21/91	The Order required that by 12/91, Westbrook and Portland Water District will complete all projects listed and described in the Final Sewer System Master Plan.
1	ME	The City of Portland and Portland Water District	02/13/91	The Order required that by 12/93, Portland and Portland Water District will complete sewer system improvement projects in order to eliminate or abate CSO discharges.
1	ME	Town of Bucksport	03/01/90	The Order required that by 02/01/90, the Town will submit to the Department for review and approval, plans and a schedule for the installation of chlorination/dechlorination facilities. By 02/15/90, the Town will submit to the Department for review and approval a plan monitoring CSOs from its sewage system.
1	ME	Town of Lisbon	05/24/90	The Order required that by 05/01/90, the Town will submit to the Department for review and approval, a process control plan to specifically deal with filamentous bulking. The Town will also submit to the Department for review and approval, a pump station and sewer maintenance program, including a time schedule for implementation of this pump station and sewer maintenance plan.
1	ME	Town of Lisbon	04/13/88	The Order addressed upgrading the Town's secondary wastewater treatment facilities.

Region	State	Case Name/City Name	Effective Date	Description
2	NJ	Borough of Fort Lee	06/01/95	The Order required that within 15 months of the Borough's receipt of the New Jersey Department of Environmental Protection's (NJDEP's) Stage II/III approval, the Borough will complete construction and commence operation of the approved Long-term Solids/Floatables Control Measures.
2	NJ	Camden County Municipal Utilities Authority	02/27/98	The Order addressed, among other things, permit violations.
2	NJ	Camden County Municipal Utilities Authority	03/31/97	The Order addressed, among other things, permit violations.
2	NJ	City of Camden	08/23/99	The City was required to fully implement the O&M Program and develop and implement the CSO Pollution Prevention Plan by 09/30/99.
2	NJ	City of Camden	03/31/97	The Order addressed, among other things, permit violations.
2	NJ	City of Gloucester	07/22/99	The Order addressed, among other things, permit violations. The City was supposed to plan, design, improve, operate and maintain its combined sewer system (CSS) as required and set forth by its permit.
2	NJ	City of Gloucester	03/31/97; Amended 06/30/98	The Order addressed, among other things, permit violations.
2	NJ	City of New Brunswick	04/25/94	The Order required that within six months from the start of construction for the backflow prevention device, the construction will be complete. Additionally, the City was required to submit a time table for attaining the completion of the sewer separation project by 12/01/94.
2	NJ	City of Newark	05/21/01	Under this Order, the City was required to complete construction and commence operation of the Long-Term Solids/ Floatable Control Plan for all its CSO points within 15 months of the City's receipt of the Department's Treatment of Works Approval (TWA).
2	NJ	City of Newark	12/07/98	The Order addressed the City's noncompliance with its permit.
2	NJ	City of Paterson	02/01/99	The Order addressed permit violations.
2	NJ	City of Perth Amboy	07/26/95	The City was required to complete construction and eliminate the illegal discharges from the homes located on High and Hartford Streets at the corner of Buckingham Avenue, complete construction for the Budapest sewer separation project, eliminate the raw sanitary waste water discharge from DSN 001, and permanently close the seal at DSN 001. The City was also required to complete the upgrades/ repairs to the State Street, Front Street, and Amboy Avenue pump stations within 12 months of beginning construction and complete the repair of the CSO pipes at DSN 002 and DSN 017 within six months.

Region	State	Case Name/City Name	Effective Date	Description
2	NJ	City of Perth Amboy	09/30/93	The City was required to complete construction and implementation of a project that is used to control the discharge of solids/ floatables and properly dispose of solids/ floatables by 03/01/97.
2	NJ	City of Rahway	05/08/00	This Order required the City to complete construction necessary to remove the identified sources of inflow contributing to outfalls 001, 004 and 005 by 11/01/03. Additionally, the City was required to complete construction necessary for the separation of the combined sewer tributary to outfalls 003 and 004 by 03/01/03. The City was required to complete construction necessary to remove the identified sources of inflow contributing to outfalls 002 and 003 by 05/01/04. The City was also required to complete construction necessary for the separation of the combined sewer tributary to outfall 002 by 03/01/04.
2	NJ	Edgewater Municipal Utilities Authority	09/30/93	The Order required the City to complete construction and implement measures to control the discharge of solids/ floatables and properly dispose of these solids/floatables by 03/01/97.
2	NJ	Hoboken/Union City/Weehawken Sewerage Authority (HUCWSA)	09/30/93	Under this Order, HUCWSA will complete construction and implementation of a project that is used to control the discharge of solids/ floatables and properly dispose of solids/ floatables by 07/01/97.
2	NJ	Middlesex County Utilities Authority	04/13/95	This Order addressed violations of the Water Pollution Control Act (WPCA), implementing regulations, and its permit.
2	NJ	Middlesex County Utilities Authority (MCUA)	06/05/96	The Order required MCUA to complete the upgrade of the worse 20 metering chambers to accurately measure all flows, including peak flows during storm events by 10/01/97. MCUA was also required to complete the upgrade of all of the remaining metering chambers to accurately measure all flows, including peak flows during storm events by 04/01/98, .
2	NJ	Rahway Valley Sewerage Authority (RVSA)	09/30/93	RVSA was required to complete construction and implementation of a project that is used to control the discharge of solids/ floatables and properly dispose of solids/ floatables by 03/01/97.
2	NJ	Town of Guttenberg	09/30/93	This Order addressed the failure to comply with its permit, the WPCA, and the SIIA.
2	NJ	Town of North Bergen Municipal Utilities Authority (NBMUA), Town of Guttenberg/ Woodcliff Sewage Treatment Plant	12/13/95	This Order required NBMUA to complete construction and commence operation of the control measures in the Interim Solids/ Floatables Control plan within 12 months of the NBMUA's receipt of NJDEP's Stage II/III approval. Also, NBMUA will complete construction and commence operation of the Long-Term Solids/ Floatables Control measures within 15 months of receipt of NJDEP's Stage II/III approval.
2	NJ	Town of North Bergen Municipal Utilities Authority (NBMUA), Town of Guttenberg/ Woodcliff Sewage Treatment Plant	09/30/93	This Order addressed the failure to comply with its permit, the WPCA, and the Sewage Infrastructure Improvement Act (SIIA).

Region	State	Case Name/City Name	Effective Date	Description
2	NJ	West New York Municipal Utilities Authority (WNYMUA)	09/30/93	Under this Order, WNYMUA will develop and implement technology-based control measures to address the minimum technology-based limitations by 10/01/95. Additionally, WNYMUA will complete construction/ implementation of the Long-Term Solids/ Floatables Control Measure Strategy by 03/01/97.
2	NY	New York City, Department of Environmental Protection (NYDEP)	06/26/92	The Order required the NYDEP to establish an environmental benefit program, costing \$250,000; continue its CSO abatement program, including the Track One CSO Abatement (DO and Coliform) and the Track Two CSO Abatement (Floatables); and supplement the data collection gathered as part of the NY/NJ Harbor Estuary Program and gather additional information concerning the contribution of heavy metals to the Harbor from CSOs.
2	NY	New York City, Department of Environmental Protection (NYDEP)	Modification 03/96	In addition to the CSO Abatement Program required by the 1992 Order, this modification required the NYDEP to add another program which consisted of the inspection, inventory, mapping, replacement of missing hoods, and cleaning to facilitate inspection and hood replacement of those catch basins located in Phases I & II areas identified in this Order. They were required to retain a consulting firm to perform the inspections of each of the catch basins identified. Additionally, they were required to submit a scope of work to determine an appropriate and cost-effective catch basin cleaning program for floatables capture and flood control in specific locations throughout the City.
3	DE	City of Wilmington	02/06/03	The Order required the City to modify the significant industrial users (SIUs) permits, determine whether any dry weather flow from a CSO is an overflow or infiltration, and notify the citizens of when and where CSOs occur.
3	MD	Mayor and City Council of Frostburg	12/30/96	This Order was issued requiring them to implement a CSO Control Program or a plan to enable it to comply with the EPA CSO Control Policy, including NMCs by 07/01/97.
4	TN	Metropolitan Government of Nashville and Davidson County	09/17/99	The City and County was required to have all CSO controls, including but not limited to, floatable material and debris removal, combined sewage storage and/or detention and CSO elimination, in place by 07/01/01. The City and County will eliminate all overflows or bypassing from its sanitary sewers to all waters of the state by 07/01/01. Of the total \$600,000 penalty, \$100,000 will be due within one month of this Order. However, in lieu of the \$100,000, a SEP may be performed by the City and the County.
5	IN	City of Bluffton	06/24/03	This Order required the City to immediately implement the approved LTCP and adhere to the milestone dates.
5	IN	City of Boonville	11/25/02	This Order required the City to immediately implement the approved LTCP and adhere to the milestone dates.
5	IN	City of New Castle	01/27/03	This Order required the City to immediately implement the approved LTCP and adhere to the milestone dates.
5	IN	City of Sullivan	01/22/03	This Order required the City to immediately implement the approved LTCP and adhere to the milestone dates. Also, the City was required to submit to IDEM a Compliance Plan, including a construction schedule by 03/01/03.

Region	State	Case Name/City Name	Effective Date	Description
5	IN	Town of Centerville	11/25/02	This Order required the Town to submit to Indiana Department of Environmental Management (IDEM) the CSO Operational Plan and the Stream Reach Characterization Evaluation Report as soon as possible but no later than 06/01/03, and complete the LTCP.
5	IN	Town of Remington	06/06/03	The Order required the Town to complete construction, cease overflows from Outfall 004, and provide IDEM a certification statement of completion of construction within nine months of this Order.
5	IN	Town of Ridgeville	09/11/02	This Order required the City to immediately implement the approved LTCP and adhere to the milestone dates.
5	IN	Town of Ridgeville	10/15/01	This Order required the Town to submit to the IDEM its complete Stream Reach Characterization and Evaluation Report by 09/30/01 and submit its LTCP for approval by 03/15/02.
5	IN	Town of Summitville	01/29/03	This Order required the City to immediately implement the approved LTCP and adhere to the milestone dates.
7	MO	City of Macon, MO	05/29/01	This Order required that a schedule for the Nine Minimum Controls (NMCs) be submitted by 06/01/01. Upon review and approval of the LTCP and the schedule for implementation of the LTCP, the City will complete each phase of the LTCP in accordance with the approved schedule.
7	MO	City of Sedalia, MO	06/15/92; Amended 02/10/03	This Order required the City to complete construction of Phase I by 12/01/04, complete construction of Phase II by 12/01/05, and complete construction of Phase III by 09/15/07.
10	OR	City of Astoria	01/07/93	The City has completed the studies and planning activities required by the Order, and on 09/30/98, submitted a CSO Facilities Plan to the Department.
10	OR	City of Astoria	08/05/02	This Order required the City to eliminate all untreated CSO discharges within 15 months of Department approval of the Plans and Specifications.
10	OR	City of Corvallis	11/09/92	Under this Order the City was required to eliminate discharges that violate applicable water quality standards, subject to storm return frequencies at five CSO discharge points by 12/31/01.
10	OR	City of Portland	08/11/94	Under this Order, the City was required to eliminate untreated CSO discharges at 20 of the CSO discharge points, including discharges to Columbia Slough by 12/01/01, eliminate untreated CSO discharges at 16 of the remaining discharge points by 12/01/06, and eliminate untreated CSO discharges at all remaining CSO discharge points by 12/01/11.
10	OR	City of Portland	08/05/91	Under this Order, they were required to carry out necessary studies and corrective actions to eliminate the discharge of untreated overflows from the combined sewer system, up to one in ten year summer storm event and up to a one in five year winter storm event. The City was required to submit scope of study for the facilities plan and for an interim control measures study.
10	WA	City Of Spokane	12/13/99	This Order addressed untreated sewage discharging from the City's CSO outlet #15. A penalty of \$15,000 was eventually assessed for the violation.

K.10 State SSO Administrative Orders

Region	State	Case Name/City Name	Effective Date	Description
1	NJ	Bergen County Utilities Authority Sewage Treatment, Bergen County	12/17/91; Amended 05/20/97; Amended 02/01/99	This Order required Bergen County Utilities Authority to complete the Municipal Sewer Operations and Maintenance Program and submit a final report to the Department by 10/01/05.
1	NJ	Cliffside Park Borough, Bergen County	06/22/01	This Order required the Borough to plan, design, construct, operate, and/or implement modifications to the collection and conveyance facilities that will result in the elimination of major storm water contributions to the CSOs from Sanitary Sewer Outlet Plan, Regulator Ten. Construction was required to be completed by 06/01/02.
2	NJ	Borough of Flemington	10/20/99	The Borough was required to immediately cease all unpermitted discharges of pollutants emanating from its wastewater collection system.
2	NJ	Borough of Flemington	04/08/03	This Order addressed permit violations.
2	NJ	City of Summit	05/28/99	The City was required to immediately cease all unpermitted discharges from the System and seal the overflow point from the Chatham Road Pump Station holding tank.
2	NJ	City of Summit	07/23/02	This Order required the city to submit a comprehensive upgrade plan with a time schedule by 08/01/02; within 12 months of issuance of the Treatment Of Works Approval (TWA), the City was to complete construction and installation and commence operation of the additional pump(s).
2	NJ	Englewood Cliffs Borough	05/15/97	This Order required the Borough to complete construction of Category 1A by 04/01/02, and complete construction of Category 1B by 04/01/09.
2	NJ	Ewing-Lawrence Sewerage Authority, Trenton	09/14/00	Under this Order, Ewing-Lawrence Sewerage Authority was required to complete private property I/I corrective action for all properties which discharge into the sewage collection system upstream of Jacobs Creek Diversion Chamber by 07/01/02.
2	NJ	West Milford Township Municipal Utilities Authority	03/28/00	This Order required the Authority to complete construction of the recommendations of the Phase I Report by 10/16/02.
2	NY	City of Oneida	01/04/01	This Order required the City to submit for review an approvable composite correction program with a proposed schedule of work within two months of this Order, after Department approval of the comprehensive performance evaluation final report.
2	NY	City of Sherrill	04/09/90	This Order required the City to submit to the Department for approval a plan and implementation schedule for bringing the City into compliance with its flow limits of its State Pollutant Discharge Elimination System (SPDES) permit within nine months of this Order.
2	NY	County of Westchester	08/17/98	The County was required to complete all repairs to the Public I/I by 12/31/02, and complete construction of the SSO Treatment Facilities for New Rochell S.D. Outfalls 003 and 005 by 04/01/04.

Region	State	Case Name/City Name	Effective Date	Description
2	NY	Mount Vernon Sewer District, Hamburg	10/22/01	This Order required the District to submit an engineering report for abatement of all SSOs, including an approvable schedule, within six months of this Order.
2	NY	Town of Coeymans	05/04/01	The Order required the Town to submit to the Department for approval an I/I reduction plan to address excessive I/I within the Town. They were also required to submit to the Department for approval a detailed Wet Weather Operations Plan to minimize the discharge of pollutants during wet weather and to prevent/minimize upset conditions.
2	NY	Town of East Greenbush	11/08/00	This Order required the Town to submit to the Department for approval an I/I investigation plan by 01/15/01.
2	NY	Town of Greenport	06/06/01	This Order required the Town to submit to the Department for approval an I/I remedial plan and expeditious schedule by 08/01/02.
2	NY	Town of North Greenbush	11/27/00	This Order required that by 10/15/00, the Town would submit to the Department for approval an I/I removal plan that will result in the elimination of excessive I/I within the sewer system.
2	NY	Town of North Greenbush Modified	10/2/01	The Order required the Town to submit to the Department for approval an I/I remedial plan which was to include the results of the I/I investigation by 01/01/02.
2	NY	Town of Owasco	06/11/01	This Order required the Town to complete construction of Contract Number One by 10/26/01, as well as complete construction of Contract Number Two and eliminate existing sewer overflows by 02/28/02.
2	NY	Town of Sand Lake	07/21/00	This Order required the Town to submit to the Department for approval an I/I investigation plan which will include a schedule for implementation by 08/15/00.
2	NY	Town of Tonawanda	01/02/87; Revised 03/22/95	The Town was required to install 4,400 new sump pumps and correct 1,650 existing sump pumps and 6,600 downspouts by 12/31/05.
2	NY	Town of Tonawanda	07/05/95	The Town was required to submit to the Department for approval a City Sanitary and Storm Sewer Management Plan by 09/01/95, and eliminate 322 of the 446 cost effective private sources of inflow identified in the City by 06/30/95.
2	NY	Town of Tonawanda	02/87	This Order required the Town to submit a report detailing cost-effective work which would minimize raw sewage overflows to surface waters and the complete the required work established in the schedule of this Order.
2	NY	Village of Attica	09/18/97	This Order required the Village to submit certification from a professional engineer that the inflow removal Compliance Actions would be completed according to the Schedule of Compliance outlined in the permit by 11/01/97. The Order also required them to submit a Plan of Study prepared by a professional engineer to identify and remove all sources of excessive infiltration in the Village's sanitary sewer collection system by 12/01/97.

Region	State	Case Name/City Name	Effective Date	Description
2	NY	Village of Cobleskill	07/22/98	This Order required that within 12 months of this Order, construction of Phase I would be complete, within 24 months of this Order, construction of Phase II would be complete, within 36 months of this Order, construction of Phase III would be complete, and Phase IV would be complete within 48 months of this Order if Phases I-III do not adequately address I/I.
2	NY	Village of Cobleskill	Modified 05/31/01	This Order required that by 12/31/01, the design and construction of walls and additional piping in the aeration tanks would be complete and by 06/15/01, bypasses to the wastewater treatment facility would be eliminated. Additionally, construction of Phase I was required to be complete within six months of this Order and construction of Phase II would be complete within 24 months of this Order.
2	NY	Village of Endicott	02/01/90	This Order required the Village to submit to the Department a plan to locate, install, and monitor newly installed wells by 03/15/90. The Village was also required to submit to the Department for approval, a Scope of Services report by 02/15/90 and within the appropriate time frame, complete the Phase I and Phase II of the I/I investigation.
2	NY	Village of Fort Ann	08/07/01	This Order addressed permit violations and assessed a \$17,000 penalty. Within 12 months of construction start, all corrective measures were supposed to be complete.
2	NY	Village of Hancock	01/31/02	This Order required the Village to have the valves located upstream of the Brooklyn and Pennsylvania Avenue pump stations be permanently closed by 06/01/02.
2	NY	Village of Kenmore	01/28/87; Modified 06/09/95	This Order required the Village to install sump pumps, if necessary, by 05/01/89.
2	NY	Village of Saranac Lake	10/03/00	The City was required to implement all improvements to manhole number ten by 11/30/00. The City will submit an approvable plan for continuous ongoing sewer system assessment, flow monitoring, correction and maintenance, including a schedule for each, by 02/28/01.
2	NY	Village of Schuylerville	04/04/01	The Village was required to submit to the Department, within 14 months after completion of "the project," an engineering report that evaluates the effectiveness of sump pump removal and replacement of sanitary sewers and manholes at reducing I/I.
2	NY	Village of Stamford	01/24/00	The Order required the Village to begin the I/I remedial work and complete all work by 06/30/02.
2	NY	Village of Stamford	Modified 06/05/00	This Order required that by 06/30/00, the Village would submit to the Department for approval an I/I investigation plan.

Region	State	Case Name/City Name	Effective Date	Description
2	NY	Village of Williamsville	04/13/98	This Order required the Village to submit to the Department for approval a plan for continuous ongoing sewer system assessment, flow monitoring, correction and maintenance, including a compliance schedule by 09/01/97, as well as an engineering report for abatement of discharges from sanitary sewer outfalls 001 thru 008 by 09/01/98.
3	VA	Caroline County Regional WWTP, Caroline County	04/01/02	This Order addressed violations of its permit for an unpermitted discharge, failure to take reasonable steps to minimize or prevent any discharge which has a likelihood of adversely affecting human health or the environment, and failure to properly operate and maintain systems. The County was required to develop and implement written procedures for identification of potential collection system problems; review and evaluate operation and maintenance staffing; update all O&M manuals for the pumping stations and the WWTP; and develop and implement an inspection program.
3	VA	Commander, Navy Region, Mid-Atlantic (Regional Engineer)		This Order resolved certain violations of the State Water Control Law and Regulations of the State Water Control Board. To correct these violations, the Navy was supposed to install a cured-in-place lining in the sewer line adjacent to pump station 1958; submit a maintenance plan for grease traps for approval; submit a line-cleaning plan for specific lines for approval; and submit a map and list of all gravity sewer lines that have experienced overflow problems all by 03/01/03.
3	VA	Henrico County Water Reclamation Facility, Henrico County		This Order addressed violations of environmental laws and regulations, which required the County to begin implementation of the Operation and Maintenance (O&M) manual and maintenance schedule within three months of Department approval of the manual. A schedule for completion of specific I/I projects was supposed to be submitted for approval within two months of this Order.
3	VA	Henrico County Water Reclamation Facility, Henrico County	02/19/98	A Consent Order was issued to Henrico County due to SSOs of sewage from its collection system. In a letter dated 01/08/02, the County reported that all projects outlined in the Consent Order had been completed except for one, which the Order required this project to be completed by 01/01/03.
3	VA	Lorton Correctional Complex STP, District of Columbia Department of Corrections, Fairfax County	08/24/89; Amended 08/20/92 and 08/25/95 and Canceled 04/28/00	The 1989 Order required the District to upgrade the STP in phases to achieve compliance with more stringent permit effluent limits. In 1992, the construction schedule was amended at the District's request and the 1995 Amendment was in response to the District's decision to construct the pumpover system and bring the STP off-line.

Region	State	Case Name/City Name	Effective Date	Description
3	VA	Lorton Correctional Complex STP, District of Columbia Department of Corrections, Fairfax County	05/09/97; Amended 8/15/00	The 1997 order required the District to, among other things, eliminate overflows from the STP and collection system. The District also had to comply with the permit and interim effluent limits and eliminate the STP's discharge or, at a minimum, 0.5 MGD of the discharge, by 08/01/99. A penalty of \$25,000 was assessed. The amended order required the District to maintain an adequate staff of operators at the STP, secure the services of a consultant engineering firm, and install a high-level alarm at the manhole that overflowed at the corrections facility.
3	VA	Massaponax WWTP, County of Spotsylvania	02/19/98	The Order required the County to pay a civil penalty of \$53,200 for permit violations. The Order also required, among other things, that the County operate the WWTP in a workman-like manner, in compliance with the WWTP's Permit and O&M manual, in order to ensure that overflows of raw or partially treated sewage are eliminated.
3	VA	Massaponax WWTP, County of Spotsylvania	Amendment 11/25/98	This amendment required the County to submit revised plans, specifications, and a schedule for review and approval for upgrading and expanding the WWTP to meet specific permit limits; operate the WWTP in a workman-like manner, and complete construction of the upgrade and expansion by 01/15/03.
3	VA	Town of Vinton		This Order addressed I/I issues that occurred in the collection system. Three projects were initiated as a result of this order. The first project was the Wolf Creek Sanitary Sewer Improvements which called for the pump station and part of a gravity sewer pipe to be replaced by 04/01/04. The second project was the Chestnut Mountain Subdivision Sewer System Evaluation and Repairs which called for the Town to complete repairs of the sewer line and associated manholes serving that area by 02/15/05. The third project is the Lindenwood Subdivision Sewer System Evaluation and Repairs which required the Town to complete repairs of the sewer line and the associated manholes in that area by 02/15/08.
3	VA	U.S. Marine Corps, Marine Corps Base Quantico, Quantico Mainside WWTP		This Order resolved certain violations of the State Water Control Law and Regulations, particularly violations of exceeding effluent limitations. By 08/30/02, the Department of Environmental Quality (DEQ) was notified by Quantico that the WWTP's upgrade was completed in accordance to approved plans.
3	WV	City of Parkersburg Utility Board, Parkersburg	08/26/02	In this Order, the City and Parkersburg Utility Board will maximize flows to the treatment plant during both dry and wet weather conditions in order to reduce the number, volume, and duration of discharges from the City's SSOs. The City plans on completing construction of the Long-term SSO Abatement Improvements by 10/31/09. A penalty of \$12,500 was assessed.

Region	State	Case Name/City Name	Effective Date	Description
3	WV	City of South Charleston Sanitary Board and South Charleston Sewage Treatment Company, South Charleston	12/18/98	The City was required to submit a CSO plan, complete and implement the technology based controls established in the Order, and complete an evaluation of water quality impacts. By 06/01/99, they will submit a revised corrective action plan and compliance schedule for the elimination of the 26 SSOs.
3	WV	North Putnam Public Service District, Scott Depot	11/01/00	This Order required the District to proceed with the continued implementation of the I/I identification and elimination measures needed to eliminate extraneous flows, and, in the interim, utilize the temporary sanitary sewer system overflow to alleviate potential adverse conditions.
3	WV	North Putnam Public Service District, Scott Depot	Amended 04/13/01	This amendment requested an extension to the compliance schedule outlined in the 2000 Order.
3	WV	Town of Athens	06/23/99	This Order required the Town to immediately comply with the interim limitations established in the Order. By 06/30/01, the Town will either cease operation of their existing WWTP or have it upgraded to meet the Permit requirements. Construction of the treatment plant upgrade will be complete by 06/30/01.
3	WV	Town of Winfield	04/16/02	The Town was required to immediately proceed with the continued implementation of the I/I identification and elimination measures needed to eliminate extraneous flows, and, in the interim, utilize the temporary sanitary sewer system overflow to alleviate potential adverse conditions.
3	WV	Town of Winfield	Amended 06/06/03	This amendment requested a temporary SSO, actively pursued the necessary processes for identifying and eliminating sources of I/I within the Town's wastewater collection system, and requested an extension to complete the wastewater system improvements and cessation of the temporary SSO.
4	AL	Arab Sewer Board (Arab Riley Maze Creek WWTP)	04/28/00	This Order required them to have a professional, licensed engineer prepare a compliance plan for them to submit. The plan was to evaluate the causes of the bypass and overflow discharges of raw sewage at the treatment plant and make recommendations on how to eliminate or significantly reduce the discharges. A civil penalty of \$2,300 was assessed.
4	AL	Arab Sewer Board (Gilliam Greek WWTP)	04/28/00	This Order required them to have a professional, licensed engineer prepare a compliance plan for them to submit. The plan was to evaluate the causes of the bypass and overflow discharges of raw sewage at the treatment plant and make recommendations on how to eliminate or significantly reduce the discharges. A civil penalty of \$1,300 was assessed.
4	AL	City of Attalla, Attalla Wastewater treatment lagoon	02/26/02	This Order required the City to pay a civil penalty of \$1,200 plus remove pollutants from their discharge during wet weather to the maximum extent possible. Additionally, the City was required to conduct and complete a thorough investigation of the existing treatment works and maintenance and operating procedures of the facility and, prepare and submit a compliance plan.

Region	State	Case Name/City Name	Effective Date	Description
4	AL	City of Cullman, Cullman WWTP	Modification 11/10/99	This Order required the City to execute the necessary contracts for the construction of the new or additional treatment works or modification of existing treatment works necessary to achieve compliance.
4	AL	City of Cullman, Cullman WWTP	10/29/98	This Order established certain deadlines for the City to achieve compliance, which the City later requested extensions for those deadlines due to conditions beyond its reasonable control.
4	AL	City of Moulton	06/19/97	This Order required the City to submit a compliance plan which evaluated the causes of SSOs at the manhole near the intersection of Alabama Highway 24 and 33 and the City and made recommendations on how to eliminate or significantly reduce SSOs and achieve compliance. They were also required to employ a registered professional engineer to inspect the entrance bridge and service road to determine the need for repairs and replacement to ensure reliable access to the facilities.
4	AL	City of Tuscaloosa	11/07/01	The Order required the City to complete the ultraviolet disinfection project and have a substantially complete and operational ultraviolet disinfection system at the wastewater treatment plant by 10/01/03.
4	AL	Decatur Utilities	11/09/00	The Order required them to have a registered professional engineer prepare and submit a compliance plan which evaluated the causes of the bypasses or overflows and made recommendations on how to eliminate or significantly reduce the bypasses or overflows to achieve compliance.
4	AL	Demopolis Water Works and Sewer Board, City of Demopolis	11/23/98	The Order addressed violations of the limitations established in the Permit as indicated by the Discharge Monitoring Reports (DMRs) submitted to the Department by the City. Interim limitations on discharge of pollutants from Outfall 001 into the Tombigbee River were established.
4	AL	Demopolis Water Works and Sewer Board, City of Demopolis	08/02/01	This Order rescinded the 1998 Order and required the City to pay a civil penalty of \$5,300. An engineering report investigating the needs for changes in maintenance and operation procedures and the need for modification of existing treatment works or the need for any new or additional treatment works was supposed to be submitted to the Alabama Department of Environmental Protection (ALDEP) within three months of this Order.
4	AL	Stevenson Utilities Board, Stevenson Wastewater Treatment Lagoon, Stevenson	01/09/02	This Order required them to complete construction and start up the new or additional treatment works or modification of existing treatment works necessary to achieve compliance with Fecal Coliform discharge limitations by 10/14/03. They were also required to complete construction and start up of new pumping stations, SCADA System and upgrade of sewage collection system by 08/30/03. Construction of any additional sewer system rehabilitation was to be complete by 10/22/04.
4	AL	The Water Works and Sewer Board of the City of Anniston, Choccolocco Creek WWTP	06/25/98	This Order required the City to immediately make revisions to the overflow weirs at the headworks of the WWTP and at the Southeastern Area Lift Station to eliminate any leaking of untreated wastewater that resulted in continuous bypasses. They were also required to have a professional, licensed engineer prepare a report outlining the causes of noncompliance and they were supposed to later implement those preventative measures listed in the report.

Region	State	Case Name/City Name	Effective Date	Description
4	AL	Utilities Board of the City of Athens	08/06/97	The City was required to have a professional engineer prepare a compliance plan for the City to submit to the Department no later than 09/30/97. The compliance plan was to evaluate the causes of the SSO's at the cited manholes near the Athens Limestone Hospital and the L&N Railroad overpass and make recommendations on how to eliminate or significantly reduce the SSO's.
4	AL	Utilities Board of the City of Bayou La Batre	01/08/99	The City was required to prepare and submit a Compliance Plan to the Department for approval no later than 03/31/99. The plan will identify causes of effluent limitations violations and describe corrective actions, as well as provide a schedule implementing the Compliance Plan.
4	AL	Utilities Board of the City of Helena	12/03/01	The 1997 Order was rescinded. These Order required them to have a registered professional engineer prepare and submit the plans and specifications to upgrade the existing Helena WWTP to a 4.95 MGD. All construction was supposed to be complete by 11/30/03. In lieu of paying the \$100,000 civil penalty, they performed a Supplemental Environmental Project (SEP) which consisted of the construction of a new pump station in the park area.
4	AL	Utilities Board of the City of Helena	08/22/97	This Order to addressed 53 SSOs in 1996 at several manhole locations in the collection system. The 53 SSO's resulted in a total of 29,330,000 gallons of raw sewage overflow from its collection system. They were required to submit a compliance plan schedule to resolve the violations. They failed to meet the milestones of two engineering activities, did not complete the replacement of the main pumping station at the scheduled date, and failed to expand the existing Helena WWTP to a 4.95 MGD plant.
4	FL	South Cross Bayou WWTF, Pinellas County, Clearwater	04/20/94	The Order authorized the County to proceed with the corrective actions outlined in the document and temporarily operate the WWTP and injection well system for a period of five years. They were also required to pursue construction and implementation of a County regional reuse system and upgrade the Facility to Advanced Wastewater Treatment (AWT) to include surface water discharge for backup disposal. A stipulated penalty of \$36,000 was assessed.
4	NC	Belmont City-A Sludge/Lars	10/30/01	
4	NC	Mebane Bridge WWTP	01/25/02	
4	NC	Morrisville Town-Carpenter	04/11/00	
4	NC	Murfreesboro Town WWTP	10/11/00	
4	NC	Neuse Crossing WWTP	02/17/00	
4	NC	Pond Creek WWTP	01/25/02	
4	NC	Sanford WWTP	11/25/02	
4	NC	Sanford WWTP	07/09/03	
4	NC	Town of Canton	03/27/00	
4	NC	Town of Green Level	03/16/01	
4	NC	Warsaw WWTP	08/03/00	

Region	State	Case Name/City Name	Effective Date	Description
4	SC	Bath and Water and Sewer District, Aiken County	08/21/97	This Order required the County to clean out the sewer line within three days of the Order and replace the section of sewer line from the main trunk line to the edge of the property at 15 Hill Street within four months of the Order. A \$10,000 civil penalty was suspended.
4	SC	Berkeley County Water and Sanitation Authority, Lower Berkely WWTF, Berkeley County	05/07/02	The Order required the County to submit a summary report of corrective actions taken to prevent future unauthorized discharges. A civil penalty of \$9,900 was assessed.
4	SC	City of Hanahan	03/20/00	The City was required in this Order to complete development of a comprehensive CMOM program and implementation of the initial system audit and by 09/01/00, submit a summary detailing the findings of the initial audit. A civil penalty of \$11,200 was assessed.
4	SC	City of Hardeeville	02/28/02	The Order addressed the discharge of sewage into the environment not in compliance with their permit and failure to properly operate and maintain, at all times, all waste treatment systems. An \$8,000 civil penalty was assessed.
4	SC	City of Lancaster	01/27/97	This Order addressed raw sewage leaking from an exposed polyvinyl chloride (PVC) line under a bridge and from an abandoned line adjacent to the bridge decreased dissolved oxygen levels below stream standards resulting in a fish kill. As a result of this violation, the City was required to submit a schedule to survey the collection system as well as a schedule to inspect the collection system on a routine basis. A civil penalty of \$12,000 was assessed plus \$3,061.35 for the cost of the fish kill.
4	SC	City of Lancaster	07/31/01	The Order required the City to begin developing a Capacity, Management, Operation, and Maintenance (CMOM) audit for the wastewater collection system. A summary report of corrective actions addressing deficiencies in the wastewater collection system and ammonia-nitrogen and toxicity were also to be submitted.
4	SC	City of Lancaster, Catawba River Plant, Lancaster County	11/30/99	This Order addressed an unauthorized discharge caused by an overflowing manhole. The City was required to submit a SSES study plan outlining plans for evaluation of the deficiencies within its sewer system.
4	SC	City of Rock Hill/ Manchester Creek	01/09/01	This Order required the City to submit a corrective action plan for compliance with the permitted discharge limits for fecal coliform. A corrective action plan and schedule was also required to address priority deficiencies in the wastewater collection system (pump stations, manholes, line breaks/ deteriorations, etc.). Within six months of the Order and every six months until the Order is closed, they were supposed to submit a summary report of corrective actions addressing deficiencies in the wastewater collection system. A civil penalty of \$23,000 was assessed.

Region	State	Case Name/City Name	Effective Date	Description
4	SC	City of Rock Hill/ Manchester Creek	06/19/97	This Order addressed, among other things, violations of the permitted discharge limits for fecal coliform bacteria, total residual chlorine, and total suspended solids.
4	SC	East Richland County Public Service District, Richland County	07/27/01	The Order required the County to begin development of a CMOM audit and to submit a corrective action plan and schedule to address priority deficiencies in the wastewater collection system (pump stations, manholes, line breaks/deterioration, etc.). Within six months of the Order and every six months until the Order is closed, the County was also supposed to submit a summary report of corrective actions addressing deficiencies in the wastewater collection system.
4	SC	East Richland County Public Service District/Gills Creek WWTP, Richland County	06/29/98	The Order required the County to submit an administratively complete Preliminary Engineering Report addressing upgrade of the effluent pump station and the elimination of the Gills Creek discharge point. They were also required to submit an I/I study, outlining deficiencies in the waste disposal system and a schedule for completion of the study and of any necessary repairs.
4	SC	McCormick County Water and Sewer, McCormick County	07/21/03	This Order required the County to implement and re-evaluate the approved MOM program, submit a schedule for lift station inspections, submit a report of reduction of SSOs during the most recent 12 months, and submit a schedule plan to pump out interceptor tanks in Savannah Lakes Village including disposal sites.
4	SC	McCormick County Water and Sewer, McCormick County	08/19/02	The Ordered required the County to immediately begin inspecting all lift stations on a daily basis or have them equipped with telemetry monitoring. The lift station inspection records were supposed to be maintained for at least three years. Additionally, the Order required the County to submit a report identifying the reduction of SSOs since 01/01/00, as a result of compliance requirements of the 1999 Consent Order, as well as submit a five year on-going schedule to pump out interceptor tanks in Savannah Lakes Village, and submit "Sanitary Sewer Overflow or Pump Station Failure Forms" for unreported SSOs identified.
4	SC	McCormick County Water and Sewer, McCormick County	12/14/99	The County agreed to operate and maintain the wastewater collection system, develop and implement a CMOM program, evaluate all lift stations and take corrective actions accordingly, report all SSOs, and pay a penalty.

Region	State	Case Name/City Name	Effective Date	Description
4	SC	Spartanburg Sanitary Sewer District/Fairforest Plant, Spartanburg County	06/09/99	The Order required the County to submit a Sewer System Evaluation Survey (SSES) study plan and later results for both, Camp Croft collection system and Fairforest Drainage Basin. The plans were supposed to have an implementation schedule for the phases of the SSES. A comprehensive Management, Operation, and Maintenance program (MOM) for the entire wastewater collection system was also to be submitted along with a corrective action plan detailing operation and maintenance procedures and/or pretreatment program modifications. At civil penalty of \$36,000 was assessed.
4	SC	Town of Carlisle	09/02/99	This Order required the Town to obtain a generator capable of operating the lift stations during power outages, submit a SSES study plan for the Westwood and Clearbranch subsystems along with an implementation schedule for the phases of the SSES, submit the results of the Phase I of the SSES, and submit a MOM plan for the entire wastewater collection system.
4	SC	Town of Chesterfield	10/01/02	The Order required the Town to submit a summary of corrective actions taken to prevent SSOs, implement temporary measures to prevent SSOs at the high school lift stations and submit a summary report detailing the measures taken, submit a corrective action plan for the upgrade of the high school lift station, begin development of CMOM audit, submit a corrective action plan and schedule to address priority deficiencies in the wastewater collection system, and within six months of the Order and every six months after the Order is closed, submit a summary report of corrective actions addressing deficiencies in the wastewater collection system.
4	SC	Town of Fort Mill	05/03/00	The Order required the Town to begin development of a CMOM audit and to submit a corrective action plan and schedule to address priority deficiencies in the wastewater collection system (pump stations, manholes, line breaks/ deterioration, etc.). Within six months of the Order and every six months until the Order is closed, the County was also supposed to submit a summary report of corrective actions addressing deficiencies in the wastewater collection system. A civil penalty of \$11,200 was assessed.
4	SC	Town of McColl	07/22/02	The Town was required to begin development of a cMOM audit, submit a corrective action plan and schedule to address priority deficiencies in the wastewater collection system, and within six months after the Order and every six months after the Order is closed, submit a summary report of corrective actions addressing deficiencies in the wastewater collection system.
4	SC	Town of Pamplico	05/17/00	The Order required the Town to submit a corrective action plan detailing measures taken or to be taken to prevent overflows. They were also required to submit detailed reports of all I/I work performed, including flow isolation and visual manhole inspections. A civil penalty of \$10,200 was assessed.

Region	State	Case Name/City Name	Effective Date	Description
4	SC	Town of Varnville	08/11/97	The Order addressed the Town allowing unauthorized discharges of untreated wastewater into the environment. As a result, the Town was required to notify the Department verbally within 24 hours of a spill and follow-up with a written description within five days. A civil penalty of \$3,500 was assessed.
4	SC	Western Carolina Regional Sewer Authority, Greenville County	06/09/99	This Order required the County to submit a study plan for instream water quality assessment of fecal coliform bacteria, implement the water quality assessment for fecal coliform bacteria, submit a study plan for a biological assessment around the collection systems, and pay a civil penalty of \$82,000.
4	TN	Athens Utilities Board	01/05/99	The Order required the City to submit to the Chattanooga Environmental Assistance Center (CEAC) an engineering report by 08/15/99.
4	TN	City of Alexandria	07/19/00	The City was required to complete construction of the approved wastewater treatment plant (WWTP) additions and/or improvements by 08/31/01.
4	TN	City of Alexandria	10/02/02	The City was required to complete construction of the WWTP facility by 10/31/02. Of the total \$104,000 penalty, \$7,500 will be due within one month of this Order and the remainder will be contingent with fulfilling the remaining tasks.
4	TN	City of Bluff City	07/28/98	This Order required the City to complete construction of the sewer connection by 05/15/98, and complete closure of the WWTP, without the bypass of sewage, within three months of the systems connection to the City of Bristol Utilities. A penalty of \$17,750 was assessed, of which \$2,250 was due within one month of this Order, and the remainder was contingent upon fulfilling required tasks.
4	TN	City of Church Hill	04/02/97	This Order required the City to notify the Tennessee Department of Environment and Conservation (TNDEC) of all sewage facility projects constructed or under construction without the Department's approval within one month of this Order. A penalty of \$5,000 was due within one month of this Order.
4	TN	City of Copperhill	10/21/99	The City was required to have two adequately sized and operational pumps installed at the City's lift station by 12/01/99, as well as have two adequately sized and operational return activated sludge pumps installed at the WWTP.
4	TN	City of East Ridge	04/29/96	This Order required the City to complete the approved Corrective Action Plan by 12/31/98. A \$30,000 contingent penalty was assessed.
4	TN	City of Franklin	10/26/99	The Order addressed, among other things, permit violations. The City was required to pay a damage fee of \$6,326 and a civil penalty of \$3,750.
4	TN	City of Franklin	11/13/00	This Order required the City to implement all remedial measures detailed in the approved report within six months of this Order. Of the total \$57,500 civil penalty, \$15,000 will be due within one month of this Order and the remainder will be contingent of fulfilling the remaining tasks.
4	TN	City of Greenbrier	03/20/00	This Order required the City to complete the WWTP upgrade/expansion and interceptor improvements within nine months of start of construction or, by 03/01/01. Of the total \$141,750 penalty, \$1,500 will be due within one month of this Order and the remainder will be contingent with fulfilling the remaining tasks.

Region	State	Case Name/City Name	Effective Date	Description
4	TN	City of Harriman	06/28/00	This Order required the City to complete the WWTP upgrade/expansion and interceptor improvements within 14 months of start of construction or, by 03/01/03. Of the total \$266,250 penalty, \$30,000 will be due within one month of this Order and the remainder will be contingent with fulfilling the remaining tasks.
4	TN	City of Harriman	07/23/02	The City was required to complete construction of Woodyard Pump Station/Force Main by 06/31/03, complete construction/rehabilitation of the South Harriman Pump Stations by 12/15/03, and complete construction of WWTP project by 03/01/04. A penalty of \$30,000 will be due within one month of this Order.
4	TN	City of Jefferson City	06/04/01	The City was required to complete construction of the WWTP improvement project by 01/31/02.
4	TN	City of Jellico	10/03/97	This Order required the City to complete collection system repairs and treatment plant upgrades/ expansion, and implement an ongoing program for collection system rehabilitation. Of the total \$11,500 penalty, \$1,500 will be due within one month of this Order and the remainder will be contingent with fulfilling the remaining tasks.
4	TN	City of Kingston	11/30/01	This Order required the City to complete the implementation of the Corrective Action Plan and within three months of complete implementation, the City will be in full compliance with its NPDES permit. Of the total \$207,000 penalty, \$5,000 will be due within one month of this Order and the remainder will be contingent with fulfilling the remaining tasks.
4	TN	City of Lafayette	04/22/03	The City was required to complete construction of the WWTP upgrade. Of the total \$92,500 penalty, \$7,500 will be due within one month of this Order and the remainder will be contingent with fulfilling the remaining tasks.
4	TN	City of LaVergne	11/08/99	This Order addressed the discharge of wastewater and raw sewage overflowing from manholes. A civil penalty fee of \$2,500 will be due within one month of this Order.
4	TN	City of LaVergne	10/24/00	The Order addressed, among other things, permit violations. A civil penalty fee of \$2,000 will be due within one month of this Order.
4	TN	City of Lawrenceburg	11/19/98	This Order required the City to complete repairs to the WWTP and collection system by 02/15/99.
4	TN	City of Lawrenceburg	03/27/01	This Order required the City to complete the installation of the new sludge filter belt press in the WWTP by 03/01/01. A penalty fee of \$9,375 will be due within one month of this Order..
4	TN	City of Middleton	11/10/98	The Order required the City to complete construction by 09/30/00.
4	TN	City of Middleton	08/25/00	The Order required the City to complete construction of the proposed upgrades to the existing lagoon, the modifications to the force main, and the replacements of the effluent pumps. Additionally, within six months of this Order, the City will complete construction of the parallel force main. Of the total \$47,750 penalty, \$5,000 will be due within one month of this Order and the remainder will be contingent with fulfilling the remaining tasks.

Region	State	Case Name/City Name	Effective Date	Description
4	TN	City of Murfreesboro	08/21/99	The City was required to complete the expansion of the sewer treatment plant and place the sewer treatment plant into full operation by 01/31/00. As a result, the Town was charged a damage fee of \$12,107 in addition to the penalty of \$400,000. Of the total penalty, \$50,000 was due within one month of this Order and the remainder was to be contingent upon fulfilling the required tasks.
4	TN	City of Murfreesboro	05/22/01	The Order requested that the City perform a Supplemental Environmental Project (SEP) in lieu of paying the \$50,000 civil penalty. The City was to purchase a five acre lot, which had a wetland and protect, in perpetuity, the aesthetic, educational, or ecological values of this wetland.
4	TN	City of Portland Public Works	08/02/02	The Order addressed discharges into waters of the U.S. without a NPDES permit and causing a condition of pollution that resulted in a fish kill. The damage fee totaled \$541.11 and the penalty fee totaled \$5,000.
4	TN	City of Pulaski	05/08/98	The Order required the City to submit to the Division of Water Pollution Control a plan to eliminate permit limit violations by 06/15/98.
4	TN	City of Red Bank	02/25/97	The Order required the City to implement and complete the approved 1997 Sewer Rehabilitation and Corrective Action Plan and, if necessary, additional collection system improvements by 09/30/01. Of the total \$164,500 penalty, \$10,000 will be due in increments by 09/01/97.
4	TN	City of Rockwood	10/29/98	This Order required the City to complete the Corrective Action Plan and obtain full compliance with its NPDES permit by 08/01/01. Of the total \$16,750 penalty assessed, \$1,500 was due within one month of this Order and the remainder was to be contingent upon fulfilling required tasks.
4	TN	City of Sparta	10/04/00	The Order required the City to submit a report evaluating the effectiveness of the WWTP upgrade/expansion. Additionally, the city was required to submit a Corrective Action Plan to address the collection system I/I problems. Of the total \$62,000 penalty, \$7,500 will be due within one month of this Order and the remainder will be contingent with fulfilling the remaining tasks.
4	TN	City of Watertown	02/08/00	This Order addressed effluent discharge violations. A civil penalty of \$1,100 will be due within one month of this Order.
4	TN	City of Watertown	06/03/03	This Order required the City to complete construction of the wastewater collection system and WWTP improvements by 08/31/03. Of the total \$87,500 penalty, \$10,500 will be due in increments by 03/31/04.
4	TN	Knoxville Utilities Board	05/20/03	This Order required a Phase I Corrective Action Plan/Engineering Report to be submitted within ten months of receiving comments from the Department. A Phase II Corrective Action Plan/Engineering Report was required to be submitted by 06/30/06. A contingent penalty was assessed at \$475,000.
4	TN	Lenoir City Utilities Board	01/03/01	This Order required the Board to complete collection system improvements by 07/31/01 and to complete all planned WWTP improvements by 12/31/01. They were also required to complete construction of approved additions and/or improvements within 18 months of start of construction or, by 06/30/05.
4	TN	Lynnwood Utility Corporation	No date provided	The Order addressed permit violations. A civil penalty of \$5,000 will be due within one month of this Order.

Region	State	Case Name/City Name	Effective Date	Description
4	TN	Metropolitan Government of Nashville and Davidson County	09/17/99	The City and County were required to have all CSO controls, including but not limited to, floatable material and debris removal, combined sewage storage and/or detention and CSO elimination, in place by 07/01/01. The City and County were also supposed to eliminate all overflows or bypassing from its sanitary sewers to all waters of the state by 07/01/01. Of the total \$600,000 penalty assessed, \$100,000 was due within one month of this Order. However, the City and County had the option to perform a SEP in lieu of paying the \$100,000.
4	TN	Town of Collierville	06/03/98	The Town was required to complete the installation of the new return sludge pumping system within three months of this Order. They were also required to complete the new aerated lagoon treatment plant within two months of this Order. Of the total \$118,500 penalty, \$5,000 was due within one month of this Order and the remainder was contingent with fulfilling the remaining tasks.
4	TN	Town of Gainesboro	11/22/00	The Order required the Town to complete construction on the WWTP upgrade/expansion by 09/01/02. Of the total \$67,625 penalty, \$6,500 will be due within one month of this Order and the remainder will be contingent of fulfilling the remaining tasks.
4	TN	Town of Gainesboro	03/27/01	This Order required the Town to complete construction on the WWTP upgrade/expansion by 03/01/03. A penalty of \$5,500 will be due within one month of this Order.
4	TN	Town of Monterey	09/11/02	The Town was required to complete the implementation of the Corrective Action Plan and obtain full compliance with its NPDES permit within three years of approval. As a result, the Town was charged a damage fee of \$6,413 in addition to the penalty of \$115,500. Of the total penalty, \$12,500 was be due within one month of this Order and the remainder was to be contingent upon fulfilling required tasks.
4	TN	Town of Mosheim	04/25/01	The Order required the Town to complete construction on the WWTP upgrade/ expansion by 06/01/01 and complete the I&I rehabilitation by 12/31/01. A civil penalty of \$3,000 will be due within one month of this Order.
4	TN	Town of Pikeville	01/09/00	This Order required the Town to submit a pretreatment program for approval and, within one year of this Order, be in compliance with its NPDES permit. Of the total \$58,250 penalty, \$4,125 will be due within one month of this Order and the remainder will be contingent with fulfilling the remaining tasks.
4	TN	Town of Spring City	07/31/03	The Order required the Town to submit a plan for approval to comply with permit requirements and within 12 months of approval, the plan will be implemented. Of the total \$15,000 penalty, \$5,000 will be due within one month of this Order and the remainder will be contingent with fulfilling the remaining tasks.
4	TN	Town of Spring Hill	06/04/99	The Town was required to implement a plan to prevent any future bypassing in the Pipkin Hills subdivision area by 09/01/99.
4	TN	Town of Spring Hill	01/26/00	The Order required the Town to complete the Corrective Action Plan and obtain full compliance with its NPDES permit by 01/01/01. Of the total \$73,312 penalty, \$1,312 will be due within one month of this Order and the remainder will be contingent with fulfilling the remaining tasks.

Region	State	Case Name/City Name	Effective Date	Description
5	IN	City of Batesville	03/23/01	
5	IN	City of Brazil	12/09/93; Amended 10/95	
5	IN	City of Brazil	12/07/99	
5	IN	City of Charlestown	04/03/02	
5	IN	City of Dunkirk	05/28/93	
5	IN	City of Elwood	10/04/93	
5	IN	City of Garrett	12/13/02	
5	IN	City of Gas City	03/25/91	
5	IN	City of Gas City	11/07/02	
5	IN	City of Greencastle	05/11/99	
5	IN	City of Greenwood	07/25/97	
5	IN	City of Indianapolis		Referred to EPA 08/20/02.
5	IN	City of Jasonville	12/20/93	The City was required to submit a Compliance Plan, including a schedule with fixed dates for each milestone and a reasonable date for final compliance. They were also required to initiate the work detailed in the plan within 30 days of being fully approved and complete the work according to the plan's schedule.
5	IN	City of Lawrence	01/04/99; Amended 9/26/00	The City was required to develop and submit to IDEM its Compliance Plan for IDEM approval.
5	IN	City of Madison	12/10/97	
5	IN	City of New Albany	05/09/97	
5	IN	City of Portland	03/30/93	
5	IN	City of Rockport	01/29/03	
5	IN	City of Salem	09/18/96	
5	IN	City of Salem	08/18/98	
5	IN	City of Scottsburg	07/23/03	
5	IN	Community University of Gary	08/07/91	
5	IN	Henryville	10/31/01	
5	IN	Town of Advance	07/28/03	
5	IN	Town of Albany	11/30/00	
5	IN	Town of Ashley	09/11/01	
5	IN	Town of Austin	05/11/98	
5	IN	Town of Bristol	11/10/98	
5	IN	Town of Brooklyn	10/20/98	
5	IN	Town of Carthage	01/12/99	
5	IN	Town of Cedar Lake	03/04/99	
5	IN	Town of Churubusco	06/24/03	
5	IN	Town of Clay City	03/05/02	
5	IN	Town of Converse	02/23/99	
5	IN	Town of Cumberland	02/01/02	
5	IN	Town of Dillsboro	05/01/03	The Town was required to submit a Compliance Plan detailing the construction of the new oxidation ditch wastewater treatment system, including an implementation and construction schedule within three months of this Order.
5	IN	Town of Elizabethtown	11/27/91; Amended 05/20/98	
5	IN	Town of Farmersburg	08/08/02	

Region	State	Case Name/City Name	Effective Date	Description
5	IN	Town of Farmland	05/09/03	
5	IN	Town of Flora	04/30/92; Amended 06/20/03	
5	IN	Town of Fort Branch	03/23/01	
5	IN	Town of Fountain City	09/30/02	The Town was required to develop and submit to Indiana Department of Environmental Management (IDEM) for approval a Compliance Plan which identified actions the Town was to take in order to achieve compliance within six months of this Order. This included eliminating sewer system overflows (SSOs).
5	IN	Town of French Lick	11/12/93	This Order required the Town to complete construction of its I/I removal project by 12/21/94, complete construction of its sewage treatment plant by 06/30/97, and complete the necessary actions to assure that the downspouts and the sump pumps do not connect with the sewage treatment plant.
5	IN	Town of Galveston	07/02/02	The Town was required to immediately implement the approved Compliance Plan and adhere to the milestone dates.
5	IN	Town of Geneva	04/29/03	
5	IN	Town of Grabill	02/07/02	
5	IN	Town of Grandview	01/21/99	
5	IN	Town of Greentown	03/18/98	
5	IN	Town of Hanover	03/07/01	
5	IN	Town of Hartsville	01/27/00	
5	IN	Town of Haubstadt	08/10/94	The Town was required to submit to IDEM a Compliance Plant which included an implementation schedule.
5	IN	Town of Jonesboro	06/17/94	
5	IN	Town of LaGrange	03/18/98	
5	IN	Town of Lapel	11/21/97	
5	IN	Town of Leavenworth	07/23/01	This Order required the City to develop and submit to IDEM its Compliance Plan for IDEM approval.
5	IN	Town of Lynnville	07/28/03	
5	IN	Town of Milan	05/22/98	
5	IN	Town of Montpelier	09/20/93	
5	IN	Town of Moores Hill	09/26/00	
5	IN	Town of Mt. Etna	11/16/98	
5	IN	Town of Mulberry	10/18/98	
5	IN	Town of New Providence	12/28/98	
5	IN	Town of Palmyra	01/02/01	
5	IN	Town of Paoli	05/12/97	The Town was required to complete sludge handling improvements to assure NPDES compliance, complete a Sewer System Evaluation Study (SSES), and submit a list of I/I sources found and corrected.
5	IN	Town of Parker City	05/23/94	
5	IN	Town of Parker City	01/02/01	
5	IN	Town of Pierceton	11/18/98; Amended 06/24/03	
5	IN	Town of Remington	06/06/03	
5	IN	Town of Riley	12/12/02	
5	IN	Town of Rockville	07/22/97	
5	IN	Town of Rome City	05/12/00	
5	IN	Town of Santa Claus	06/01/01	

Region	State	Case Name/City Name	Effective Date	Description
5	IN	Town of Schererville	08/15/91	
5	IN	Town of Sellersburg	12/14/00	
5	IN	Town of Staunton	09/26/00	The Town was required to develop and submit to IDEM a Compliance Plan for approval.
5	IN	Town of Sweetser	01/29/02	
5	IN	Town of Trafalgar	01/26/95	
5	IN	Town of Upland	06/06/94; Amended 12/01	
5	IN	Town of Upland	01/12/01	
5	IN	Town of West College Corner	12/18/97	Later referred to EPA.
5	IN	Town of Whitestown	05/01/01	
5	IN	Town of Wolcottville	06/20/02	
6	LA	City of Pineville	05/31/02	The Order required them to submit a comprehensive plan for the expeditious elimination and prevention of non-complying discharges and complete a written report to include a detailed description of the circumstances of the violations, the actions taken to achieve compliance, and corrective or remedial actions taken to mitigate any damages.
6	LA	City of Ruston	12/16/99	Under this Order, they were required to cease all unauthorized discharges, meet and maintain compliance with their Permit, submit a written report to include a detailed description of the circumstances for the violations and the actions taken to achieve compliance, and to submit a schedule for corrections.
6	LA	City of Ruston	05/31/01	This Order required them to immediately cease unauthorized discharges to the waters of the state or any unenclosed areas that drain to the waters of the state, submit a comprehensive plan for the expeditious elimination and prevention of the noncomplying discharges, complete a written report to include a detailed description of the circumstances for the violations, the actions taken to achieve compliance, and any corrective or remedial actions taken.
6	LA	City of Ruston	Amendment 11/29/2001	The Order required the City to complete repairs/replacement of U.S. Highway 80 East force main by 06/15/02, complete rehabilitation of the clarifiers by 01/15/03, and complete construction of the WWTF/pump station/ force main by 12/31/06.
6	LA	City of Ruston	07/11/97	This Order required the City to immediately cease all unauthorized discharges from the facility to the waters of the state, submit a comprehensive plan for the expeditious elimination and prevention of noncomplying discharges, and submit a completed Louisiana permit application.
6	LA	City of Ruston	04/29/98	This Order addressed the discharge of inadequately treated sanitary wastewater.
6	LA	City of Ruston	12/16/99	This Order required the City to submit a written report detailing the circumstances for the violations, actions taken to achieve compliance, and corrective or remedial actions taken to mitigate damages. They were also required to submit a comprehensive plan for the expeditious elimination and prevention of noncomplying discharges.
6	LA	City of Westwego	04/27/98	This Order addressed the City's O&M deficiencies, sampling deficiencies, and violations of effluent limitations.

Region	State	Case Name/City Name	Effective Date	Description
6	LA	City of Westwego	04/24/01	This Order addressed the City's the violation of effluent limitations, operation and maintenance requirements, and self-monitoring programs. The Order required them to immediately cease unauthorized discharges to the waters of the state, submit a written report to include the circumstances for the violations, and submit a comprehensive plan for the elimination and prevention of such non-complying discharges.
6	LA	City of Westwego	08/29/02	This Order required them to immediately cease unauthorized discharges to the waters of the state, submit semi-annual progress reports until completion of proposed improvements, and to complete a written report to include a detailed description of the circumstances for the violations, the actions taken to achieve compliance, and corrective or remedial actions taken to mitigate any damages resulting from the violations.
6	LA	City of Westwego	12/24/02	This Order addressed the City's failure to properly operate and maintain its facility.
6	OK	Bethany/Warr Acres Public Works Authority	03/09/00 Closed	This Order addressee bypasses of untreated wastewater.
6	OK	Bixby Public Works Authority		This Order addressed discharges without a permit.
6	OK	Bixby Public Works Authority		This Order addressed discharges without a permit.
6	OK	Blackwell Municipal Authority		This Order addressed unpermitted bypasses.
6	OK	Bokoshe Public Works Authority	05/23/02	This Order addressed discharges without a permit. The Authority was required to complete construction of the new collection system by 01/01/04.
6	OK	Carney Public Works Authority	06/01/98 Closed	This Order addressed exceeding discharge limits.
6	OK	Checotah Public Works Authority	12/17/99 Closed	This Order addressed discharges without a permit.
6	OK	Checotah Public Works Authority	10/01/95 Closed	This Order addressed discharge violations.
6	OK	Chouteau Public Works Authority	04/11/97 Closed	This Order addressed violation of discharge permit.
6	OK	City + A153 of McAlester	12/01/99 Closed	This Order addressed discharges without a permit.
6	OK	City of Ada	03/08/01 Closed	This Order addressed the City discharging without a permit.
6	OK	City of Altus	06/14/95 Closed	This Order addressed unpermitted discharges.
6	OK	City of Apache	11/30/00 Closed	This Order addressed discharges without a permit.
6	OK	City of Ardmore	12/01/99 Closed	This Order addressed discharges without a permit.
6	OK	City of Atoka	01/11/94 Closed	This Order addressed discharges without a permit.
6	OK	City of Bartlesville	07/12/93 Closed	This Order addressed unauthorized bypasses.
6	OK	City of Bethany	06/12/02	This Order addressed discharges without a permit. The City was required to complete construction of the lift station upgrades by 04/01/03.
6	OK	City of Blackwell		This Order addressed failure to report bypasses.
6	OK	City of Broken Bow		This Order addressed discharges without a permit.

Region	State	Case Name/City Name	Effective Date	Description
6	OK	City of Bulter	07/28/99 Closed	This Order addressed discharges without a permit.
6	OK	City of Chandler		This Order addressed discharges without a permit.
6	OK	City of Claremore	07/26/99 Closed	This Order addressed discharges without a permit.
6	OK	City of Claremore		This Order addressed discharges without a permit.
6	OK	City of Cleveland		This Order addressed discharges without a permit.
6	OK	City of Clinton		This Order addressed discharges without a permit.
6	OK	City of Clinton	10/10/94 Closed	This Order addressed violation of discharge permit.
6	OK	City of Cordell	12/01/99 Closed	This Order addressed violation of discharge permit.
6	OK	City of Corn	10/16/98 Closed	This Order addressed discharges without a permit.
6	OK	City of Coweta	04/11/97 Closed	This Order addressed discharges without a permit.
6	OK	City of Davis	12/15/99 Closed	This Order addressed unpermitted bypass from manholes.
6	OK	City of Del City	11/19/98 Closed	This Order addressed discharges without a permit.
6	OK	City of Durant		This Order addressed discharges without a permit.
6	OK	City of Durant	01/26/96 Closed	This Order addressed discharges without a permit.
6	OK	City of Durant	10/10/95 Closed	This Order addressed unpermitted bypasses.
6	OK	City of El Reno		This Order addressed discharges without a permit.
6	OK	City of El Reno	04/24/00 Closed	This Order addressed discharges without a permit.
6	OK	City of El Reno	11/16/00 Closed	This Order addressed unreported sewage bypasses.
6	OK	City of El Reno	07/10/95 Closed	This Order addressed discharges without a permit.
6	OK	City of El Reno		This Order addressed discharges without a permit.
6	OK	City of El Reno	07/10/95 Closed	This Order addressed discharges without a permit.
6	OK	City of El Reno	08/01/97 Closed	This Order addressed discharges without a permit.
6	OK	City of Elgin		This Order addressed discharges without a permit.
6	OK	City of Elk City	02/13/97 Closed	This Order addressed exceeding discharge limits.
6	OK	City of Elk City	10/01/95 Closed	This Order addressed exceeding discharge limits.
6	OK	City of Elmore City	10/21/02	This Order addressed discharges without a permit. The City was required to complete construction on the collection system upgrades by 12/01/03.
6	OK	City of Enid	02/05/01 Closed	This Order addressed discharges without a permit.
6	OK	City of Enid	06/12/01 Closed	This Order addressed discharges without a permit.
6	OK	City of Fairview	07/10/95 Closed	This Order addressed discharge violations.
6	OK	City of Fairview	05/19/95 Closed	This Order addressed violation of discharge permit.
6	OK	City of Glenpool	03/06/01 Closed	This Order addressed exceeding discharge limits.
6	OK	City of Guthrie		This Order addressed bypasses.

Region	State	Case Name/City Name	Effective Date	Description
6	OK	City of Haileyville	03/15/99 Closed	This Order addressed discharges without a permit.
6	OK	City of Haileyville	08/27/96 Closed	This Order addressed discharges without a permit.
6	OK	City of Hartshorne	02/22/96 Closed	This Order addressed bypass from manhole.
6	OK	City of Healdton	08/01/02	This Order addressed discharges without a permit. The City was required to complete construction on the collection system upgrades by 12/01/03.
6	OK	City of Heavener	05/25/99 Closed	This Order addressed discharge of sewer, failure to sample, and bypassing.
6	OK	City of Heavener	05/25/99 Closed	This Order addressed discharges without a permit.
6	OK	City of Henryetta		This Order addressed discharges without a permit.
6	OK	City of Henryetta	07/11/95 Closed	This Order addressed discharges without a permit.
6	OK	City of Henryetta	10/10/95 Closed	This Order addressed discharges without a permit.
6	OK	City of Hobart		This Order addressed discharges without a permit.
6	OK	City of Hobart		This Order addressed discharges without a permit.
6	OK	City of Holdenville	11/07/02	This Order addressed discharges without a permit. The City was required to complete construction of improvements at the Heritage Village by 09/01/03, and complete construction of improvements to eliminate the connections between the storm sewer and the sanitary sewer systems within 12 months of obtaining adequate funding.
6	OK	City of Holdenville	05/30/97 Closed	This Order addressed discharges without a permit.
6	OK	City of Holdenville	07/11/95 Closed	This Order addressed discharges of sewage effluent.
6	OK	City of Hollis	12/01/99 Closed	This Order addressed discharges without a permit.
6	OK	City of Hooker	10/29/01 Closed	This Order addressed discharges without a permit.
6	OK	City of Hugo	09/25/98 Closed	This Order addressed discharges without a permit.
6	OK	City of Hugo	02/01/00 Closed	This Order addressed discharges without a permit.
6	OK	City of Hugo	08/14/98 Closed	This Order addressed discharges without a permit.
6	OK	City of Hugo	06/21/00 Closed	This Order addressed discharges without a permit.
6	OK	City of Idabel	07/01/96 Closed	This Order addressed discharges without a permit.
6	OK	City of Kingfisher		This Order addressed discharges without a permit.
6	OK	City of Kingfisher	12/17/01 Closed	This Order addressed discharges without a permit.
6	OK	City of Konawa	11/14/95 Closed	This Order addressed discharges without a permit.
6	OK	City of Lawton	01/17/03	The City was required to complete construction/rehabilitation of Phase I by 07/01/05, and complete the flow monitoring assessment for Phase I by 01/01/06. The City was also required to complete construction/rehabilitation of Phase II by 07/01/12, and complete the flow monitoring assessment for Phase II by 01/01/13.
6	OK	City of Lawton		This Order addressed discharges without a permit.

Region	State	Case Name/City Name	Effective Date	Description
6	OK	City of Madill	08/27/96 Closed	This Order addressed the inadequate facility to treat sewage effluent.
6	OK	City of Marland	10/10/95 Closed	This Order addressed discharge permit violations.
6	OK	City of McAlester	04/15/98 Closed	This Order addressed discharges without a permit.
6	OK	City of McAlester	07/11/95 Closed	This Order addressed discharges without a permit.
6	OK	City of McAlester	07/11/95 Closed	This Order addressed discharges without a permit.
6	OK	City of Minco	10/01/95 Closed	This Order addressed the discharge of sewage effluent to Buggy Creek.
6	OK	City of Moore		This Order addressed discharges without a permit.
6	OK	City of Moore	07/11/95 Closed	This Order addressed discharges without a permit.
6	OK	City of Morris		This Order addressed failure to obtain a discharge permit.
6	OK	City of Noble		This Order addressed discharges without a permit.
6	OK	City of Noble		This Order addressed discharges without a permit.
6	OK	City of Norman	05/24/96 Closed	This Order addressed bypass violations.
6	OK	City of Nowata	05/18/01 Closed	This Order addressed discharges without a permit.
6	OK	City of Nowata		This Order addressed unpermitted bypasses.
6	OK	City of Oklahoma City	03/21/01 Closed	This Order addressed discharges without a permit.
6	OK	City of Oklahoma City		This Order addressed noncompliance with discharge procedures.
6	OK	City of Okmulgee	09/23/97 Closed	This Order addressed discharges without a permit.
6	OK	City of Okmulgee	06/20/01 Closed	This Order addressed discharges without a permit.
6	OK	City of Okmulgee	04/17/00 Closed	This Order addressed discharges without a permit.
6	OK	City of Okmulgee	11/01/01 Closed	This Order addressed discharges without a permit.
6	OK	City of Okmulgee		This Order addressed discharges without a permit.
6	OK	City of Owasso		This Order addressed bypass of untreated wastewater from manholes.
6	OK	City of Pawhuska		This Order addressed discharges without a permit.
6	OK	City of Pawhuska		This Order addressed unpermitted bypasses.
6	OK	City of Pawhuska		This Order addressed discharges without a permit.
6	OK	City of Pawnee		This Order addressed sewage bypasses.
6	OK	City of Pawnee	09/07/01 Closed	This Order addressed exceedings of discharge limits.
6	OK	City of Picher	09/15/97 Closed	This Order addressed discharges without a permit.
6	OK	City of Piedmont	10/01/95 Closed	This Order addressed discharges without a permit.
6	OK	City of Ponca	12/01/99 Closed	This Order addressed sewage treatment discharges.
6	OK	City of Poteau	10/10/95 Closed	This Order addressed discharges without a permit.
6	OK	City of Poteau	09/26/00 Closed	This Order addressed discharges without a permit.

Region	State	Case Name/City Name	Effective Date	Description
6	OK	City of Poteau	10/10/95 Closed	This Order addressed discharges without a permit.
6	OK	City of Sand Springs	05/03/01 Closed	This Order addressed unpermitted bypasses.
6	OK	City of Sand Springs	11/10/94 Closed	This Order addressed unpermitted bypasses.
6	OK	City of Sapulpa	06/20/00 Closed	This Order addressed discharges without a permit.
6	OK	City of Sapulpa	09/26/02	This Order addressed discharges without a permit. The City was required to complete construction of the collection system improvements by 04/01/03.
6	OK	City of Seminole	03/15/01 Closed	This Order addressed discharges without a permit.
6	OK	City of Seminole		This Order addressed eliminating defects contributing to bypasses.
6	OK	City of Spencer		This Order addressed discharges without a permit.
6	OK	City of Stillwater	04/12/01 Closed	This Order addressed discharges without a permit.
6	OK	City of Sulphur	10/16/00 Closed	This Order addressed discharges without a permit.
6	OK	City of Sulphur		This Order addressed discharges without a permit.
6	OK	City of Tonkawa	07/11/95 Closed	This Order addressed discharges without a permit.
6	OK	City of Valliant	10/03/97 Closed	This Order addressed discharges without a permit.
6	OK	City of Watonga		This Order addressed discharges without a permit.
6	OK	City of Waynoka	05/31/95 Closed	This Order addressed violations of discharge permit.
6	OK	City of Weleetka		This Order addressed, among other things, bypasses.
6	OK	City of Wetumka		This Order addressed discharges without a permit.
6	OK	City of Wetumka		This Order addressed discharges without a permit.
6	OK	City of Wetumka		This Order addressed discharges without a permit.
6	OK	City of Wetumka	06/21/00 Closed	This Order addressed discharges without a permit.
6	OK	City of Wetumka	10/10/95 Closed	This Order addressed violations of discharge permit.
6	OK	City of Wewoka		This Order addressed discharges without a permit.
6	OK	City of Wewoka	10/07/99 Closed	This Order addressed discharges without a permit.
6	OK	City of Wewoka		This Order addressed bypasses.
6	OK	City of Wewoka	10/07/99 Closed	This Order addressed violations of discharge.
6	OK	City of Wilburton	02/08/02; Amended 10/14/02	This Order addressed discharges without a permit. The City was required to complete the previously approved Environmental Enhancement Project (EEP) by 04/01/04, and complete construction of the approved wastewater treatment facility (WWTF) Number S-20104 and associated lift stations at Facility Numbers S-20103 and S-20105 by 11/01/04.
6	OK	City of Wilson	07/11/95 Closed	This Order addressed violations of discharge permit.
6	OK	City of Wilson	07/11/95 Closed	This Order addressed violations of discharge permit.
6	OK	City of Woodward		This Order addressed discharges without a permit.
6	OK	City of Woodward		This Order addressed discharges without a permit.

Region	State	Case Name/City Name	Effective Date	Description
6	OK	City of Woodward		This Order addressed discharges without a permit.
6	OK	City of Wynnewood	10/01/95 Closed	This Order addressed discharges without a permit.
6	OK	Delaware Public Works Authority	07/10/95 Closed	This Order addressed discharges without a permit.
6	OK	Fairfax Public Works Authority	12/20/99 Closed	This Order addressed violation of discharge permit.
6	OK	Fairfax Public Works Authority	10/10/95 Closed	This Order addressed discharges without a permit.
6	OK	Grand Lake Public Works Authority	12/01/99 Closed	This Order addressed discharges without a permit.
6	OK	Grand Lake Public Works Authority	05/26/95 Closed	This Order addressed discharges without a permit.
6	OK	Green Country Sewer Company		This Order addressed discharges without a permit.
6	OK	Haskell County Water Company	06/04/97 Closed	This Order addressed discharges without a permit.
6	OK	Haskell Public Works Authority	01/11/01 Closed	This Order addressed discharges without a permit.
6	OK	Heavener Public Works Authority	07/11/95 Closed	This Order addressed discharges without a permit.
6	OK	Helena Public Works Authority	07/11/95 Closed	This Order addressed discharges without a permit.
6	OK	Hinton Public Works Authority	04/05/94 Closed	This Order addressed lagoon sewage effluent.
6	OK	Hominy Public Works Authority	04/14/00 Closed	This Order addressed discharges without a permit.
6	OK	Hugo Municipal Authority	07/11/95 Closed	This Order addressed bypassing collection system.
6	OK	Hugo Municipal Authority	12/01/99 Closed	This Order addressed bypassing untreated sewage.
6	OK	Hugo Municipal Authority	10/01/95 Closing	This Order addressed unpermitted bypasses.
6	OK	Hulbert Public Works Authority	08/04/93 Closed	This Order addressed discharges without a permit.
6	OK	Jay Utilities Authority		This Order addressed discharges without a permit.
6	OK	Jay Utilities Authority		This Order addressed discharges without a permit.
6	OK	Jay Utilities Authority	10/10/95 Closed	This Order addressed permit violations.
6	OK	Jenks Public Works Authority		This Order addressed discharges without a permit.
6	OK	Jenks Public Works Authority	07/11/95 Closed	This Order addressed the inadequate facility to treat sewage effluent.
6	OK	Jenks Public Works Authority		This Order addressed discharges without a permit.
6	OK	Keota Public Works Authority	06/10/99 Closed	This Order addressed the inadequate facility to treat sewage effluent.
6	OK	Krebs Utilities Authority		This Order addressed discharges without a permit.
6	OK	Lakeland Water System	11/14/99 Closed	This Order addressed discharges without a permit.
6	OK	Marietta Public Works Authority	10/16/93 Closed	This Order addressed unpermitted discharges.
6	OK	Marietta Public Works Authority	10/16/93 Closed	This Order addressed discharges without a permit.
6	OK	Marietta Public Works Authority	06/19/98 Closed	This Order addressed discharge permit violations.

Region	State	Case Name/City Name	Effective Date	Description
6	OK	Muskogee Municipal Authority		This Order addressed discharges without a permit.
6	OK	Muskogee Municipal Authority	07/15/98 Closed	This Order addressed chronic bypasses.
6	OK	Muskogee Municipal Authority	07/11/95 Closed	This Order addressed the inadequate facility to treat sewage effluent.
6	OK	Ochelata Utilities Authority		This Order addressed systems overflows and bypasses.
6	OK	Okay Public Works Authority	10/06/00 Closed	This Order addressed unpermitted bypasses.
6	OK	Okemah Public Works Authority		This Order addressed discharges without a permit.
6	OK	Okemah Public Works Authority	01/26/00 Closed	This Order addressed discharges without a permit.
6	OK	Okemah Utilities Authority	07/11/95 Closed	This Order addressed unpermitted bypasses.
6	OK	Owasso Public Works Authority	10/04/01 Closed	This Order addressed discharges without a permit.
6	OK	Panama Public Works Authority		This Order addressed unpermitted bypasses.
6	OK	Pensacola Public Works Authority		This Order addressed discharges without a permit.
6	OK	Pocola Municipal Authority	08/24/99 Closed	This Order addressed unpermitted bypasses.
6	OK	Pocola Municipal Authority	10/02/02	This Order addressed discharges without a permit.
6	OK	Pocola Municipal Authority	11/22/94 Closed	This Order addressed discharges without a permit.
6	OK	Quinton Public Works Authority	07/11/95 Closed	This Order addressed the inadequate facility to treat sewage effluent.
6	OK	Regional Metropolitan Utility Authority	07/11/95 Closed	This Order addressed discharge violations.
6	OK	Ringling Municipal Authority	10/10/95 Closed	This Order addressed violations of discharge permit.
6	OK	Sapulpa Municipal Authority		This Order addressed discharges without a permit.
6	OK	Sapulpa Public Works Authority	12/21/00 Closed	This Order addressed discharges without a permit.
6	OK	Savanna Public Works Authority		This Order addressed discharges without a permit.
6	OK	Savanna Public Works Authority	10/10/95 Closed	This Order addressed bypasses/permit limits.
6	OK	Savanna Public Works Authority	12/21/00 Closed	This Order addressed discharges without a permit.
6	OK	South Coffeyville Public Works Authority		This Order addressed discharges without a permit.
6	OK	Stroud Utilities Authority	09/23/97 Closed	This Order addressed violations of discharge permit.
6	OK	Tahlequah Public Works Authority		This Order addressed discharges without a permit.
6	OK	Town + A304 of Freedom		This Order addressed unpermitted bypasses.
6	OK	Town of Achille	08/27/96 Closed	This Order addressed the Town discharging without a permit.
6	OK	Town of Alderson	12/09/98 Closed	This Order addressed the Town discharging without a permit.

Region	State	Case Name/City Name	Effective Date	Description
6	OK	Town of Alex	10/01/95 Closed	This Order addressed, among other things, the Town discharging without a permit.
6	OK	Town of Antlers	09/20/95 Closed	This Order addressed bypasses/discharges without a permit.
6	OK	Town of Antlers	12/01/99 Closed	This Order addressed bypass and discharge violations.
6	OK	Town of Antlers		This Order addressed unpermitted bypasses.
6	OK	Town of Antlers		This Order addressed unpermitted bypasses.
6	OK	Town of Antlers	03/10/00 Closed	This Order addressed unpermitted bypasses.
6	OK	Town of Arapaho	09/14/00 Closed	This Order addressed discharges without a permit.
6	OK	Town of Arkoma		This Order addressed discharges without a permit.
6	OK	Town of Atoka	08/15/00 Closed	This Order addressed discharges without a permit.
6	OK	Town of Blair	10/23/96 Closed	This Order addressed discharges without a permit.
6	OK	Town of Bokoshe		This Order addressed discharges without a permit.
6	OK	Town of Boswell	11/22/94 Closed	This Order addressed discharges without a permit.
6	OK	Town of Boynton	04/20/95 Closed	This Order addressed unpermitted bypasses.
6	OK	Town of Caddo		This Order addressed discharges without a permit.
6	OK	Town of Canute	06/23/99 Closed	This Order addressed discharges without a permit.
6	OK	Town of Canute		This Order addressed discharges without a permit.
6	OK	Town of Chelsea		This Order addressed discharges without a permit.
6	OK	Town of Cimarron City	07/27/99 Closed	This Order addressed discharges without a permit.
6	OK	Town of Copan	07/10/95 Closed	This Order addressed discharges without a permit.
6	OK	Town of Covington	10/10/01 Closed	This Order addressed discharges without a permit.
6	OK	Town of Crescent	05/18/95 Closed	This Order addressed violation of discharge permit.
6	OK	Town of Dacoma		This Order addressed unpermitted bypasses.
6	OK	Town of Davenport	07/18/94 Closed	This Order addressed discharges without a permit.
6	OK	Town of Deer Creek	07/10/95 Closed	This Order addressed discharge permit violations.
6	OK	Town of Deer Creek	07/10/95 Closed	This Order addressed discharges without a permit.
6	OK	Town of Devol	11/07/00 Closed	This Order addressed discharges without a permit.
6	OK	Town of Dill City	08/17/01 Closed	This Order addressed discharges without a permit.
6	OK	Town of Dougherty	10/01/95 Closed	This Order addressed discharges without a permit.
6	OK	Town of Dougherty		This Order addressed discharges without a permit.
6	OK	Town of East Duke	12/01/99 Closed	This Order addressed discharges without a permit.
6	OK	Town of Fairmont	10/10/95 Closed	This Order addressed violation of discharge permit.
6	OK	Town of Fargo	10/03/95 Closed	This Order addressed discharges without a permit.

Region	State	Case Name/City Name	Effective Date	Description
6	OK	Town of Freedom	09/17/99 Closed	This Order addressed discharges without a permit.
6	OK	Town of Freedom	07/10/95 Closed	This Order addressed discharges without a permit.
6	OK	Town of Ft. Towson	12/01/99 Closed	This Order addressed discharges without a permit.
6	OK	Town of Gans	05/30/00 Closed	This Order addressed discharges without a permit.
6	OK	Town of Garvin	10/13/99 Closed	This Order addressed discharges without a permit.
6	OK	Town of Geronimo	12/01/99 Closed	This Order addressed discharges without a permit.
6	OK	Town of Gore		This Order addressed unpermitted bypasses.
6	OK	Town of Inola		This Order addressed discharges without a permit.
6	OK	Town of Jennings	07/11/95 Closed	This Order addressed the exceeding discharge limits.
6	OK	Town of Jet	09/14/92 Closed	This Order addressed violation of discharge permit.
6	OK	Town of Keota	01/18/00 Closed	This Order addressed discharges without a permit.
6	OK	Town of Kingston	10/06/94 Closed	This Order addressed bypasses and discharges without a permit.
6	OK	Town of Kingston	10/06/94 Closed	This Order addressed discharges without a permit.
6	OK	Town of Kiowa		This Order addressed discharges without a permit.
6	OK	Town of Krebs	09/12/97 Closed	This Order addressed discharges without a permit.
6	OK	Town of Kremlin	09/04/01 Closed	This Order addressed discharges without a permit.
6	OK	Town of Lamont		This Order addressed unpermitted bypasses.
6	OK	Town of Langston	01/09/03	This Order addressed discharges without a permit. The City was required to complete construction of the upgrades to the wastewater treatment plant within 14 months from the start of construction.
6	OK	Town of Lone Wolf	12/01/99 Closed	This Order addressed discharges without a permit.
6	OK	Town of Mannford		This Order addressed discharges without a permit.
6	OK	Town of Maud		This Order addressed discharges without a permit.
6	OK	Town of Meeker	04/11/95 Closed	This Order addressed bypassing.
6	OK	Town of Meeker	04/10/92 Closed	This Order addressed the inadequate facility to treat sewage effluent.
6	OK	Town of Muldrow	06/06/97 Closed	This Order addressed discharges without a permit.
6	OK	Town of Muldrow		This Order addressed discharges without a permit.
6	OK	Town of Nash		This Order addressed discharges without a permit.
6	OK	Town of Okarche	04/04/00 Closed	This Order addressed discharges without a permit.
6	OK	Town of Okarche		This Order addressed discharges without a permit.
6	OK	Town of Oktaha		This Order addressed plant overload, no operator, and discharges.
6	OK	Town of Panama	07/11/95 Closed	This Order addressed discharges without a permit.
6	OK	Town of Panama	07/11/95 Closed	This Order addressed discharges without a permit.
6	OK	Town of Panama	07/11/95 Closed	This Order addressed violations of discharge permit.

Region	State	Case Name/City Name	Effective Date	Description
6	OK	Town of Pond Creek	09/12/95 Closed	This Order addressed violations of discharge permit.
6	OK	Town of Quinton	09/14/99 Closed	This Order addressed discharges without a permit.
6	OK	Town of Quinton		This Order addressed discharges without a permit.
6	OK	Town of Ralston	06/11/96 Closed	This Order addressed discharges without a permit.
6	OK	Town of Ratliff City	12/05/00 Closed	This Order addressed discharges without a permit.
6	OK	Town of Salina	10/20/99 Closed	This Order addressed discharges without a permit.
6	OK	Town of Salina	11/21/01 Closed	This Order addressed unpermitted bypasses.
6	OK	Town of Salina		This Order addressed discharges without a permit.
6	OK	Town of Skiatook	07/11/95 Closed	This Order addressed discharges without a permit.
6	OK	Town of Soper	12/01/99 Closed	This Order addressed discharges without a permit.
6	OK	Town of Soper	10/10/95 Closed	This Order addressed discharges without a permit.
6	OK	Town of Soper		This Order addressed discharges without a permit.
6	OK	Town of Soper	08/10/01 Closed	This Order addressed discharges without a permit.
6	OK	Town of Spiro	07/06/00 Closed	This Order addressed discharges without a permit.
6	OK	Town of Spiro		This Order addressed discharges without a permit.
6	OK	Town of Springer	11/25/96 Closed	This Order addressed discharges without a permit.
6	OK	Town of Temple	02/22/00 Closed	This Order addressed discharges without a permit.
6	OK	Town of Tipton	12/01/99 Closed	This Order addressed discharges without a permit.
6	OK	Town of Tryon	03/11/97 Closed	This Order addressed discharges without a permit.
6	OK	Town of Wakita	09/19/94 Closed	This Order addressed discharges without a permit.
6	OK	Town of Wanette		This Order addressed discharges without a permit.
6	OK	Town of Wanette	01/12/01 Closed	This Order addressed discharges without a permit.
6	OK	Town of Wanette	12/01/99 Closed	This Order addressed discharges without a permit.
6	OK	Town of Washington	10/10/95 Closed	This Order addressed discharges without a permit.
6	OK	Town of Wayne	12/09/98 Closed	This Order addressed discharges without a permit.
6	OK	Town of Wayne	10/10/95 Closed	This Order addressed discharges without a permit.
6	OK	Town of Wayne		This Order addressed violations of discharge permit.
6	OK	Town of Wellston	03/15/94 Closed	This Order addressed the inadequate facility to treat sewage effluent.
6	OK	Town of Wellston	03/15/94 Closed	This Order addressed violations of discharge permit.
6	OK	Town of Wister	02/01/87 Closed	This Order addressed bypass of raw sewage.

Region	State	Case Name/City Name	Effective Date	Description
6	OK	Town of Wister	07/06/00 Closed	This Order addressed discharges without a permit.
6	OK	Town of Wright City	01/08/02 Closed	This Order addressed discharges without a permit.
6	OK	Tulsa Metropolitan Utility Authority	08/20/91 Closed	This Order addressed discharges without a permit.
6	OK	Tulsa Metropolitan Utility Authority		This Order addressed discharges without a permit.
6	OK	Tulsa Metropolitan Utility Authority	08/08/98 Closed	This Order addressed discharges without a permit.
6	OK	Valliant Public Works Authority	07/19/96 Closed	This Order addressed violations of discharge permit.
6	OK	Wagoner Public Works Authority		This Order addressed discharges without a permit.
6	OK	Wagoner Public Works Authority	06/04/93 Closed	This Order addressed infiltration problems and bypasses.
6	OK	Warner Utilities Authority		This Order addressed discharges without a permit.
6	OK	Warner Utilities Authority		This Order addressed discharges without a permit.
6	OK	Warr Acres Public Works Authority	07/01/93 Closed	This Order addressed discharges without a permit.
6	OK	Warr Acres Public Works Authority	07/01/93 Closed	This Order addressed discharges without a permit.
6	OK	Weleetka Public Works Authority, City of Weleetka	10/14/02	This Order addressed discharges without a permit. The City was required to complete construction of the collection system improvements by 12/01/03.
6	OK	Wilburton Public Works Authority	10/10/95 Closed	This Order addressed violations of discharge permit.
6	OK	Wright City Public Works Authority	10/01/95 Closed	This Order addressed violations of discharge permit.
6	OK	Wright City Public Works Authority	01/25/99 Closed	This Order addressed violations of discharge permit.
9	CA	City of Chico, Central Valley Region	2000	The Order required the City to submit a detailed workplan and timeline which were supposed to include dates for submission of progress reports and for completion of the Supplemental Environmental Project (SEP). A \$50,000 civil liability penalty was assessed.
9	CA	City of Crescent City, North Coast Region	2000	This Order established a schedule for the City to complete the long-term planning process to provide adequate wastewater treatment capacity.
9	CA	City of Folsom, Central Valley Region	2000	This Order addressed discharges of pollutants without waste discharge requirements. A civil liability penalty of \$70,000 was proposed.
9	CA	City of Los Angeles, Los Angeles Region	2000	This Order required the City to upgrade sewers in the Hyperion service area, such upgrades included: implement the corrective measures for Boyle Heights and Silver Lake, construct the North Hollywood Interceptor Sewer, the North Outfall Relief Sewer (NOS)-East Central Interceptor Sewer (ECIS), the Northeast Interceptor Sewer (NEIS) - Eagle Rock Blvd. to Mission Rd., and the Eagle Rock Area Relief Sewer Phases 2B, 2C, and 2D. Additionally, the City was required to reduce the risk of SSOs by bypassing filtration processes at the Tillman and LA/Glendale Plants under specified conditions until completion of the ECIS and NEIS projects.

Region	State	Case Name/City Name	Effective Date	Description
9	CA	City of Pacifica, Calera Creek Water Recycling Plant		This Order required the City to either pay a civil liability in the amount of \$125,033 or, pay a \$10,000 and complete a SEP in the amount of \$115,033.
9	CA	Coachella Valley Water District, Colorado River Basin Region	2001	This Order addressed the discharge of untreated wastewater to the Coachella Branch of the All American Canal and Lake Calhoun.
9	CA	Fort Bragg Municipal Improvement District No. 1, WWTF	03/22/01	This was a Cease and Desist Order which modified the time schedule of a previous Order to reflect a nine month delay in the NPDES permit renewal.
9	CA	Fort Bragg Municipal Improvement District No. 1, WWTF	03/28/02	This Order addressed their request to adjust the 2001 time schedule to reflect delay in permit renewal, with the exception of those tasks already completed.
9	CA	Long Beach Water Reclamation Plant, Long Beach	07/11/02	The Order required them to complete construction of the modified process for nitrification and de-nitrification, submit a pollution prevention plan (PPP) workplan with a time schedule for implementation of the construction, achieve compliance with its permit, and submit quarterly progress reports.
9	CA	Los Coyotes Water Reclamation Plant, Cerritos	07/11/02	The Order required them to complete construction of the modified process for nitrification and de-nitrification, submit a PPP workplan with a time schedule for implementation of the construction, achieve compliance with its permit, and submit quarterly progress reports.
9	CA	Orange County Sanitation District (OCSD), Fountain Valley		This Order addressed the release and spill of approximately 122,000 gallons of sewage. An estimated 20,000 gallons was recovered and an estimated 102,000 gallons entered Newport Bay. As a result of this spill a precautionary beach closure for all beaches within the western half of Newport Bay was issued for six days.
9	CA	Orange County Sanitation District (OCSD), Fountain Valley	10/12/00	This Order addressed an estimated 60,600 gallons of sewage overflowing from a manhole in Beach Blvd., approximately 200 feet south of Imperial Highway. As a result, sewage flowed approximately 1,000 feet to a storm drain drop inlet and eventually entered Coyote Creek. An estimated 1,000 gallons of sewage was recovered, and approximately 59,600 gallons were not recovered.
9	CA	Sonoma County Sanitation District, City of Sonoma	05/23/01	Two Administrative Orders were issued addressing violations of its NPDES permit limits during two separate periods. Action was taken to address their pollution prevention/ source reduction and pretreatment programs not being managed adequately or implemented aggressively enough.
9	CA	Sonoma County Sanitation District, City of Sonoma	04/01/02	This Order required them to cease and desist from discharging wastes in violation of its NPDES permit and, they were required to continue and expand its current "Zinc Source Identification and Reduction Study." The Order also indicated that if they were successful in identifying the sources of zinc in its effluent, then a workplan identifying all necessary courses of actions to reduce the zinc in its treatment plant influent and effluent.

Region	State	Case Name/City Name	Effective Date	Description
9	CA	Whittier Narrows Water Reclamation Plant, El Monte	08/29/02	The Order required them to complete construction of the modified process for nitrification and de-nitrification, submit a PPP workplan with a time schedule for implementation of the construction, achieve compliance with its permit, and submit quarterly progress reports.
9	CA	Yucaipa Valley Water District, Yucaipa	01/24/03	This Order addressed 28 effluent limit violations and a penalty of \$84,000 was assessed. They agreed to perform a SEP that would benefit the Upper Santa Ana Watershed, contributing \$49,500 towards the cleanup of the perchlorate contamination in the Colton-Rialto area.
10	OR	City of Albany	05/16/01	The City was required to complete construction and attain operational level of the Maple Street pump station and force main upgrades by 10/31/02, and complete construction and attain operational level of the approved treatment facility improvements by 12/31/09. A \$107,5000 civil liability was imposed.
10	OR	City of Amity	03/01/00	Under this Order, the City was required to submit construction plans and specifications for upgrading the drinking water system and complete the necessary upgrades or improvements within 22 months of this Order. They were also required to submit a Reclaimed Water Use Plan outlining the minimum rule requirements for how the City will achieve compliance and a final Phase I and Phase II construction plans and specifications for completing improvements to the WWTP.
10	OR	City of Amity	Amendment 04/12/00	This amendment to the March 2000 Order approved the City's request for an extension to one compliance date requiring the City to submit a Reclaimed Water Use Plan by 10/01/00.
10	OR	City of Amity	Amendment 11/02/00	This amendment to the March 2000 Order approved the City's request for an extension to one compliance date requiring the City to submit a Reclaimed Water Use Plan by 02/01/01.
10	OR	City of Amity	Amendment 03/28/02	This amendment required them to, among other things, complete all necessary upgrades to the drinking water system by 09/01/02. Additionally, by 05/20/02, they were required to submit engineering plans and specifications for the entire wastewater improvement project and by 10/01/03, complete the upgrades to the wastewater treatment facilities.
10	OR	City of Amity	Amendment 05/17/02	This amendment approved the request for an extension to the engineering plans and specifications from 05/20/02 to 07/30/02.
10	OR	City of Ashland	02/06/95	This Order required the City to submit to the Department for approval a complete facilities plan by 10/95.
10	OR	City of Brookings	04/16/92	Under this Order, the City was required to complete construction on the facultative sludge lagoon(s) and associated structures by 11/01/93, and complete construction on the Wastewater Treatment Plant Improvement Project by 12/01/94.

Region	State	Case Name/City Name	Effective Date	Description
10	OR	City of Coos Bay, WWTF #1	08/21/03	This Order addressed the prevention of future waste discharge violations. The Order required that within 12 months of approval of the final engineering Plans and Specifications, the City will complete construction of the wastewater control facilities.
10	OR	City of Coos Bay, WWTF #2	08/21/03	This Order required that within two years after award of a contract for construction, the City will complete construction of the approved wastewater control facilities and initiate operations.
10	OR	City of Falls City, OR	04/04/00	This Order required that within six months following the Department's approval of the Final Plans and Specifications, the City will complete the removal of the Fair Oaks Pump Station and replace it with a gravity line. They were also required to complete the necessary optimization/upgrades to the WWTF.
10	OR	City of Garibaldi	10/01/02	The Order required the City to complete the upgrades/expansion to the WWTFs as specified in the approved engineering Plans and Specifications and comply with all permit requirements, State, and Federal regulations and water quality standards by 05/31/04.
10	OR	City of Glendale	11/03/98	This Order required the City to complete the necessary upgrades or improvements to the drinking water system and achieve compliance with all applicable drinking water requirements by 09/30/01, complete the removal of inflow sources identified and prioritized in the Inflow Evaluation and Reduction Report for the WWTFs by 10/01/00, and complete the necessary upgrades/expansion to the WWTFs and comply with all permit requirements, State, and Federal regulations and water quality standards by 12/31/03.
10	OR	City of Grants Pass	10/24/01	The Order required that within two years of Department approval of diffuser Plans and Specifications, the City will complete construction of the effluent diffuser.
10	OR	City of Lowell, OR	11/08/01	This Order required that within 18 months after award of the construction contract, the City will complete construction upgrades/expansions required by the approved engineering Plans and Specifications.
10	OR	City of McMinnville	04/05/93	The Order required the City to upgrade and repair its sewage collection system pursuant to the approved overall I/I Correction Plan by 10/31/99.
10	OR	City of Medford	12/27/02	This Order required the City to complete construction of Phase I of the City's Best Management Practices (BMPs) by 06/02/03, and complete construction of Phase II of the City's BMPs by 03/01/04.
10	OR	City of Monroe	11/03/98	This Order required the City to complete the necessary upgrades or improvements to the drinking water system by 01/02/01, install and operate an influent flow meter at the treatment plant site by 10/31/98, complete the removal of all inflow sources identified in the approved Pre-Design Report by 11/01/03, and complete the necessary upgrades/expansion to the WWTFs by 11/01/06.

Region	State	Case Name/City Name	Effective Date	Description
10	OR	City of Myrtle Creek	05/30/02	This Order required the City to have wastewater control facilities in operation to comply with water quality standards immediately upon approval of Plans and Specifications and have the WWTF will be constructed and operational by 12/31/04.
10	OR	City of Powers	12/29/00	This Order required the City to complete Phase I by 10/01/03, and no later than the same time as completion of Phase I, the City will complete monitoring of flows in the collection lines, complete Phase II by 10/01/02, and complete all upgrades to the WWTP and comply with all NPDES permit conditions by 10/01/05.
10	OR	City of Rainier	12/15/95	The City was required to complete the upgrades to the drinking water treatment facility within 15 months following approval of the Plans and Specifications. Additionally, they were required to complete Phase I of the interim improvements to the WWTF by 01/02/96, complete Phase II of the interim improvements to the WWTF by 01/02/97, and complete the decommissioning of the underground storage tanks (USTs) within four months of approval of the decommissioning plan.
10	OR	City of Salem	01/21/98	This Order required the City to complete construction and initiated operation of the approved facilities and complete construction for all projects identified in the Salem Master Plan for the purposes of eliminating overflows to tributary streams by 01/01/00, and eliminate all SSOs by 12/31/09.
10	OR	City of Sweet Home	01/19/99	This Order required the City to complete the removal of all reasonably removable inflow sources into the City's wastewater collection system by 01/15/00. Within two years after award of construction contracts, the City will complete construction of the wastewater improvements.
10	OR	City of Sweet Home	Modification 1/19/01	This Order required the City to submit a draft facility plan and time schedule that evaluates alternatives for either increasing treatment capacity or reducing raw sewage flows down to the current treatment capacity by 10/31/05.
10	OR	City of Sweet Home	05/09/01	This was a modification approving the City's request to extend the compliance deadlines.
10	OR	City of Tillamook	01/06/03	This Order required the City to complete construction of a new digester supernatant pump station and modifications and repairs for the RBCs as required in the approved Plans and Specifications for the expanded Corrective Action Plan by 05/01/03. Additionally, the City was required to complete construction of the modifications to the facilities and repairs to the wastewater treatment facilities as required by the approved plans and specifications for the expanded Corrective Action Plan by 07/31/03.
10	OR	City of Toledo	11/15/00	This Order required that within 24 months after award of the construction contract, the City will complete construction of the necessary improvements.
10	OR	City of Warrenton	12/24/01	This Order required that within 15 months of awarding contracts for construction, the construction of the approved Plans and Specifications will be complete.

Region	State	Case Name/City Name	Effective Date	Description
10	OR	City of Willamina	09/26/96	This Order required that within 12 months following the award of the construction contract, the City will complete construction of the necessary Phase I and Phase II improvements. By 07/01/03, the City will complete inflow corrective work.
10	OR	Clackamas County Service District #1, Oregon City	01/13/94	The Order required the County to have their wastewater control facilities in compliance with the water quality standards for chlorine by 12/31/94.
10	OR	Oak Lodge Sanitary District, Clackamas County	05/17/95	This Order required the District to have wastewater control facilities in operation to comply with the water quality standards for chlorine by 12/31/98.
10	OR	Roseburg Urban Sanitary Authority, Douglas County	06/27/94	This Order required the Authority to complete construction and installation of the back-up power generators at the Goedeck Waste Water Treatment Plant by 02/15/95.
10	OR	Roseburg Urban Sanitary Authority, Douglas County	09/30/92	This Order required that within eighteen months after approval of the engineering Plans and Specifications, the City will complete construction of the necessary improvements.
10	OR	Tri-City Service District, Clackamas	02/28/94	This Order required the District to complete the planning, designing, financing, and construction to increase the pump station capacity to accommodate a one in five year event and thereby substantially relieve bypass/overflows from certain discharge points by 07/01/97.
FL	FL	City of St. Petersburg	02/04/00	The Order required the City to budget appropriate monies, implement, and complete the recommendations for improvements to the Facilities and Systems established in the Final Report. They were also required to immediately initiate the capital improvements set forth in the Order, which were expected to be complete within seven years. In lieu of a \$391,533 civil penalty, they elected to implement several in-kind penalty projects.

K.11 State CSO Administrative Penalty Orders

Region	State	Case Name/City Name	Effective Date	Penalty Amount
1	ME	City of Bath	01/09/92	\$14,000
1	ME	City of Biddeford	07/22/91	\$24,000
1	ME	City of Brewer	02/27/92	\$75,000
1	ME	Town of Lisbon	05/24/90	\$10,400
2	NJ	Camden County Municipal Utilities Authority	07/11/98	\$1,886
2	NJ	City of Camden	08/23/99	\$17,680
2	NJ	City of Gloucester	07/22/99	\$9,875
2	NJ	City of Newark	05/09/01	\$30,709
2	NJ	City of Paterson	02/01/99	\$15,000
2	NJ	City of Rahway	05/08/00	\$8,953
2	NJ	Middlesex County Utilities Authority	04/13/95	\$336,750
2	NJ	Middlesex County Utilities Authority (MCUA)	06/05/96	\$54,000
4	TN	Metropolitan Government of Nashville and Davidson County	09/17/99	\$600,000
5	IN	Bluffton POTW	06/06/03	\$60,000
5	IN	City of Sullivan	01/22/03	\$575
5	IN	Town of Remington	06/06/03	\$825
5	IN	Town of Ridgeville	10/15/01	\$750
5	IN	Town of Sullivan	01/22/03	\$2,625

K.12 State SSO Administrative Penalty Orders

Region	State	Case Name/City Name	Effective Date	Penalty Amount
4	AL	Demopolis Water Works and Sewer Board, City of Demopolis	08/02/01	\$5,300
4	AL	Stevenson Utilities Board, Stevenson Wastewater Treatment Lagoon, Stevenson	01/09/02	\$1,300
4	NC	Belmont City-A Sludge/Lars	10/30/01	\$4,234
4	NC	Mebane Bridge WWTP	01/25/02	\$1,774
4	NC	Morrisville Town-Carpenter Plant	04/11/00	\$7,421
4	NC	Murfreesboro Town-WWTP	10/11/00	\$4,240
4	NC	Neuse Crossing WWTP	02/17/00	\$10,801
4	NC	Pond Creek WWTP	01/25/02	\$4,100
4	NC	Sanford WWTP	11/25/02	\$18,214
4	NC	Sanford WWTP	07/09/03	\$19,423
4	NC	Town of Canton	03/27/00	\$21,742
4	NC	Town of Green Level	03/16/01	\$5,862
4	NC	Warsaw WWTP	08/03/00	\$12,517
4	NC	Wrenn Road Spray Irrigation Facility	03/16/01	\$7,295
4	TN	City of Alexandria	10/02/02	\$104,000
4	TN	City of Bluff City	07/25/98	\$17,750
4	TN	City of Church Hill	04/02/97	\$5,000
4	TN	City of East Ridge	04/29/96	\$30,000
4	TN	City of Franklin	10/26/99	\$6,326 - Damage Fee; \$3,750 - Civil Penalty
4	TN	City of Franklin	11/13/00	\$78,295 - Damage Fee; \$57,500 Civil Penalty
4	TN	City of Greenbrier	03/20/00	\$141,750
4	TN	City of Harriman	06/28/00	\$266,250
4	TN	City of Harriman	07/23/02	\$30,000
4	TN	City of Jellico	10/03/97	\$11,500
4	TN	City of Kingston	11/30/01	\$207,000
4	TN	City of Lafayette	04/22/03	\$92,500
4	TN	City of LaVergne	11/08/99	\$2,500
4	TN	City of LaVergne	10/24/00	\$2,000
4	TN	City of Lawrenceburg	03/27/01	\$9,375
4	TN	City of Middleton	08/25/00	\$47,750
4	TN	City of Murfreesboro	08/21/99	\$400,000
4	TN	City of Murfreesboro	05/22/01	In lieu of paying the \$50,000 civil penalty, the City agreed to perform a Supplemental Environmental Project (SEP). The City was supposed to purchase a five-acre lot which had a wetland.
4	TN	City of Portland Public Works	08/02/02	\$541 - Damage Fee; \$5,000 - Penalty Fee
4	TN	City of Red Bank	02/25/97	\$164,500
4	TN	City of Rockwood	10/29/98	\$16,750
4	TN	City of Sparta	10/04/00	\$62,000
4	TN	City of Watertown	02/08/00	\$1,100
4	TN	City of Watertown	06/03/03	\$87,500

Region	State	Case Name/City Name	Effective Date	Penalty Amount
4	TN	Knoxville Utilities Board	05/20/03	\$475,000
4	TN	Lynnwood Utility Corporation		\$5,000
4	TN	Metropolitan Government of Nashville and Davidson County	09/17/99	Of the total \$600,000 penalty, \$100,000 was due within one month of this Order. However, in lieu of the \$100,000, they agreed to perform a SEP.
4	TN	Town of Collierville	06/03/98	\$118,500
4	TN	Town of Gainesboro	11/22/00	\$67,625
4	TN	Town of Gainesboro	03/27/01	\$5,500
4	TN	Town of Monterey	09/11/02	\$115,500
4	TN	Town of Mosheim	04/25/01	\$3,000
4	TN	Town of Pikeville	01/09/00	\$58,250
4	TN	Town of Spring City	07/31/03	\$15,000
4	TN	Town of Spring Hill	01/26/00	\$73,312
6	OK	City of Holdenville	11/07/02	\$5,000
9	CA	California Department of Corrections, Sierra Conservation Center WTF, Tuolumne County	06/01/01	\$96,000
9	CA	California Department of Parks and Recreation, Angel Island State Park		\$33,000
9	CA	California Department of Parks and Recreation, Big Basin Redwoods State Park WWTP	09/20/02	\$135,000
9	CA	California Men's Colony San Luis Obispo County and Indirect Dischargers and Local Sewering Entities of Camp San Luis Obispo, Cuesta College, San Luis Obispo County Educational Center, and San Luis Obispo County Operational Facility	10/26/01	\$87,000
9	CA	Carpinteria Sanitary District, Santa Barbara County	04/09/01	\$6,000
9	CA	Cedars-Sinai Medical Center, Imaging Building	09/27/02	\$3,000
9	CA	Centinela State Prison WWTF, Imperial County	04/30/01	\$33,000
9	CA	Centinela State Prison WWTF, Imperial County	2000	\$9,000
9	CA	Central Marin Sanitation Agency, San Rafael, Marin County		\$15,000
9	CA	Central Marin Sanitation District, San Rafael, Marin County	2001	\$6,000
9	CA	Cities of South San Francisco and San Bruno Water Quality Control Plant	07/16/03	\$81,000
9	CA	City and County of San Francisco, Southeast Water Pollution Control Plant		\$3,000

Region	State	Case Name/City Name	Effective Date	Penalty Amount
9	CA	City of Anderson Water Pollution Control Plant, Shasta County		\$3,000
9	CA	City of Anderson Water Pollution Control Plant, Shasta County		\$10,000
9	CA	City of Anderson Water Pollution Control Plant, Shasta County	2000	\$3,000
9	CA	City of Anderson Water Pollution Control Plant, Shasta County		\$10,000
9	CA	City of Atwater WWTF, Merced County	2000	\$36,000
9	CA	City of Atwater WWTF, Merced County	04/27/01	\$30,000
9	CA	City of Benicia WWTP, Solano County	2000	\$3,000
9	CA	City of Benicia WWTP, Solano County	2000	\$9,000
9	CA	City of Benicia WWTP, Solano County	10/29/2001	\$18,000
9	CA	City of Brawley WWTF, Imperial County	03/15/02	\$33,000
9	CA	City of Brawley WWTF, Imperial County	2001	\$6,000
9	CA	City of Brawley WWTF, Imperial County	2000	\$3,000
9	CA	City of Brentwood WWTP, Contra Costa County	07/26/01	\$243,000
9	CA	City of Burlingame, San Mateo County	12/21/01	\$3,000
9	CA	City of Chico WWTF, Butte County	01/29/00	\$6,000
9	CA	City of Chico WWTF, Butte County		\$100,000
9	CA	City of Corona	2000	\$15,000
9	CA	City of Corona	2001	\$288,000
9	CA	City of Coronado, Glorietta Bay Pump Station Construction Dewatering	10/09/02	\$39,000
9	CA	City of El Centro WWTP		\$15,000
9	CA	City of Escondido Hale Avenue Resource Recovery Facility, San Diego County	07/27/00	\$3,000
9	CA	City of Escondido, San Diego County	09/29/00	\$6,000
9	CA	City of Lakewood, Department of Water Resources	05/09/02	\$3,000
9	CA	City of Livermore, Alameda County		\$15,000
9	CA	City of Morro Bay and Cayucos Sanitary District WWTP, San Luis Obispo County	10/07/03	\$12,000
9	CA	City of Palo Alto, Santa Clara County		\$12,000
9	CA	City of Pasadena Department of Water and Power (Power Plant)	08/19/02	\$6,000
9	CA	City of Petaluma, Sonoma County	02/01/02	\$30,000
9	CA	City of Redondo Beach, Seaside Lagoon	03/29/02	\$51,000
9	CA	City of Rialto	08/02/02	\$30,000
9	CA	City of Rio Vista Trilogy WWTF, Solano County	07/10/02	\$3,000
9	CA	City of Rio Vista WWTF, Solano County	07/10/02	\$6,000
9	CA	City of San Diego, San Diego Convention Center Dewatering	04/25/02	\$81,000
9	CA	City of San Mateo Wastewater Treatment Plant, San Mateo County	01/24/03	\$39,000
9	CA	City of Santa Cruz	07/30/02	\$40,000
9	CA	City of Santa Rosa, Laguna Subregional WWT, Reuse, and Disposal Facilities	04/30/02	\$15,000

Region	State	Case Name/City Name	Effective Date	Penalty Amount
9	CA	City of Santa Rosa, Subregional Wastewater Treatment, Reuse and Disposal Facilities	05/02/02	\$12,350
9	CA	City of Vacaville WWTP, Solano County	07/10/02	\$27,000
9	CA	Coachella Sanitary District WWTF Coachella, Riverside County		\$45,000
9	CA	Coachella Sanitary District WWTF, Riverside County	04/30/01	\$27,000
9	CA	Coachella Sanitary District WWTF, Riverside County	04/30/01	\$3,000
9	CA	Coachella Sanitary District WWTF, Riverside County	2001	\$51,000
9	CA	Coachella Sanitary District, Owner/Operator Coachella Sanitary District WWTF Coachella, Riverside County	03/15/02	\$24,000
9	CA	Coachella Valley Water District WWTP		\$20,000
9	CA	Colton/San Bernardino Regional Tertiary Treatment and Water Reclamation Authority	08/02/02	\$54,000
9	CA	County of Los Angeles Department of Parks and Recreation, Val Verde County Park Swimming Pool	09/23/02	\$21,000
9	CA	County of Los Angeles Department of Public Works Alamitos Barrier Project (San Gabriel River), Long Beach	09/27/02	\$24,000
9	CA	County of Los Angeles Department of Public Works Storm Drain Project 9037	12/05/02	\$6,000
9	CA	Department of Public Works City of Los Angeles, Marina Interceptor Sewer	09/27/02	\$51,000
9	CA	East Bay Municipal Utility District, Orinda WTP, Contra Costa County		\$9,000
9	CA	East Bay Municipal Utility District, Orinda WTP, Contra Costa County		\$25,000
9	CA	Eastern Municipal Water District	06/22/00	\$10,000
9	CA	Fairfield Suisun Sanitary District, Solano County		\$9,000
9	CA	Fallbrook Public Utility District	12/11/02	\$87,000
9	CA	Fallbrook Public Utility District WWTP No.1, San Diego	10/24/02	\$87,000
9	CA	Harris Water Conditioning, Inc., Culligan Soft Water	02/07/02	\$9,000
9	CA	Las Virgenes Municipal Water District, Tapia Water Reclamation Plant, Calabasas	03/27/02	\$12,000
9	CA	Mt. View Sanitary District, Contra Costa County		\$3,000
9	CA	Napa Sanitation District, Napa County		\$153,000
9	CA	Natural History Museum of Los Angeles County	08/19/02	\$3,000

Region	State	Case Name/City Name	Effective Date	Penalty Amount
9	CA	Rancho California Water District, Santa Rosa Water Reclamation Facility, Riverside County	03/13/02	\$66,000
9	CA	Rancho California Water District, Well No. 121	12/11/02	\$3,000
9	CA	Rodeo Sanitary District, Contra Costa County		\$33,000
9	CA	San Francisco International Airport, Water Quality Control Plant		\$27,000
9	CA	Sewerage Agency of Southern Martin, Mill Valley, Marin County		\$6,000
9	CA	Southern California Water Company, Yukon Plant	01/11/02	\$21,000
9	CA	State of California Department of Corrections, Centinela State Prison WWTF, Imperial County		\$6,000
9	CA	The City of Chico WWTF, Butte County		\$9,000
9	CA	The City of Santa Cruz	09/20/02	\$40,000
9	CA	University of California at Los Angeles	03/06/01	\$6,000
9	CA	West County Wastewater District, Contra Costa County		\$192,000
9	CA	Western Riverside County Regional Wastewater Authority	01/18/02	\$96,000
9	CA	Yucaipa Valley Water District		\$39,000
9	CA	Yucaipa Valley Water District		\$48,000
10	OR	City of Albany	05/16/01	\$5,080

Appendix L

Technology Descriptions

L.1 Operation and Maintenance Practices

Sewer Testing and Inspection Techniques
Sewer Cleaning Techniques
Pollution Prevention
Monitoring, Reporting, and Public Notification

L.2 Collection System Controls

Maximizing Flow to Treatment Plant
Monitoring & Real-Time Control
Inflow Reduction
Sewer Separation
Sewer Rehabilitation
Service Lateral Rehabilitation
Manhole Rehabilitation

L.3 Storage Facilities

In-line Storage
Off-line Storage
On-site Storage

L.4 Treatment Technologies

Supplemental Treatment
Plant Modifications
Disinfection
Vortex Separators
Floatables Control

L.5 Low-Impact Development Techniques

Porous Pavement
Green Roofs
Bioretention
Water Conservation



TECHNOLOGY DESCRIPTION

OPERATION & MAINTENANCE

Sewer Testing and Inspection Techniques

Overview

Operations and maintenance practices, such as sewer testing and inspection, enhance sewer system performance. Specifically, testing and inspection practices ensure that new connections are made correctly, help locate and protect against unwanted inflow and infiltration (I/I), and assess the structural condition of the sewer system. Inspection techniques can also be useful in identifying locations where grease and debris accumulate or where roots intrude into the sewer, which can cause sewer blockages resulting in unexpected CSOs and SSOs. The keys to a successful sewer testing and inspection program are identification of potential or current problem locations; correction of the problem; and evaluation of the effectiveness of the corrective measures.

Sewer Testing Techniques

In general, sewer testing techniques are used to identify leaks which allow unwanted infiltration into the sewer system and determine the location of illicit connections and other sources of storm water inflow. Air testing and hydrostatic testing are used to identify leaks in the sewer system. Smoke testing is used to determine connectivity and to identify points where inflow to the sewer system can occur. These testing techniques are described in further detail below.

Air Testing

Air testing is used to determine if a particular section of sewer line has leaks that would allow unwanted groundwater to infiltrate into the system or sewage to exfiltrate into the surrounding soil. Plugs, such as inflatable stoppers, are placed at either end of the test section, and in all service connections to the section. The test section is pressurized with air. After the pressure is allowed to stabilize, it is monitored for a predetermined amount of time. The acceptable range of pressure drop and the duration of the test are based on the pipe material and diameter, detailed in American Society for Testing and Materials (ASTM)

standards. An unacceptable drop in the pressure indicates that the pipe has leaks that could lead to excessive infiltration. To isolate the leaks, air testing can be repeated on smaller sections of line.

Hydrostatic Testing

Hydrostatic testing is another technique used to detect and locate leaks in a sewer system. As with air testing, the sewer reach of interest is isolated using plugs. The test section is filled with standing water and the water level is monitored. A drop in the water level over time indicates the presence of leaks. The acceptable decrease in water level and the test duration are specified in ASTM standards based on pipe material.

Smoke Testing

Smoke testing is commonly used to detect sources of unwanted inflow such as down spouts, or driveway and yard drains. With each end of the sewer of interest plugged, smoke is introduced into the test section, usually via a manhole. Sources of inflow can then be identified when smoke escapes through them. This technique can also be used to identify cross connections between sanitary and storm sewer systems. The smoke can be tracked through the sewer system for a limited distance. The length of the sewer that can be tested at one time is dependent on a number of environmental factors affecting smoke dissipation, such as wind and the number of sewer and surface connections to the system.

Sewer Inspection Techniques

Sewer inspection is an important component of any maintenance program. Sewer inspections establish the current condition of sewer lines and identify potential problems. The most common sewer system inspection techniques are described in detail below.

Visual Inspection

Visual inspection, which is the most basic sewer

inspection technique, can include surface and internal inspections. In either case, the manhole cover is removed and an inspection of the manhole condition, as well as the flow characteristics in the pipe, is made. For smaller pipes, mirrors and lights can be used to inspect the first few feet of pipe upstream and downstream of each accessible manhole. For larger pipes, a maintenance crew member can enter the pipe to inspect the inside of the pipe.

Lamping

Lamping involves lowering a still camera into a maintenance shaft or manhole. The camera is lined up with the centerline of the junction of the manhole frame and the sewer. A picture is then taken down the pipe using a strobe-like flash. This method can typically be used to inspect the first 10-12 feet of the pipe upstream and downstream from the access point.

Camera Inspection

Camera inspection is slightly more comprehensive than lamping. In camera inspections, a still camera is mounted on a floatable raft that is released into a pipe. As it floats down in the sewer, the camera takes pictures of the pipe using a strobe-like flash. Camera inspections can be performed in any pipe that is large enough to accommodate the camera and raft device.

Closed-Circuit Television

Closed-circuit television (CCTV) is the most commonly used technique for inspecting the internal condition of a sewer (EPA 1999). A closed-circuit camera with a light is self-propelled or pulled down the pipe. As it moves, it records the interior of the pipe. The focus of the camera can be controlled remotely for a clear image of points of interest. The distance traveled is recorded so that the location of any irregularities can be noted. This technique can be used in lines with a diameter ranging from 4-inches to 48-inches (CSU 2001).

Sonar

Sonar is a newer technology available for inspecting sewer lines. Sonar is deployed in the same manner as CCTV cameras and, therefore, can be used in the same diameter pipes. Sonar works by emitting a pulse that is bounced off the walls of the sewer. The time it takes for the pulse to bounce back is a function of the wall geometry. This wall geometry can then be analyzed to develop an image of the interior of the pipe. At low frequencies, less than 200 kHz, the pulse can penetrate the walls and provide information on the structural condition of the pipe.

Sewer Scanner and Evaluation Technology

Sewer Scanner and Evaluation Technology (SSET) is an experimental sewer line inspection technology. A full digital picture of the interior of a pipe can be produced by using a probe with a 360 degree scanner.

Key Considerations

Sewer Testing Techniques

The location and elimination of leaks in a sewer system are the major concern of system operators (CSU 2001). An effective sewer testing and inspection program will identify existing leaks and prevent other leaks from developing. Key considerations, including advantages and disadvantages, in selecting appropriate testing and inspection techniques are detailed below.

Air Testing

Air testing tests the entire circumference of the pipe for leaks by exerting the same amount of pressure in all directions on the pipe. Air can leak through a smaller crack than wastewater, therefore air testing helps find vapor leaks which may attract roots. In addition, in areas with steep terrain, air tests are better than water tests because of excessive hydrostatic pressure created at the lower end of the sewer line (CSU 2001). However, air testing can be difficult to apply in areas that have numerous service lateral connections as each one must be individually plugged, and the test section must be taken out of service during air testing. Due to safety concerns, air testing can also only be used in 4-inch to 24-inch pipes. For example, pressure on a 24-inch plug, even during a low pressure test, is enough to cause an improperly installed plug to explode (Rinker Material 2002).

Hydrostatic Testing

Hydrostatic testing also requires that the test section be taken out of service during testing. Individual service lateral connections do not need to be plugged as long as the water level at which the test is conducted is below that of the lowest basement in the test area. However, if residential taps are not plugged, the service laterals will be included in the test area. Further, since the release of pressure due to a failure of a plug in the hydrostatic test is much lower than in an air test, it can be conducted in larger diameter pipes. The principle disadvantages of hydrostatic testing are the time, money, and water wasted in conducting these tests (CSU 2001).

Smoke Testing

Smoke testing does not require the test section to be removed from service. However, all floor and sink drains must be filled with water prior to introducing

smoke to the system. Use of smoke testing is best done when the groundwater levels are low (i.e., below the elevation of the pipe) so that any cracks will leak smoke. It is important to realize that the location of smoke on the ground surface does not necessarily reveal where the smoke is escaping underground, but rather the point of exit at the ground surface (CSU 2001).

Sewer Inspection Techniques

Logging and recording inspections is critical to ensuring their utility. Typically, each municipality will have a standard log sheet for recording observations made through any of the inspection techniques described below. In cases where old sewers are to be inspected, it may be important to clean the lines before inspection. Ideally, sewer line inspections will take place during low flow conditions. Key considerations for different inspection techniques are discussed below.

Visual Inspections

In conducting visual inspections of sewer interiors, the maintenance crew is required by law to have confined space entry training and to strictly follow confined space entry procedures. Safety concerns also arise when attempting visual inspections in sewers with access points more than 600 feet apart.

Lamping

Lamping does not require confined space entry. Additionally, little equipment and set-up time are needed. Inspection is only possible, however, in the areas clearly captured in the photograph. Further, lamping has limited use in small diameter sewers (CSU 2001).

Camera Inspection

Camera inspection is often a viable alternative to visual inspections in larger sewers when the access points are more than 900 feet apart. The main disadvantage of camera inspection, similar to lamping, is that the pictures are not comprehensive and portions of the pipe may be missed. Additionally, there must be flow in the pipe for the raft to float. If there is flow in the pipe usually the invert of the pipe cannot be seen and is not photographed. Therefore, this method of inspection does not fully capture the condition of the invert of the pipe.

Closed-Circuit Television

One of the primary advantages of CCTV over still-photography methods, such as lamping and camera inspections, is that the camera can be stopped and pulled back or forth for a more precise observation. A footage meter can also be used in conjunction with CCTV equipment to keep track of the location of any irregularities. CCTV, however, cannot capture pipe condition below the water. In addition, CCTV-based assessment is subjective and can be error prone as its

accuracy depends heavily on the skill and concentration of the operator.

Sonar Technology

Sonar technology is able to map the sewer condition both above and below the level of flow. The primary use for sonar equipment is to inspect and assess the structural condition of otherwise inaccessible or flooded sections of sewer lines. The disadvantage is that it requires more power and heavy equipment than the CCTV, and therefore tends to be more expensive.

Sewer Scanner and Evaluation Technology

Similar to sonar, SSET also offers the benefits of a more complete image of the pipe than CCTV, but this technology is still in the experimental phase. SSET does not identify all types of sewer defects, such as infiltration and corrosion, equally. Also, it is not possible to see laterals, and SSET is slow compared to CCTV (CERF 2000). It appears that comprehensive data on the condition of the pipeline can be determined by combining SSET with CCTV.

Cost

Costs for testing and inspection will vary based on location and technique used. CCTV is the most commonly used inspection technique and the costs are presented in Table 1.

Table 1. CCTV costs per linear foot, includes labor and equipment costs.

Location	CCTV ¹
Los Angeles, CA	\$0.57
Sacramento, CA	\$1.63
Santa Rosa, CA	\$0.27
Honolulu, HI	\$3.24
Boston, MA	\$1.89 - \$2.70
Laurel, MD	\$1.72
Albuquerque, NM	\$1.56
Charleston, SC	\$0.39
Fort Worth, TX	\$0.48
Fairfax County, VA	\$0.81
Norfolk, VA	\$1.62
Virginia Beach, VA	\$1.56 - \$1.73
Average	\$1.44

¹ Costs in 2002 dollars.

Implementation Examples

FORT WORTH, TX

Responsible Agency: City of Fort Worth

Population Served: 880,000

Service Area: 291 sq. mi.

Sewer System: 2,589 mi. of sewer

Sewer Maintenance and Service Program

The City of Fort Worth Water Department created a Preventative Maintenance Section and a Technical Service Section in 1998. The Preventative Maintenance Section was tasked with implementing a system-wide small diameter (less than 18 inches) sewer cleaning and inspection program. Larger pipes are cleaned and inspected by private contractors, due to technical logistics and the specialized equipment needed. The Sewer Maintenance Section handles

all other sewer maintenance activities such as cleaning blockages, and pipe installation and repair. The sewer system is divided into nine major drainage basins containing 167 subbasins. Each subbasin, along with its SSO and maintenance histories, is tracked in a Geographic Information System (GIS) database. Spatial analysis based on information from the GIS database and baseline performance criteria is used to prioritize the cleaning and inspection of the subbasins. Once a subbasin is selected for cleaning, approximately two-thirds of the cleaned lines are evaluated by CCTV. This information is used as part of the decision making process for determining whether or not further maintenance is needed. During 2001-2002, 176 miles of pipe were televised. The cost for inspection of small diameter sewers by city employees was \$0.48 per linear foot including labor and equipment.

Contact: Darrell Gadberry, City of Fort Worth Water Department, Field Operations Division

FAIRFAX COUNTY, VA

Responsible Agency: Fairfax County

Population Served: 835,000

Service Area: 234 sq. mi.

Sewer System: 3,100 mi. of sewer

Improved Sewer Maintenance Program

Fairfax County believes that improved record keeping, along with the reorganization and streamlining of their sewer maintenance program, has resulted in significant reductions in SSOs in recent years. By tracking the number of inspections and cleanings, as well as the number of overflows in each individual line, the county has established and prioritized inspection and cleaning schedules for

each line. This customized cleaning and inspection schedule, along with the resulting decrease in SSOs, led to a decrease in overall sewer maintenance costs. Inspection activities include visual inspection using a mirror attached to a pole, a portable camera, and CCTV. The sewers are then cleaned based on the regular schedule or sooner, as determined by the inspection results. In 2002, the cost of visual inspection and cleaning was \$0.87 per linear foot. The cost of CCTV inspection was \$0.78 per linear foot.

Contact: Ifty Khan, Fairfax County Department of Public Works & Environmental Services, Wastewater Collection Division

References

California State University (CSU), Sacramento, College of Engineering and Computer Science, Office of Water Programs. 2001. *Operation and Maintenance of Wastewater Collection Systems*. Vol. 1, 5th ed. Prepared for EPA Office of Water Programs, Municipal Permits and Operations Division. Sacramento, CA: CSU, Sacramento Foundation.

Civil Engineering Research Foundation (CERF). 2000. *Sewer Scanner & Evaluation Technology (SSET)*. Retrieved July 28, 2003. <http://www.cerf.org/ceitec/eval/ongoing/sset.htm>

EPA Office of Water. 1999. *Collection System O&M Fact Sheet: Sewer Cleaning and Inspection*. EPA 832-F-99-031.

Rinker Materials. 2002. *Information Series: Low Pressure Air Testing*. Retrieved July 28, 2003. <http://www.rinker.com/hydroconduit/infobriefs/i105.htm>

Inclusion of this technology description in this Report to Congress does not imply endorsement of this technology by EPA and does not suggest that this technology is appropriate in all situations. Use of this technology does not guarantee regulatory compliance. The technology description is solely informational in intent.



Sewer Cleaning Techniques

Overview

Operations and maintenance practices, such as sewer cleaning, enhance sewer system performance. Specifically, sewer cleaning can remove blockages caused by the deposition of solids and grease, as well as root intrusion. Sewer cleaning is important in maintaining sewer system capacity and can reduce the frequency and volume of CSOs and SSOs.

The three major techniques used to clean wastewater sewer systems are hydraulic, mechanical, and chemical. Some of the more widely used technologies in each of these categories are described below.

Hydraulic Cleaning Techniques

Jetting

Jetting involves aiming a high-pressure stream of water at the blockage or debris in the pipe. The shape of the nozzle can be changed depending on the surface in need of cleaning (CSU 2001). Jet cleaners can either be truck- or trailer-mounted. Jet cleaners are very efficient, require minimal staff, and are able to handle most types of sewers and blockages. Jetting is the most common hydraulic cleaning technique due to its comparatively low cost and effective cleaning results.

Balling

Balling involves inserting a rubber ball with a diameter slightly smaller than the interior diameter of the pipe into a sewer line. The ball is placed in the upstream end of the sewer line and reduces the area through which wastewater can pass, causing it to flow at a higher velocity. This increased velocity flow scours the interior of the pipe. Additional cleaning can also be achieved by threading the ball so that it spins as water flows past, scrubbing the interior of the pipe.

Kites

Kites are cone shaped devices that resemble a windsock and are used to hydraulically clean sewers. Kites work

similar to balling, increasing the velocity of the flow so that it scours the sewer line. They are made of a canvas material that traps and funnels the wastewater so that it is released as a high velocity stream. This wastewater stream works to break up deposits in the line.

Scoters

Scoters consist of a metal shield attached to a wheeled framework and are designed to be self-propelled. The shields are available in various sizes for use in different diameter pipes. Similar to the balling technique, the scooter blocks the flow in the pipe and forces it to go around the edges of the shield at a high velocity. The wheeled framework allows the scooter to be pushed by the wastewater built up behind it. The depth of wastewater behind the scooter is controlled by a spring system that adjusts the angle of the shield relative to the walls of the pipe. By adjusting the angle of the shield, the flow around the edges is either increased or decreased. The high velocity water flowing around the shield breaks up and moves debris down the pipe.

Flushing

There are two methods used in flushing sewers: manual flushing and self-flushing. Manual flushing involves introducing large volumes of low velocity water at the upstream end of the sewer. The large flow volume is capable of transporting floatables and low density, loose debris to the downstream manhole for removal, but not necessarily heavy or attached debris. This method is most effective when used in combination with a mechanical method such as rodding. Self-flushing techniques use the flow within the sewer for hydraulic cleaning. A gate or other device is used to store a volume of wastewater and then release it in a flood wave that washes deposits out of the sewer line.

Mechanical Cleaning Techniques

Rodding

Power rodding machines use an engine to force a

small diameter rod (less than one inch) through the sewer line. The rod turns as it passes through the pipe. Usually a cleaning attachment made of multiple small blades is located at the end of the rod. The attachment works to loosen and break up debris; it also cuts through roots that protrude into the interior of the pipe. In addition, power rodding can be used to thread cables for closed-circuit television (CCTV) inspection or bucket cleaning.

Bucket Machines

Bucket machines use a steel bucket that is pulled through the sewer along a cable threaded between two manholes. The front of the bucket has jaws that open and scrape the debris and deposits from the interior of the pipe capturing them in the bucket for removal. Bucket machines are available in a range of sizes to allow for cleaning of both small and large diameter pipes. The power of the equipment being used to pull the bucket determines the size of the pipe that can be cleaned with this method.

Chemical Grouting Techniques

Herbicides

Roots can inhibit flow, collect debris, and reduce the line's capacity. Herbicides are used to kill roots protruding into the sewer line and inhibit future root growth. Herbicides are typically applied by one of two methods: soaking the roots inside the sewer with a liquid solution for a short time period, or filling the sewer with a herbicidal foam. Chemical root control must be used in combination with some other cleaning technique to remove the roots killed by the herbicides.

Enzyme Additives

Enzyme additives can be used to break up scum, grease, and other accumulated organic matter. These additives can control odors in the sewer system as well as removing blockages. The additives usually come in a dry flaky form and are applied in small doses.

Key Considerations

Selection of the most appropriate sewer cleaning technique will need to be made on a site-specific basis. In general, hydraulic cleaning techniques tend to be simpler and more cost-effective in removing deposited solids when compared to other sewer cleaning techniques (CSU 2001). Mechanical techniques are typically used in areas where the volume, size, weight, or type of debris limit the effectiveness of hydraulic techniques. Chemicals can be helpful aids for cleaning and maintaining sewers, but most chemical applications are localized or used to enhance the effectiveness of other cleaning techniques. Specific

considerations for each of the aforementioned cleaning techniques are described below.

Applicability

Hydraulic Cleaning Techniques

Jetting

Jetting is most effective in cleaning flat, slow-flowing, smaller pipes (less than 15 inches in diameter). As the pipe diameter increases, the distance between the high velocity nozzle and the interior of the pipe increases, which decreases its cleaning potential. Jetting is often more effective in low flow pipes as the jets can easily penetrate shallow flow to clean the deposits in the invert of the pipe. Jetting must be used with caution in pipes with fixtures such as gauges and valves as they may be damaged by the jets. Basement backups can occur if the jetting hose is mistakenly fed into a service line, or if the volume of water introduced exceeds the capacity of the sewer line.

Balling

Balling is best suited for removing deposits of inorganic material and grease (CSU 2001). Balling can only be used in areas where sufficient hydraulic capacity is available to pressurize the water flowing around the ball without causing sewer backups, and it is most successful in 24-inch or smaller diameter pipes. It cannot be used in sewer lines that have large offsets, service connections, or roots protruding into the sewer line since the ball can get caught. The required frequency of balling varies from six months to three years (CSU 2001).

Kites

Kites clean in a manner similar to balling, but they are commonly used to clean larger diameter sewers. Kites require only a small amount of hydraulic pressure to create a cleansing velocity. Yet, they can only be used in areas where sufficient hydraulic capacity is available to pressurize the water flowing around the kite without causing sewer backups. Some accommodation for hydraulic capacity can be made by feeding the kite through the system at a faster rate. However, this faster rate may not allow for sufficient pressurization of the water flowing out of the end of the kite. A kite cannot be used in pipes with large offsets, which could cause the kite to become lodged in the line.

Scooters

Scooters are capable of removing large objects and heavy materials (i.e., brick, sand, gravel, and rocks). Scooters are considered more effective in larger lines, over 18 inches in diameter (CSU 2001). The operation of a scooter is quite simple, and the cost is often

considerably less than other cleaning operations. Since scooters depend on the build-up of water pressure, caution must be used where sewers are shallow or the danger of flooding homes or businesses exists. A scooter cannot be used in lines with protruding pipes or service lateral connections, and it may not be appropriate for lines with significant root intrusion, where it could become entangled.

Flushing

Flushing is most often used in conjunction with other mechanical techniques, especially rodding. Mechanical devices are used to cut roots and grease from the walls and joints of pipes. This is followed by flushing to remove the cut material. Flushing is not as effective as balling or jetting because sufficient velocities are not developed to remove grease, grit, or heavy debris. It is also important to note that the amount of water required to clean a line is dependent on the size, length, and slope of the line. Flushing is not a common practice due to poor results and large volumes of water required for cleaning, which ultimately flow to the wastewater treatment plant.

Mechanical Cleaning Techniques

Rodding

Rodding is one of the most widely used methods for cleaning sewers. Rodding is typically used to handle stubborn stoppages of roots, grease, and debris (CSU 2001). This method works best when applied in pipes with diameters of 12 inches or less. When used in larger diameter pipes, the rod tends to bend and coil up on itself. Rodding is most effective when it is applied in conjunction with some form of flushing because it works to loosen and break up debris, but rodding itself does not remove debris from the line. If the rod happens to break in the sewer line, retrieval and repair may be very difficult.

Bucket Machines

Bucket machines are most often used to clean a line after a pipe breaks or debris that cannot be removed by hydraulic cleaning techniques accumulates. They should not be used as a routine cleaning tool. Bucket machines are heavy, and set-up of the equipment is more time consuming than for other mechanical methods. In addition, if the sewer line is completely blocked, the pull cable cannot be threaded through the line, making this method ineffective. Bucket machines are costly to operate and maintain, and they can be potentially damaging to sewer pipes.

Chemical Cleaning Techniques

Herbicides

Proper application of chemical root control is essential in ensuring their effectiveness. Root control using chemicals is not as fast as cutting roots with a power rodder, however, it is more permanent. Effective chemical application can control roots in a sewer for two to five years (CSU 2001). It is important to take into consideration how the toxicity of the herbicide will affect the biological treatment process at the downstream wastewater treatment plant.

Enzyme Additives

The addition of enzyme additives to control grease and scum are effective under specified conditions in specific locations. Careful comparison of the results produced by the additives with those achieved via mechanical or hydraulic cleaning methods should be made to ensure that the most appropriate technique is selected.

Cost

Representative costs for various cleaning methods are summarized in Table 1. The relative effectiveness of the cleaning techniques is presented in Table 2.

Table 1. Cleaning costs per linear foot.

Municipality	Cleaning Method	Average Cost per Linear Foot ¹
Los Angeles, CA	Hydraulic - Jetting	\$0.27
	Mechanical - Rodding	\$0.41
	Mechanical - Manual Rodding	\$1.32
San Diego, CA	Overall Cleaning	\$0.54
Hammond, IN	Overall Cleaning	\$1.26
Afton, OH	Overall Cleaning	\$0.42
Sioux Falls, SD	Overall Cleaning	\$0.45
Fort Worth, TX	Overall Cleaning	\$0.61 - \$1.02
Fairfax, VA	Hydraulic - Jetting	\$0.44
	Mechanical - Rodding	\$0.86

¹ Costs include labor and equipment.

Table 2. Effectiveness of sewer cleaning techniques (CSU 2001).

Cleaning Technique	Maintenance Issue (Effectiveness scaled from 1=low to 5=high)				
	Emergency Stoppage	Grease	Roots	Sand, Grit, Debris	Odors
Jetting ¹	5	5	-	4	3
Balling	-	4	-	4	3
Kiting	-	4	-	4	3
Scooters	-	3	-	3	-
Flushing	-	-	-	-	2
Rodding	4	1	3	-	-
Bucket Machines	-	-	-	4	-
Chemicals	-	2	-	5	5
Microorganisms	-	4	-	-	-

¹ Effectiveness decreases as pipe diameter increases.

Implementation Examples

SIoux FALLS, SD

Sewer Cleaning and Maintenance

Responsible Agency: City of Sioux Falls
Population Served: 120,000
Service Area: 70 sq. mi.
Sewer System: 578 mi. of sewer

The City of Sioux Falls' sewer system consists of 578 miles of sanitary pipe. The pipes range in size from 6-66 inches in diameter. The sewer system is divided into 20 drainage basins, and the current maintenance program provides that the entire system is cleaned once every three years. Maintenance records are stored in an Oracle database that generates work orders by date and drainage basin. Sanitary sewer maintenance includes high pressure jetting, vacuuming

to remove loosened debris, and mechanical and chemical root control. Closed circuit televising (CCTV) is used to identify trouble spots, where more frequent cleaning is required than the scheduled three year intervals. In 2001, 372 miles of sewer (64 percent of the system) were cleaned and televised. The cost for these maintenance activities equates to \$236 per 5,280 feet (1 mile) of inch-diameter pipe. Using a ten-inch diameter pipe as an average, maintenance costs are about \$0.45 per linear foot.

Contact: Richard McKee, M.O.U. Public Works, Water Reclamation Division

FORT WORTH, TX

Sewer Cleaning Efforts

Responsible Agency: City of Fort Worth
Population Served: 880,000
Service Area: 291 sq. mi.
Sewer System: 2,589 mi. of sewer

The City of Fort Worth's sewer system consists of approximately 2,589 miles of pipe. The pipes range in size from 6-96 inches in diameter. Ninety percent of the system is composed of pipes with diameters of 18 inches or less. The city has established maintenance goals which include cleaning all sewers 18 inches or smaller once every eight years and all sewers larger than 18 inches once every 15 years. The cleaning and maintenance of the smaller diameter

pipes is conducted by city employees, while the cleaning of larger diameter pipes is outsourced due to technical logistics and the specialized equipment needed.

The sewer system is divided into nine major drainage basins containing 167 subbasins. Each subbasin, along with its SSO and maintenance histories, is contained in a Geographic Information System (GIS) database. Spatial analysis of the GIS database is compared to baseline performance indicators to prioritize the cleaning order of the subbasins. In 2001-2002, 1.15 million linear feet of pipe were cleaned by the city. The cost for city cleaning activities during this time, including labor and equipment, was \$0.61 per linear foot (in 2002 dollars) and the cost for cleaning of larger pipes by private contractors was \$1.02 per linear foot (in 2002 dollars).

Contact: Darrell Gadberry, City of Fort Worth, Water Department, Field Operations Division

References

Arbour, Rick, and Ken Kerri. 1998. *Collection Systems: Methods for Evaluating and Improving Performance*. Prepared for EPA, Office of Water Programs, Municipal Permits and Operations Division and developed under EPA Grant No. CX924908-01-0. Sacramento, CA: California State University, Sacramento Foundation.

California State University (CSU), Sacramento - College of Engineering and Computer Science, Office of Water Programs. 2001. *Operation and Maintenance of Wastewater Collection Systems*. Vol. 1, 5th ed. Prepared for EPA Office of Water Programs, Municipal Permits and Operations Division. Sacramento, CA: CSU, Sacramento Foundation.

EPA Office of Research and Development. 1998. *Sewer and Tank Sediment Flushing: Case Studies*. Prepared by Pisano, William C., et al. EPA 600-R-98-157.

EPA Office of Water. 1999. *Collection System O&M Fact Sheet: Sewer Cleaning and Inspection*. EPA 832-F-99-031.

Fan, Chi-Yuan, Richard Field, William C. Pisano, James Barsanto, James Joyce, and Harvey Sorenson. 2001. "Sewer and Tank Flushing for Sediment, Corrosion, and Pollution Control." *Journal of Water Resources Planning and Management*. May/June: 194-201.

Mitchell, Scott E. 2001. "Benchmarking Operations for Sewer Cleaning vs. Private Contractor - Cost Analyses, 1997-2001." Retrieved July 28, 2003. <http://www.ci.hammond.in.us/sewer/paper.html>

Inclusion of this technology description in this Report to Congress does not imply endorsement of this technology by EPA and does not suggest that this technology is appropriate in all situations. Use of this technology does not guarantee regulatory compliance. The technology description is solely informational in intent.



Pollution Prevention

Overview

Pollution prevention is defined as any practice that reduces the amount of pollutants, hazardous substances, or contaminants entering the waste stream (EPA 2002). Pollution prevention focuses on source control, seeking to reduce the pollutants generated by a particular process. It relies on individual action, and therefore, public education and awareness. A range of pollution prevention activities including best management practices (BMPs) for fats, oils, and grease; household hazardous waste; and commercial and industrial facilities are detailed below.

Fat, Oil, and Grease Control Programs

Fat, oil, and grease (FOG) are a by-product of many food items that are prepared in homes and restaurants. Often, when used for cooking, FOG is improperly disposed of by pouring it down a sink drain. FOG can also enter the sewer system when dishes are washed. Over time, FOG builds up in sewers, leads to blockages, and can cause combined and sanitary sewer overflows (CSOs and SSOs).

Nationally, EPA believes that FOG is one of the leading causes of SSOs contributing to approximately one out of every five SSOs. The best way to prevent these blockages is to keep FOG out of the sewer system. Education programs are important in ensuring residents, institutional, and commercial establishments, especially restaurants, are aware of their role in managing FOG. In addition, many municipalities have adopted regulations controlling the introduction of FOG into the sewer system.

In commercial areas, grease traps or interceptors are often used to remove FOG from wastewater before it enters the sewer system. Grease traps slow the flow of wastewater, allowing it to cool and FOG to float to the top of the trap. Baffles are located at the beginning and end of the trap to prevent FOG from escaping as shown in Figure 1. The size of the trap depends on the anticipated flow and the amount of FOG in the wastewater. Grease trap capacities range from small units (less than 10 gallons) located in the kitchen area to 5,000 gallon tanks installed underground outside the

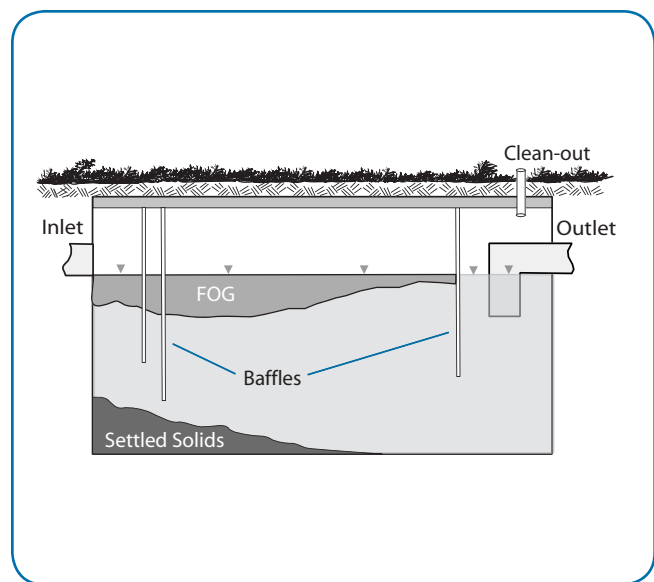

Figure 1. A schematic showing the collection of FOG by a grease trap located within a sewer line.

building (NCDPPEA 2002). Often, for restaurants, the size of the trap is determined by the number of seats.

Household Hazardous Waste Management

Household hazardous waste includes products that are corrosive, toxic, reactive, or flammable. Household hazardous waste management focuses on the proper application and disposal of these otherwise hazardous materials. Common household hazardous waste are paint thinners, auto batteries, pesticides, and oven cleaners.

Household hazardous waste collection programs highlight the importance of proper disposal of these materials and potential hazards resulting from improper disposal (i.e., pouring down kitchen sinks or storm drains and thus into the sewer system). Collection programs typically include schedules for home pick-up or drop-off points for the waste.

The inappropriate or excessive application of fertilizer and pesticide can allow large amounts of these chemicals to be washed off lawns and other landscaped areas during wet weather events. Fertilizer contains nitrogen and phosphorous that can contribute to the eutrophication of receiving waters. Pesticides contain chemicals that are toxic to aquatic life and can impact the biological processes used at the wastewater treatment plant. In areas served by combined sewers, runoff contaminated with fertilizer and pesticides may be discharged during a CSO event. Drain disposal of chemical remnants can also introduce the fertilizer or pesticide into the sewer system.

Integrated pest management (IPM) programs can be effective in limiting fertilizer and pesticide application. IPM programs teach residents the difference between insects that are beneficial and harmful to plants to avoid the over use of pesticides. For example, if one branch of an azalea bush is infected with an azalea lace bug, that branch can be cut out of the bush eliminating the pest and reducing the need for pesticide (NVPDC 1996). Further, IPM programs advocate using a diverse selection of native plants and maintaining a healthy plant bed by using organic compost instead of fertilizer.

Commercial and Industrial Waste Management

Commercial and industrial facilities can discharge large amounts of pollutants to sewer systems through direct disposal or storm water runoff (EPA 1999). Pollution prevention plans that incorporate storm water BMPs and water conservation measures can play an important role in reducing the pollutants discharged directly to the sewer system, as well as those washed-off commercial and industrial sites during wet weather events. BMPs for commercial and industrial sites can be used to control the volume or quality of storm water runoff. BMPs may include using temporary covers for outside storage areas, installing covered bays for vehicle maintenance, purchasing rain proof dumpsters, and adopting environmentally-friendly building and grounds maintenance practices. Water conservation measures at commercial and industrial facilities often include installing water efficient fixtures such as low-flow toilets and faucets and reusing or recycling cooling water. For more information on water conservation activities, refer to the “Water Conservation Technology Description” in Appendix B of the *Report to Congress on the Impacts and Controls of CSOs and SSOs*.

Key Considerations

Pollution prevention practices most often take the form of simple, individual actions which reduce the pollutants generated by a particular activity. Therefore, pollution prevention programs must be implemented with broad

participation in order for there to be a discernible reduction in pollutant loads discharged to sewer systems. Specific considerations for each of the pollution prevention practices described above are provided below.

Applicability

Fat, Oil, and Grease Control Programs

FOG is a common problem in both combined sewer systems (CSSs) and sanitary sewer system (SSSs). Numerous municipalities have invested in programs to educate customers about the proper handling and disposal of FOG. Education programs are most successful if they are tailored to a specific audience (i.e., residential, institutional, or commercial).

Education programs should make residents aware that FOG can block private laterals, in addition to municipal sewers, resulting in basement backups. Utility bill inserts, direct mailings, newspaper articles, and community events are ways to reach residential customers (NCDPPEA 2002). Outreach materials can include a “Do and Don’t” list such as the following:

Do:

- Collect FOG in a container and dispose of it with the trash
- Scrape grease and food from cooking/serving ware before washing
- Encourage neighbors and friends to help eliminate FOG from the sewers

Don’t:

- Pour FOG down the sink drain or toilet
- Put greasy waste or food down garbage disposals
- Place FOG wastes in the toilet

Education for commercial and institutional customers can take the form of workshops, mailings, and web information. Workshops provide a forum for disseminating information concerning environmental and health effects of FOG, BMPs for controlling FOG, and any municipal ordinances that pertain to FOG. Workshops can emphasize the important link between employee behavior and possible FOG blockages. If new ordinances are put into place, direct mailings can be used to inform those effected of their new responsibilities, as well as techniques for controlling FOG.

A vital part of any education program for commercial and institutional customers is discussion of grease trap design and maintenance. Grease traps do not remove all the FOG in the wastewater; proper design and regular maintenance is critical for effective grease trap performance. The effective separation of water and grease is based on four design criteria (NCDPPEA 2002):

- Sufficient volume to allow the wastewater to cool for separation
- Proper retention time for the FOG to separate from the wastewater
- Low turbulence to prevent FOG and solids from resuspending
- Adequate volume to handle the accumulation of FOG and solids between cleanings

Household Hazardous Waste Management

Programs that promote appropriate disposal of household hazardous waste and the proper application of fertilizers and pesticides can be instituted in any community.

Household hazardous waste collection programs provide information to residents about materials that are considered hazardous and provide opportunities for proper disposal. State or local governments can establish a network of regional, local, or mobile household hazardous waste collection facilities providing residents with multiple options for disposing of the waste (MPCA 2002). Municipalities may organize simple or elaborate drop off events that incorporate other environmental education programs.

The control of fertilizer and pesticide levels involves convincing residents, institutions, and municipal departments to adhere to handling and application techniques that limit pollutant runoff. Public education programs should emphasize that “more is not better,” and that the lowest effective dose listed on the label for any one application should always be used. Education programs can also include information on IPM and other alternative pest control measures. The caretakers of large parcels of urban land, including local park departments and other institutions, should be encouraged to demonstrate the responsible use of fertilizers and pesticides.

Commercial and Industrial Waste Management

The development and implementation of a pollution prevention plan can benefit almost any commercial or industrial facility. Pollution prevention plans can reduce operating costs and improve the facility’s public image, while reducing the quantity of pollutants generated. Technical assistance and incentives may also be used to encourage commercial and industrial facilities to participate.

Some states, regional agencies, and counties have developed programs to aid businesses in developing pollution prevention plans. These programs typically include a waste analysis to determine which portions of the commercial or industrial facility’s production could benefit from waste reduction measures and services to help implement the suggested measures.

Water conservation measures can be an important component of a pollution prevention plan helping to reduce the amount of water consumed by commercial and industrial operations. This in turn reduces the amount of water discharged to the sewer system. When establishing a water conservation plan, a facility should perform a water audit to survey its water use. The true cost of water usage can then be calculated by considering the water and sewer costs, on-site wastewater treatment costs, if any, and energy costs to heat or pump water. After water use is characterized, areas for improvement can be identified and prioritized. Changes in behavior, as well as the replacement or retrofit of equipment, can be used to implement more efficient water use practices.

Cost

Pollution prevention measures are site-specific, and it is therefore difficult to compare costs between programs. Tables 1 and 2 provide cost examples for pollution prevention practices. Table 2 specifically details commercial and industrial pollution prevention measures including potential cost savings.

Table 1. Example costs associated with pollution prevention programs.

Technology	Program	Typical Costs
Fats, Oil, Grease	Education Program	Raleigh, NC- Budgeted \$100,000 for program set-up and \$50,000 annually for implementation.
	Grease Trap/Interceptor	Wisconsin - Grease traps can cost \$750 per cubic foot or \$211,000 per structure. ²
Household Waste Management	Hazardous Household Waste Management	Jefferson County, KY - Operates a permanent collection facility for hazardous household materials. The annual operation budget is \$250,000 and they collect approximately 150,000 lbs. per year (\$3,333/ton or \$1.67/lb.). Greater Detroit Resource Recovery Authority - Collected 60 tons of waste in 1995 for \$223,000 (\$3,716/ton or \$1.86/lb.). ²
	Fertilizer and Pesticide Control	Lovinia, MI - Spent an average of \$80,918 annually for their hazardous household materials collection program from 1991- 1995. The average disposal cost was \$12.19/gallon. ² Prince William County, VA - Provides soil test kits to residents for \$10, which includes analysis for fertilizer needs. ²
	Waste Management	King County, WA - Operates the Industrial Materials Exchange, which helps businesses find markets for their surplus materials, wastes, and industrial by-products. The annual operating budget is \$250,000. Waste Reduction Partners of the Land-of-Sky Regional Council, Ashland, NC - Annual budget for 2001 was \$132,097. In 2001, the program diverted 10,609 tons of solid waste from landfills. ³

¹ EPA 1999, ²Ferguson, et al. 1997, ³ Land-of-Sky 2001

Table 2. Examples of commercial and industrial pollution prevention programs.

Company	State	Program	Activity	Capital Cost	Cost Savings/Yr.	Results
Air Products and Chemicals, Inc.	OH	Wastewater Discharge Reduction	Batch seal pot water is recovered and reused in continuous emulsion process	\$1,000	\$2,000	Reduced waste flow to sewer system by 56% annually.
Cooper Hand Tools	NC	Reuse Hazardous Waste Reduction	Concentrate chromic acid rinse water for reuse and recover nickel from nickel electroplating bath sludge	N/A	\$68,000	Reduced purchase of new chromic acid by 10,000 lbs. annually. Eliminated generation of 12 tons of hazardous waste annually.
Frigo Cheese Corporation	WI	Reuse	Salt whey recovery and reuse by evaporation	\$2,000	N/A	Not Available
Lockheed Martin	GA	Hazardous Waste Reduction	Minimized paint waste through improved planning	\$4,000	\$120,649	Reduced hazardous waste stream by 2,020 gallons annually.
Quality Metal Products/Sheet Metal Shop	CO	Hazardous Waste Reduction	Installed solvent recovery unit	\$14,700	\$13,000	Prevented formation of 375 gallons of hazardous liquid waste annually.
Small Engine Manufacturer	WI	Hazardous Waste Reduction	Replaced chlorinated solvents with aqueous cleaners for parts cleaning.	\$10,000	N/A	Not Available
Unilever Home and Personal Care, Inc.	GA	Water Conservation Plan	Reuse of cooling water and collected rainwater used in the manufacturing process.	N/A	\$20,000	Reduced wastewater effluent by 77%. No longer a Significant Industrial User in relation to pretreatment program.

Implementation Examples

RALEIGH, NC

Responsible Agency: City of Raleigh Department of Public Works

Population Served: ~315,000

Service Area: Not Available

Sewer System: 1,525 mi. of sewer

City of Raleigh's annual Water Fest; and developed informational brochures. The website contains information about grease and its affect on the sewer system including a "Do and Don't" list. The first newspaper advertisement run by the city is shown.

The city's efforts continue to educate the public on the proper disposal of grease. Currently, a video is being developed for civic groups and students. Public service announcements on grease management will air on community and network television stations. Press releases reminding citizens about the problems grease can cause in the sewer system will also continue. Also, water bills will contain informational inserts.

During 2001, the city experienced 51 SSO events, a 22 percent reduction from the previous year. The city attributes this reduction to the FOG education program and an aggressive sewer maintenance program. The "Can Can" Program operates on an annual budget of \$50,000; the start-up cost of the program was \$100,000.

Public Education "Can Can" Campaign

In 1999, the City of Raleigh passed an ordinance that made it unlawful to dispose of grease by pouring it into the sewer system. To educate the public about this ordinance and their responsibilities, the city launched the "Can Can" Campaign in 2000. The city developed a website; produced television and newspaper advertisements and radio spots; sponsored a poster contest during the



More information at <http://www.raleigh-nc.org/pubaffairs/cancan/index.htm>

DENTON COUNTY, TX

Responsible Agency: Upper Trinity Regional Water District

Population Served: ~158,000

Service Area: Not Available

Sewer System: Not Available

the district's customers with ways to dispose of their hazardous wastes in an environmental-friendly manner. The collected waste is then transported in a specially modified cargo trailer to a regional disposal facility. The trailer was purchased in 1998 using a grant from the Texas Commission on Environmental Quality. During collection events, residents can drop off batteries, used car oil, solvents, antifreeze, herbicides, pesticides, aerosols, mercury, and paint. Paint is the most disposed item. The district charges each city \$80 per participating household for disposal fees and administration costs. The first collection event was held in June 1999. In 1999, a total of 375 households handed in 51,468 pounds of material. The total cost for the participating cities was approximately \$26,250.

Household Hazardous Waste Collection

The Upper Trinity Regional Water District in the Dallas/Fort Worth area provides drinking water, wastewater, hazardous waste management, biosolids management, and non-potable water supply services. Approximately 13 cities have contracts with the district for the specific services they need. In 1998, a household hazardous waste collection program was established to provide

More information at <http://www.utrwd.com/HHW.HTM>

ORANGE COUNTY, CA

FOG Control Study

Responsible Agency: Orange County Sanitation District

Population Served: 2.4 million

Service Area: 470 sq. mi., 23 cities

Sewer System: 650 mi. of sanitary sewer

A two-phase FOG control study is currently being conducted by the Orange County Sanitation District. The first phase, completed in March 2003, consists of a set of 13 building blocks that can be used interchangeably to create FOG programs specific to local conditions. The building blocks are grouped into four categories: programmatic, best management practices, best available technologies, and regional and watershed. A summary of the

draft report that details the building blocks of a FOG control program is presented. The second phase is on-going and involves field studies and pilot tests of FOG control technologies.

Cost comparisons of the various technologies that will be pilot tested as part of the FOG control study are not currently available. The first phase of the study cost \$268,000. It is expected that another \$1 million will be spent on pilot tests and system characterization.

Contact: Adriana Renescu

Building blocks of Orange County Sanitation District's FOG control study.

Programmatic Building Blocks	Description
FOG Characterization	Characterization of local FOG conditions including the extent and nature of SSO problems; identification of current or potential "hot spots".
Ordinance	Provides the legal framework for implementing a FOG program; establishes monitoring requirements, enforcement conditions, and fees.
Monitoring and Enforcement	Ensures that FOG control requirements are being followed. <i>Enforcement:</i> penalize entities that fail to correctly implement FOG controls.
Fees and Incentives	Fees, often in the form of increased sewer fees, pay for the FOG program. Reduced fees may be used as an incentive if commercial and institutional establishments can prove they are successfully implementing controls.
Education and Outreach	Many different stakeholders contribute to the success of FOG programs, it is important to identify and target key partners. Also, it is necessary to take into consideration language barriers (multilingual programs are required).

Best Management Practices

Kitchen BMPs	Practices to reduce and eliminate residential FOG before it enters the sewer system.
Collection System Cleaning	Collection system cleaning and TV-monitoring should focus on areas in the sewer system where FOG is most problematic.

Best Available Technologies

Grease Interceptors	Grease interceptors located outside of buildings that have a minimum volume of 750 gallons.
Passive Grease Traps	Small collection devices with volumes less than 50 gallons, which are installed under sinks and must be cleaned manually.
Automatic Grease Traps	Automatic grease traps are self-cleaning.
Biological Additives and Services	Biological additives digest FOG and prevent it from blocking sewer lines or overloading traps.
Chemical Additives	Chemical additives break down FOG and have been found to be useful in solving lift station grease problems.

Regional and Watershed

Grease Disposal Practices and Alternatives	Once FOG controls have been put in place, there must be grease disposal mechanisms available to customers. Such disposal methods include converting grease into biofuels and feeding the waste into POTW digesters. Also, it is important to regulate haulers and disposal sites to avoid illicit dumping.
--	--

PRINCE WILLIAM COUNTY, VA

Horticulture and Water Quality Program

Responsible Agency: Prince William County Cooperative Extension

Since the early 1990s, the Prince William County Cooperative Extension has administered a water quality program that educates residents about the effects of over fertilizing their lawns and using too many pesticides. Residents are recruited using direct mailings and programs with civic and homeowner associations. Once a resident registers with the program, they complete a pre-program survey and attend educational seminars such as "Fall Fertilization" and "IPM Basics". Upon completing the program, a master gardener volunteer visits with the residents to ensure that they are implementing the IPM and fertilization practices correctly. Finally, the resident completes a post-program survey. To date, over 2,000 households have completed Prince William's turf care and management program. To determine the effectiveness of the program, Prince William compared 1996 survey results from 600 participating households pre- and post-program. Results of the survey is summarized below.

Turf care and management program participant responses.

Participant Activities	Pre-Program	Post-Program
Tested soil to determine fertilizer rates	17%	78%
Linked excessive nutrients to water quality problems	60%	86%
Considered IPM to be important	42%	62%
Followed a fall fertilization schedule	50%	82%

The survey results showed reductions in fertilizer and pesticide application. The average amount of nitrogen applied to lawns was reduced by 40 percent, pesticide and water use were reduced by 25 percent, and the volume of yard trimmings sent to the landfill was reduced by 25 percent. The program is facilitated by a part-time water quality technician and master gardener volunteers. Prince William County's operating cost for the program ranges between \$5,000-\$10,000 annually. Except for the \$10 soil test, the program is free for residents.

More information at <http://www.co.prince-william.va.us/vce/enr/enr.htm>

WINSTON-SALEM, NC

Ultrafiltration for Pollution Prevention

Responsible Agency: Sara Lee Knit Products Corporation

Sara Lee Knit Products Corporation produces an array of finished textiles, many of which include cotton material dyed with reactive dyestuff. Cotton dyeing produces large waste streams, composed

mostly of color and salt. The dyestuff has a low affinity to the cotton fabric, even with the help of the salts used to bind the color to the fabrics. Almost all of the salt and approximately half of the dye ends up in discharges to the sewer system.

To reduce the amount of chemicals purchased and wastewater generated, Sara Lee Knit Products investigated a pilot-scale ultrafiltration and nanofiltration system. The filtration system separates the salts from other impurities for reuse and generates a concentrated color waste stream that can be more efficiently treated. The pilot study revealed that the system removes most pollutants of concern while allowing sodium chloride to remain in the permeate. Also, the polymer treatment scheme applied to the filtrate was successful and economical.

Projections from the pilot study suggest that the facility, which generates 240,000 gallons per day of wastewater, would reduce its water use by 120,000 gallons per day and salt discharges by 26,000 pounds per day. The filtration system will remove an estimated 60 percent of the dyestuff and 50 percent of the salt typically discharged. The total capital cost for the filtration and treatment system would be \$990,000 with annual operating costs of \$180,000. Savings on salt purchases were estimated at \$335,000 annually. An additional annual savings of \$460,000 could be achieved using the color removal process.

Contact: Donald Brown, Sara Lee Knit Products Corporation

References

EPA Office of Prevention, Pesticides, and Toxic Substances. 2002. "Definitions National Prevention Pollution Policy." Retrieved November 22, 2002.
<http://www.epa.gov/p2/p2policy/definitions.htm>.

EPA Office of Water. 1999. *Combined Sewer Overflow Management Fact Sheet: Pollution Prevention*. EPA 832-F-99-038.

Ferguson, T. *et al.* 1997. "Rouge River National Wet Weather Demonstration Project: Cost Estimating Guidelines Best Management Practices and Engineering Controls." Retrieved December 9, 2002.
<http://www.rougeriver.com/pdfs/stormwater/sr10.pdf>.

Land-of-Sky Regional Council. 2001. "Waste Reduction Partners Annual Report 2001." December 10, 2002. (Retrieved July 10, 2003.)
http://www.landofsky.org/publications/annual_report2001/default.htm.

Minnesota Pollution Control Agency (MPCA). 2002. "Household Hazardous Waste." Retrieved November 25, 2002.
<http://www.pca.state.mn.us/waste/hhw.html#map>.

North Carolina Division of Pollution Prevention and Environmental Assistance (NCDPPEA). 2002. "Considerations for the Management of Discharge of Fats, Oil, and Grease (FOG) to the Sanitary Sewer Systems." Retrieved November 22, 2002.
<http://www.p2pays.org/ref/20/19024.pdf>.

Northern Virginia Planning District Commission (NVPDC). 1996. *Nonstructural Urban BMP Handbook*. Prepared for the Department of Conservation and Recreation/Division of Soil and Water Conservation. Annandale, VA: NVPDC Coastal and Chesapeake Bay Program.

Inclusion of this technology description in this Report to Congress does not imply endorsement of this technology by EPA and does not suggest that this technology is appropriate in all situations. Use of this technology does not guarantee regulatory compliance. The technology description is solely informational in intent.



TECHNOLOGY DESCRIPTION

OPERATION & MAINTENANCE

Monitoring, Reporting, and Public Notification

Overview

Operation and maintenance practices are intended to enhance sewer system performance and minimize or reduce the occurrence of CSOs and SSOs and the potential impacts they have on receiving waters. Monitoring, public notification, and reporting of CSOs and SSOs and their impacts do not directly accomplish these objectives, but they are essential to:

- Understand sewer system performance and impacts of CSOs and SSOs on receiving waters;
- Provide the potentially impacted public with information about overflow locations, specific events, and performance trends;
- Improve oversight by the National Pollutant Discharge Elimination System (NPDES) authority; and
- Improve operations and maintenance (O&M) program efficiency.

Monitoring Techniques

Monitoring of both the sewer system and receiving waters provides valuable information for the operation and maintenance of sewer systems and the control of CSOs and SSOs. Monitoring provides knowledge of:

- The hydraulic characteristics of a sewer system and how it responds to a range of rainfall events; and
- The degree of impact caused by CSOs and SSOs on receiving waters.

Results from monitoring programs can also be used to track improvements associated with control efforts. The basic components of a monitoring program include:

- Rainfall;
- Sewer system flows and overflow frequency, duration and magnitude; and
- Water quality in both CSOs and SSOs and receiving waters.

Techniques for monitoring each of these components are briefly described below. Additional guidance on monitoring can be found in *Combined Sewer CSOs and SSOs: Guidance for Monitoring and Modeling* (EPA 1999).

Rainfall

Precipitation is the primary cause of CSOs and a major contributor to SSOs. Consequently, rainfall measurements are an integral part of a monitoring program.

Monitoring rainfall is fairly simple and provides valuable information in assessing the response of a sewer system to various rainfall events. Advanced techniques that merge radar data with rain gage data are available and can provide better rainfall estimates than either radar or a rain gage can provide alone.

Sewer System Flow

Flow measurements in the sewer system provide essential information related to the magnitude, duration, and frequency of CSOs and SSOs. This information can be used to design structural controls and to better operate and maintain the system, all in an effort to reduce CSOs and SSOs. Flow measurements following construction of controls and improved O&M practices can be used to assess the performances of controls and track improvements. Techniques for measuring flow in sewer systems vary greatly in complexity, expense, and accuracy.

Manual methods are the simplest technique for measuring flow and are most useful for instantaneous flow measurement or for determining whether or not an overflow occurred during or between measurements. Manual methods can be labor intensive and do not provide continuous flow records.

Primary flow devices control flow in a portion of a pipe such that the flow rate can be calculated from flow depth. Relationships between depth and flow are

accurate as long as surcharging or backflow does not occur. Manual or automatic measurements of the depth can be made. Depth-sensing devices can be used to measure water depth behind a primary flow device to determine flow rates.

Velocity meters use ultrasonic or electromagnetic technology to sense the velocity of flow in the sewer system. The velocity measurement is combined with a depth measurement from a depth-sensing device to calculate flow rates. Velocity meters can be used without the need for a primary flow device and in situations where surcharging or backflow occurs.

Pressurized flow rates can be estimated from the length of time pumps are on and the specifications for the pumps. Alternatively, full pipe flow can be measured using orifices, venturi flow meters, flow nozzles, turbines, and ultrasonic, electromagnetic, and vortex shedding meters.

Water Quality

Monitoring water quality in both the sewer system and receiving waters provides essential information for:

- Characterizing CSOs and SSOs
- Assessing the attainment of water quality standards
- Defining baseline conditions
- Assessing the relative impacts of CSOs and SSOs on receiving water quality

Water quality monitoring programs can also be used to track improvements associated with control efforts.

Data characterizing the water quality in the sewer system and receiving waters during both dry and wet weather conditions is needed. The water quality data can be analyzed to identify pollutants of concern, their concentrations, and likely sources of such pollutants. Pollutant concentrations along with sewer system flows can be used to calculate pollutant loadings to the receiving waters.

In addition to pollutant characteristics, monitoring in the receiving waters may include:

- Biological assessment (including habitat assessment)
- Sediment monitoring (including metals and other toxics)
- Flow conditions

In many cases, the primary parameter of concern with respect to CSOs and SSOs will be pathogens,

represented by an indicator bacteria such as fecal coliform or *E. coli*. Observations of floatables, objectionable deposits, or algal growths may also provide relative measures of CSO and SSO impacts. Two distinct types of water quality samples can be collected:

- Grab samples: a discrete, individual sample representing the conditions at one location at the time the sample is taken.
- Composite samples: a combination of samples collected over a period of time from one location or combination of samples from more than one specific location.

Grab and composite samples can be collected using either manual or automatic sampling methods. Manual samples are collected by a trained individual using a hand-held container. Automated samplers can be programmed to collect multiple discrete samples as well as single or multiple composited samples. Many automated samplers can be connected to flow meters that will activate flow-weighted compositing programs, and some samplers are activated by inputs from rain gages.

A Quality Assurance Project Plan (QAPP) is an essential component of any monitoring program to ensure precise, accurate, and reliable data. EPA guidance for the development of a QAPP should be followed (EPA 2002c). The QAPP should address field sampling methods and protocols as well as laboratory analytical methods and quality assurance/quality control (QA/QC). Data management techniques and responsible personnel should also be addressed in a QAPP.

Public Notification

Public notification programs provide information to the potentially impacted community regarding the occurrence of CSO and SSO events and on-going efforts to control the discharges. The Nine Minimum Controls (NMC) outlined in EPA's CSO Control Policy specifically require implementation of a public notification program to ensure that the public receives adequate notification of CSO occurrence and CSO impacts. Public notification programs can assume a variety of forms, including posting temporary or permanent signs where CSOs and SSOs occur (Figure 1), coordinating with civic and environmental organizations, distributing fact sheets to the public and the media, and stenciling storm drains. Notices in newspapers are required to report occurrences of CSOs or SSOs in some states. Radio and TV announcements may be appropriate for CSOs or SSOs with unusually severe impacts. Distribution

of information on websites is another technique that is rapidly gaining wider use.

Posting Signs

Signs are one of the most common mechanisms used to communicate the potential hazard posed by CSO and SSO discharges. Signs can be posted in the area where the use is affected (e.g., along a beach front) or at select public places (e.g., a public information center at a park where recurrent SSOs have occurred). EPA specifically recommends posting at visible CSO outfalls and in locations where affected shoreline areas are accessible to the public. In addition to notifying the public of the potential risk of exposure to CSO or SSO discharges, signs may provide contact information for citizens interested in obtaining additional information or to submit concerns. Call centers may be established to receive sign-prompted calls.



Figure 1. CSO warning sign (King County, WA)

Coordinating with Civic Organizations

There are a number of ways that a municipality can involve public interest or civic and environmental groups in various aspects of programs to control CSOs and SSOs. One way is to involve the public in the process of evaluating technologies for controlling CSOs and SSOs. Involvement in assessing willingness to pay, determining the implementation schedule, and selecting or modifying the method of financing for the controls are other ways to involve these groups. Public meetings or hearings allow public interest or civic groups to officially comment or pose questions to the municipality regarding a control program.

For example, the State of Wisconsin organized a workgroup including representatives from state and local health departments and citizen groups with an interest in beach health. This group worked to gather data on beach use and potential sources of contamination. They also interviewed beachgoers and collected suggestions for improvement of beach health. As a result of this program, Wisconsin's 180 coastal beaches were categorized into high, medium, and low priority based on popularity and risk of contamination by sources including CSOs and SSOs. Higher priority beaches are tested more frequently, including 25 high-priority beaches that are tested five times per week. Every day, the high-priority beaches post one of three signs to advise beachgoers of water quality for that day – good, poor, or closed. In addition, bathers can also check a website to view daily water quality reports for all high-priority beaches along the Great Lakes.

Distributing Fact Sheets

Another method of outreach to the public is through the dissemination of fact sheets on CSOs and SSOs. Municipalities often use these fact sheets to describe what CSOs or SSOs are, address specific local issues, and discuss impacts to local water bodies. Local issues addressed in the fact sheets can include disconnecting downspouts from the sewer system, local monitoring programs, and system improvements that are planned or are being implemented to address CSOs and SSOs. Fact sheets can also be developed to target specific commercial or industrial sewer customers encouraging best management practices, explaining regulatory requirements, or highlighting important pollution prevention measures.

EPA's Office of Wastewater Management has also developed a series of outreach materials and fact sheets to help municipalities educate citizens on important wastewater issues. These materials are available online at: <http://cfpub.epa.gov/npdes/wastewatermonth.cfm>. The materials include space to insert local contact information for citizens to find more information. Local governments can inexpensively produce custom versions of the materials with their own addresses and phone numbers.

Stenciling Storm Drains

Storm drain stenciling is frequently used in separate storm sewer systems to educate the public that wastes disposed of in storm drains flow directly to receiving waters without treatment. Similarly, municipalities with CSSs can use storm drain stenciling as part of a public

education program (Figure 2). Stenciling the name of the water body to which the street inlet drains provides a concrete link to the public to the consequences of dumping or littering. Storm drain stenciling programs can also generate useful information for the municipality. Since cities often have more storm drain inlets than can be efficiently inspected by city staff, program volunteers may be asked to note drains that



Figure 2. Community education on the importance of storm drain stenciling (King County, WA)

are clogged with debris or show signs of dumping. The municipality can then target these drains for maintenance.

Reporting

An essential element of a proper O&M program is documentation of accurate and reliable records related to CSOs and SSOs. Reporting requirements related to CSO and SSO events are typically included in the NPDES permit issued to a wastewater utility. Current reporting requirements for CSOs and SSOs are not always consistent from state-to-state; however, reporting typically involves notifying the appropriate regulatory agencies in a timely manner after a CSO or SSO event. Several states require that the duration and frequency of every CSO event be reported in a discharge monitoring report and submitted on a monthly basis. Twenty-four hour oral reporting of SSO events is generally required, and must be followed by a written report within five days of the SSO event. States may also require an annual report estimating the volume of CSO or SSO discharged over the past year, identifying known or potential water quality impacts, and, in the case of SSOs, the cause of the spill. Several states compile information

on reported SSO events in databases or spreadsheets; at least two states, Michigan and Maryland, publish lists of reported CSO and SSO events on their websites.

The CSO Control Policy states that the municipality should submit to the NPDES permitting authority documentation on the implementation of the NMC. Documentation should include information that demonstrates:

- The alternatives considered for each minimum control
- The actions selected and the reasons for their selection
- The selected actions already implemented
- A schedule showing additional steps to be taken
- The effectiveness of the minimum controls in reducing/eliminating water quality impacts.

The *Guidance for Nine Minimum Controls* (EPA 1995) presents examples of the information that should be documented for the NMCs.

Key Considerations

Responsibility for monitoring, public notification, and reporting efforts is often shared by a number of agencies within a single jurisdiction. These can include:

- Wastewater utility operators
- City, county, or state health department
- City, county, or state environmental agencies
- Drinking water providers
- Public works departments

This potential overlap can lead to a duplication of efforts (e.g., multiple agencies monitoring water quality conditions in a single location). Good communication between these agencies can help ensure cost-effective data collection and a coordinated response to those CSO and SSO events with potential to impact the environment or human health. Other key considerations related specifically to monitoring, public notification, and reporting are discussed below.

Monitoring

Developing the extent of the monitoring program and selecting the most appropriate monitoring techniques will depend on site characteristics, budget constraints, and availability of trained personnel. The development of the monitoring program should be closely coordinated with the NPDES permitting authority to make sure that monitoring results will be acceptable and satisfy the regulatory requirements. Some specific considerations for monitoring rainfall, sewer system flow, and water quality are discussed below.

Rainfall

Rainfall conditions may vary significantly over a sewer system. Sufficient rain gages should be located to provide data representative of the entire study area. Rain gages should be located in open spaces away from trees or buildings that may shield the gage from rainfall. Installing the gages at ground level is preferred, rooftops are also an option. Police and fire stations and other public buildings are desirable locations as vandalism is prevented.

Sewer System Flow

Monitoring flows in sewer systems can be difficult because of surcharging, backflow, tidal flows, and the intermittent nature of CSOs and SSOs. Although some metering installations are designed to operate automatically, they are prone to clogging in sewer systems and should be checked as often as possible.

Monitoring locations should be selected to identify which structures in the sewer system limit hydraulic capacity and should target portions of the system that are most likely to have CSOs and SSOs or receive significant pollutant loadings. A representative range of land uses and basin sizes should be monitored. As many overflow outfall locations as possible should be monitored with an emphasis on discharges to sensitive areas. Flow measurement devices can be rotated between locations to obtain more comprehensive coverage of the sewer system.

For CSOs and SSOs dependent on rainfall, a sufficient number of storms should be monitored to accurately predict the sewer system's response to a range of rainfall conditions.

Water Quality

Flow-weighted composite samples should be collected from the sewer system or outfalls to determine the average pollutant concentration from an overflow event (also known as the event mean concentration or EMC). Discrete samples from the same location over the course of an overflow can help determine whether a pattern of pollutant concentration exists, such as a first-flush phenomenon. A range of rainfall events and receiving water conditions should be monitored.

In developing a water quality monitoring plan, the location and impacts of all sources of pollutant loadings should be considered, and monitoring locations should be selected to isolate the impacts from CSOs and SSOs as best as possible. Monitoring to characterize the pollutant loadings from sources other than CSOs and SSOs may be needed. Sensitive areas

should be given priority for monitoring, such as waters with drinking water intakes or recreational uses. The implementation of water quality monitoring programs should be a high priority at beaches or recreational areas directly or indirectly affected by CSOs and SSOs due to the increased risk of human contact with pollutants and pathogens. Finally, the safety and accessibility of monitoring locations should be given consideration.

One of the key considerations related to conventional water quality monitoring is the lag time between collecting water samples and providing the public with results. This lag is due to the time it takes (from 24 to 72 hours) to test for the presence of bacterial indicators of CSO or SSO contamination. During this time, pathogen levels, weather, and water conditions may change, and related environmental or human health risks may also change. This means that decisions regarding beach and recreational water postings, closings, and reopenings using bacterial indicators often reflect conditions as they were one to three days earlier (EPA 2002). Further, contaminants may no longer be present once test results are available and safe beaches may be posted needlessly. Recent studies of southern California beach closures showed that 70 percent of the postings of water quality exceedences last less than one day, meaning that water quality is likely to have already returned to acceptable levels by the time laboratory results are available and warning signs are posted (Leecaster and Weisberg 2001).

To address this time lag problem, a number of municipalities are using time-relevant water quality monitoring and receiving water quality models. These techniques seek to shorten analysis times, use quicker predictive methods, and communicate water quality information to the public on a timely (e.g., near-daily) basis so the public can make more informed decisions regarding recreational water use (EPA 2002). Specific activities undertaken to support these objectives include monitoring more frequently or at additional locations, using analytical methods that provide results sooner, using a predictive model to supplement monitoring, and improving public notification programs.

Public Notification

The principal advantage of a public notification program is the potential to reduce exposure of the general public to health risks associated with exposure to CSOs and SSOs. Well-designed public notification programs also offer wastewater utilities an opportunity to educate customers and seek assistance from the public in identifying problems,

such as dry weather CSOs and SSOs. It can be challenging, however, to interest and involve the public in municipal efforts to control CSOs and SSOs.

Public notification programs may be developed cooperatively with other agencies and organizations including city, county, or state health departments; shoreline owner associations; boating and fishing associations; or local planning and zoning authorities. Cooperative efforts can be a valuable mechanism for leveraging resources, as well as enhancing the quality, credibility, and success of public notification programs (EPA 2002). Experience shows that it may also be valuable for the wastewater utility to establish a relationship with the local media to help promote efforts to control CSO and SSO events, as well as to distribute time-relevant recreational water quality information. More extensive experience working with the local news media can also help ensure minimal misinterpretation regarding the occurrence of CSO and SSO events.

The public is often not interested in the details behind the monitoring project, but rather if the water body is safe to use. Therefore, it is important that information is disseminated in a clear and concise format so that the public can consider the relative risk associated with exposure to the water body. Unless beachgoers are informed about current water quality conditions in a particular area, they will be unable to make informed choices about destinations or how to avoid exposure to pollutants, if necessary.

Reporting

The timely reporting of CSO and SSO events is a regulatory requirement; therefore, penalties are assessed for failing to report. It is important to maintain regular communication with the regulatory authority to ensure that submissions comply with permit requirements and meet the expectations of the permitting authority.

As municipalities, NPDES permitting authorities, and the public undertake efforts to control CSOs and SSOs, consideration should be given to developing and reporting on performance measures such as:

- End-of-pipe measures that show trends in the discharge of CSOs and SSOs, such as reduction in

pollutant loadings and the frequency, duration, and magnitude of CSOs and SSOs;

- Receiving water measures that show trends in relevant water quality parameters, such as bacteria and dissolved oxygen concentrations; and
- Measures of the use of the receiving waters including beach closures, shellfish bed closures, and fish populations.
- Administrative measures that track programmatic activities;

Reporting on performance measures will allow municipalities, states, and EPA to demonstrate the benefits and long-term success of CSO and SSO control efforts.

Cost

The cost of monitoring will vary greatly based on the size and complexity of the sewer system and receiving waters, the number of CSO and SSO events that occur, and the techniques used. The costs of monitoring can be significant, especially for a large sewer system, a large number of outfalls, or frequent occurrences of CSO or SSO events. A small scale monitoring program may necessitate more conservative assumptions or result in more uncertainty when reporting on overflow events and when selecting and designing CSO or SSO controls. It should be noted that large sums of money spent on monitoring should be avoided if the additional data will not significantly enhance understanding of how a sewer system responds to a range of rainfall events, and to what extent receiving waters are impacted by CSOs and SSOs.

Analysis of water samples for the presence of indicator bacteria typically costs about \$35 per sample (EPA 2003). Bacteria data tend to be highly variable; therefore, samples may need to be collected in duplicate or triplicate from a single location. Additionally, if a CSO or SSO event occurs over an extended period of time, multiple samples may need to be collected over time.

EPA believes that, in general, costs for public notification programs should be nominal (EPA 1995), but will vary with the size of the potentially-impacted population. Costs for reporting should be nominal as well, if a well-designed O&M plan is carried out.

Implementation Examples

NARRAGANSETT BAY, RI

Responsible Agency: Rhode Island Department of Health
Population Served: 360,000

CSOs have historically caused use restrictions in large areas of the upper Narragansett Bay. There are several beach areas in the upper bay that are used by the public for swimming, diving, and water skiing. The

occurrence of recreational use in areas with use restrictions is a public health concern.

To address this public health issue, the Rhode Island Department of Health's (RIDOH's) Beaches Monitoring Project samples 23 sites in the upper bay. RIDOH conducts weekly beach monitoring from mid-May through mid-September to coincide with the summer beach season. Beaches are closed based on exceedances of bacterial water quality standards. RIDOH also closes beaches preemptively, without waiting for sampling results, if a CSO or SSO occurs near a beach. If a beach is closed because of high bacteria levels, it is resampled daily until bacteria levels fall below the water quality criteria. The beach is reopened if five consecutive samples are collected at least 24 hours apart that are at or below the bacterial water quality standard. Upon reopening, at least three samples are collected each week for three months. The public is notified of beach closures using the following procedures:

- Appropriate municipal and state officials are notified
- An advisory or closure notice is posted at the beach, as needed
- A press release is issued and the project website and hotline are updated with current conditions

Many of these sites sampled were found to display consistently poor water quality, exceeding the state bacteria standard more than 50 percent of the time.

More information at: <http://www.health.state.ri.us/environment/beaches/index.html>

KING COUNTY, WA

Responsible Agency: King County Wastewater Treatment Division
Population Served: 1.3 million
Service Area: 420 sq. mi.
Sewer System: 275 mi. of sewer

The King County Wastewater Treatment Division works jointly with the Seattle Public Utilities and the Seattle-King County Health Department in posting warning signs at CSO locations and undertaking public outreach. The Health Department maintains a CSO information line and website to answer any health concerns about CSOs or questions such as, "How long does water stay contaminated after a discharge?" In early 1999, King County and the City of Seattle posted signs near CSO outfalls. The signs warn people

not to swim or fish at these outfalls during or following rainstorms. The signs also include the phone number of the CSO Information Line operated by the Seattle-King County Health Department. The Health Department recommends that people not go in the water near these signs for 48 hours after a heavy rain.

Contact: Bob Swarmer, King County Wastewater Treatment Division

PITTSBURGH/ ALLEGHENY COUNTY, PA

Responsible Agency: Allegheny County Health Department

Population Served: 850,000

Service Area: 311 sq. mi.

Sewer System: 85 mi. of interceptor sewer

The Allegheny County Health Department (ACHD) implemented a public notification program designed to warn the public of possible river contamination as a result of CSO events, and advise limited contact while engaging in recreational activities on the river during periods immediately following wet weather events. The frequency and duration of the alerts varies depending on the amount of

rainfall. ACHD publishes river water advisories in local newspapers and produces public service announcements on local television stations to educate the public of the dangers attributable to the CSO discharges. When an alert is in effect, marinas, docks, and other sites along the rivers fly an orange-colored flag with black CSO lettering. Thirty-four sites participated in the program during the 2003 recreation season - seventeen on the Allegheny River, eight each on the Monongahela and Ohio Rivers, and one on the Youghiogheny River. The flags are lowered when "safe" levels have returned. The public can also call the river water advisory hotline or visit the ACHD website to obtain updates 24 hours a day.

Thirteen alerts were issued during the wet summer of 2002, lasting 83 days altogether or an average of six days each. By contrast, during the dry summer of 1999, 11 alerts were issued and lasted a total of 33 days or an average of three days each.

More information at <http://www.achd.net/>

BOSTON, MA

Responsible Agency: Charles River Watershed Association, Metropolitan District Commission, and Massachusetts Water Resources Authority

One of the monitoring objectives of the Charles River Basin/Boston Harbor Beaches Project was to develop a predictive model that would supplement the water quality monitoring program and provide quick, conservative estimates of bacteria levels at four Boston Harbor beaches. The four beaches are sampled seven times per week; rain gages have been installed close to the beaches.

Analysis of data collected at the beaches showed that the previous day's rainfall was a better predictor of water quality than the previous 24-hour bacteria measurement. Therefore, a simple rainfall model was developed for each of the beaches, and combined results from the rainfall model and bacteria monitoring are used to determine when to post the beaches. Beaches are reopened only when monitoring results indicate attainment of the bacterial water quality standard. The project uses several different types of public notification techniques to communicate the results of the monitoring program. These include:

- Availability of daily water quality conditions on the Metropolitan District Commission website
- A telephone hotline that provides updated water quality conditions for Boston Harbor beaches on a daily basis throughout the beach season
- Posters, water bottles, and brochures that explain and highlight the beach monitoring program
- Notification and other communications with the Massachusetts Department of Public Health and local boards of health

More information at <http://www.crwa.org>

References

- Allegheny County Health Department. "Topic: Water Pollution - Surface and Underground Sources of Water." Retrieved June 3, 2003. <http://trfn.clpgh.org/achd/sewage.html>.
- Bartram, J., and G. Rees, eds. 2000. *Monitoring Bathing Waters: A Practical Guide to the Design and Implementation of Assessments and Monitoring Programmes*. London and New York: E&FN SPON.
- Boehm, A.B., et. al. 2002. Decadal and shorter period variability and surf zone water quality at Huntington Beach, California. *Environmental Science and Technology*. 36:3885-3892.
- Citizens Environmental Research Institute (CERI). 1999. *Assessment Strategy for Evaluating the Environmental and Health Impacts of Sanitary Sewer CSOs and SSOs from Separate Sanitary Sewers*. EPA Cooperative Agreement CX-824848-01-1.
- EPA Office of Water. 1995. *Combined Sewer CSOs and SSOs: Guidance for Nine Minimum Controls*. EPA 832-B-95-003.
- EPA Office of Wastewater Management. 1999. *Combined Sewer CSOs and SSOs: Guidance for Monitoring and Modeling*. EPA 832-B-99-002.
- EPA Office of Water. 2001. *Report to Congress: Implementation and Enforcement of the Combined Sewer Overflow Control Policy*. EPA 833-R-01-003.
- EPA Office of Water. 2001a. *Source Water Protection Practices Bulletin: Managing Sanitary Sewer CSOs and SSOs and Combined Sewer CSOs and SSOs to Prevent Contamination of Drinking Water*. EPA 916-F-01-032.
- EPA Office of Research and Development and Office of Water. 2001. *National Coastal Condition Report*. EPA 620-R-01-005.
- EPA Office of Research and Development. 2002a. *Time-Relevant Beach and Recreational Water Quality Monitoring and Reporting*. EPA 625-R-02-0017.
- EPA Office of Water. 2002b. *National Beach Guidance and Required Performance Criteria for Grants*. EPA-823-B-02-004.
- EPA Office of Environmental Information. 2002c. *Guidance for Quality Assurance Project Plans (EPA QA/G-5)*. EPA 240-R-02-009.
- EPA Office of Water. 2003. Guidelines establishing test procedures for the analysis of pollutants; analytical methods for biological pollutants in ambient water: Final rule. *Federal Register* 68, no. 139, July 21, 2003.
- King County Department of Natural Resources and Parks Wastewater Treatment Division. "The CSO Control Program." Retrieved June 3, 2003. <http://www.dnr.metrokc.gov/wtd/cso/page02.htm>.
- King County Department of Natural Resources and Parks Wastewater Treatment Division. March 2002. "Regional Wastewater Services Plan - Water Quality Report." Retrieved October 1, 2003. <http://dnr.metrokc.gov/wtd/rwsp/documents/WQ2002.pdf>.
- King County Department of Natural Resources and Parks Wastewater Treatment Division. 2002. "2001/2002 Combined Sewer Overflow Report." Retrieved October 1, 2003. <http://dnr.metrokc.gov/WTD/cso/2001-02-intro.htm>.
- Leecaster, M.K., and S.B. Weisberg. 2001. Effect of sampling frequency on shoreline microbiology assessments. *Marine Pollution Bulletin* 42:1150-1154.
- Southern California Coastal Water Research Project (SCCWRP). 2003. "Research Plan 2003-2004." Retrieved July 7, 2003. <http://www.sccwrp.org/about/rspln2003-2004.html>.

Inclusion of this technology description in this Report to Congress does not imply endorsement of this technology by EPA and does not suggest that this technology is appropriate in all situations. Use of this technology does not guarantee regulatory compliance. The technology description is solely informational in intent.



TECHNOLOGY DESCRIPTION

Collection System Controls

Maximizing Flow to Treatment Plant

Overview

Maximizing the amount of wet weather flow transported to the wastewater treatment plant (WWTP) is a common technique for reducing the volume and frequency of CSO and SSO discharges. Maximizing the use of existing facilities to treat wet weather flows that would otherwise overflow without treatment is constructive in all circumstances. The various technologies available for maximizing the amount of flow conveyed to the WWTP include minimum measures that can be implemented without capital investment, and more capital intensive projects that require planning, design, and construction.

Maximizing flow to the WWTP is one of the nine minimum controls (NMC) established under EPA's 1994 CSO Control Policy. As an NMC, maximization of flow to the WWTP includes measures that do not require significant engineering studies or major construction. Simple modifications to existing facilities such as adjustment of regulators to divert more flow to the WWTP can be done rather inexpensively. The CSO Control Policy

also encourages municipalities to consider use of WWTP capacity for CSO control as part of developing a long-term control plan (LTCP). In doing so, municipalities may consider more capital intensive measures to maximize the wet weather flow delivered to the WWTP, including pump station enhancements and construction of relief sewers in areas with insufficient system capacity.

Many of the techniques for maximizing flow to the WWTP specifically referenced and expected for combined sewer systems (CSSs) have broad utility and can also be applied to sanitary sewer systems (SSSs). EPA recommends that the measures listed in Table 1 be considered as part of any effort to maximize flow to the WWTP (EPA 1995).

Effective implementation of controls to maximize flow to the WWTP requires a thorough understanding of the sewer system and how it functions during wet weather. This often includes a concurrent assessment of the sewer system and treatment plant operations to ensure that increased flows do not have adverse consequences, such as flooding within the system or at the WWTP, or upset of biological

Table 1. Considerations in maximizing flow to the WWTP.

Location	Measures
Sewer System	Determine the capacity of the major interceptor(s) and pumping station(s) that deliver flows to the treatment plant.
Treatment Plant	<p>Develop cost estimates for any planned physical modifications and any other additional operations and maintenance (O&M) costs at the treatment plant due to increased wet weather flow.</p> <p>Compare the current flows with the design capacity of the overall facility, as well as the capacity of individual unit processes. Identify the location of available excess capacity.</p> <p>Determine the ability of the facility to operate acceptably at incremental increases in wet weather flows and estimate the effect on the WWTP's compliance with the effluent limits in its permit. For example, increased flows may upset biological processes and decrease performance for an extended period after the wet weather flows have subsided.</p> <p>Determine whether inoperative or unused treatment facilities on the WWTP site can be used to store or treat wet weather flows.</p> <p>Analyze existing records to compare flows processed by the plant during wet weather events and dry periods and determine the relationships between performance and flow.</p>

treatment processes. This technology description is focused on the modifications and operational changes within the sewer system. Specific measures discussed include:

- Regulator adjustments
- Pump station operation and maintenance practices
- Sewer system operation and maintenance practices
- Conveyance capacity evaluations
- Real-time control and monitoring

Additional information on optimizing WWTP performance during periods of wet weather is presented in the “Plant Modifications Technology Description” in Appendix B of the 2003 *Report to Congress on the Impacts and Control of Combined Sewer Overflows and Sanitary Sewer Overflows*.

Regulator Adjustments

Simple modification to regulating devices in CSSs, such as weirs, can be useful in maximizing flow to the WWTP. Adding stop planks or raising brick/concrete weirs through the construction of either temporary or permanent structures, can increase the volume of wet weather flows stored in the CSS and eventually delivered to the WWTP for treatment. Such modifications should be made incrementally with careful observation of resultant changes in wet weather flow patterns in the CSS to prevent flooding.

Pump Station Operation and Maintenance Practices

Routine pump station O&M can also improve the conveyance of wet weather flows to the WWTP; this includes regular maintenance of pumps and accessories, as well as periodic cleaning of wet wells to remove grit, scum, and debris. Where emergency generators are provided, generators should be exercised weekly (NYSDEC 2003). Automatic transfer switches for transferring power from emergency generators or backup utility power feeds should be tested and exercised periodically. To be sure that all equipment is ready for service when wet weather arrives, regular maintenance of all equipment should be provided in accordance with the manufacturer’s recommendations. In addition to routine O&M, more detailed assessment of pump station performance can be made to ensure that the maximum flow is delivered to the WWTP. These include evaluating whether the pumps are currently able to achieve their rated pumping capacities and whether improved wet weather operating procedures would increase the flow volume delivered to the WWTP. Rehabilitation or replacement should be considered for pumps that are no longer able to achieve their rate pumping capacity. Wet weather operating

procedures can include adjustment to pump stations and their control systems to increase in-system storage during wet weather. For example, if the inlet sewer to the pumping station is not normally submerged and has available storage capacity, pump controls can be adjusted to allow the wet well level to rise above the feed pipe elevation, resulting in storage in the sewer system (NYSDEC 2003).

Sewer System Operation and Maintenance Practices

Operations and maintenance activities are necessary for sewer systems to function as designed and to deliver the maximum flow possible to the WWTP. Over time, sewer systems can deteriorate structurally or become clogged through the introduction of oil and grease and other obstructions into the sewers. Grit buildup reduces the hydraulic capacity of sewers and interceptors by reducing the cross-sectional area and increasing frictional resistance.

O&M practices include pollution prevention, sewer cleaning, monitoring, testing, inspection, and repair or rehabilitation. These activities enhance sewer system performance and are important for maintaining conveyance capacity. Some states include specific O&M requirements in NPDES permits for sewer systems in order to maximize the transport of wet weather flow to the WWTP for treatment. For additional information on proper O&M, see the series of O&M Technology Descriptions in Appendix B of the 2003 *Report to Congress on the Impacts and Control of Combined Sewer Overflows and Sanitary Sewer Overflows*.

Conveyance Capacity Evaluations

Quantifying sewer system transport capacity is valuable for communities seeking to maximize flow to their WWTPs. Evaluating transport capacity involves determining the maximum amount of flow that can be transported by the primary trunk sewers and interceptors without raising water elevations in these sewers to levels which increase the risk of basement or street flooding (Sherrill *et al.* 1997).

Models, varying from simple to complex, are commonly applied to rate a sewer system’s transport capacity. Historical information can be used to identify target water levels within the system that do not cause problems such as SSOs, basement backups, or street flooding. Transport capacity is determined through evaluation of modeled flows at flow rates less than or equal to the target water levels. Interceptor sewers and trunk lines are usually rated separately.

It is important to consider site-specific characteristics of the sewer system when evaluating conveyance capacity. Conveyance of flow through a sewer is dependent on the difference in water level from the upstream to the downstream end, pipe slope, sewer size (length, shape, and cross-sectional area), and roughness characteristics. Under ideal conditions, a single sewer pipe may be able to convey flow at its entire capacity. However, real-system boundary conditions such as river elevations, downstream sewer capacities, regulator capacities, and pump station wet well levels will affect the transport of flow (Sherrill *et al.* 1997).

The presence of bottlenecks in a sewer system is also an important consideration in conveyance capacity evaluations. Bottlenecks may occur at any point in the sewer system; they limit the amount of flow that can be transported to the WWTP for treatment during periods of high flow. Chronic bottlenecks typically occur as a result of insufficient interceptor capacity that causes flow to backup in connecting sewers. An example of a bottleneck resulting from insufficient interceptor capacity during a wet weather event is presented in Figure 1. As shown, the hydraulic response to the bottleneck is a decrease in flow velocity and an increase in water level. In acute situations, water levels increase until they rise above an overflow point (in this case the manhole rim) and an SSO occurs (ASCE 2000). Both velocity and water level return to normal once the high wet weather flow rates subside.

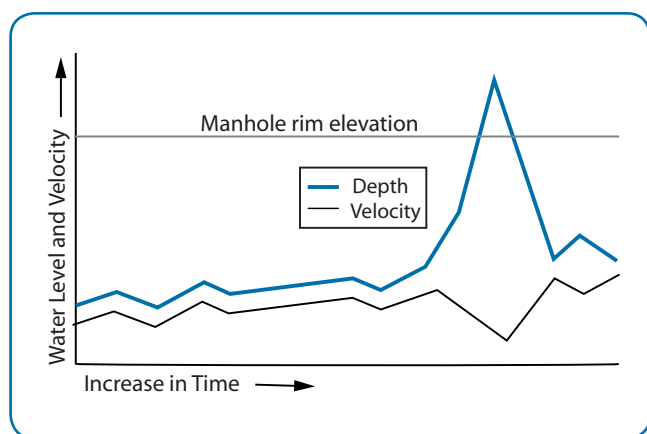

Figure 1. Schematic showing water levels and velocity conditions at a manhole when a bottleneck occurs (ASCE 2000).

Bottlenecks may also occur when the sewers delivering flow to the WWTP have less capacity than the individual unit processes at the plant. For example, if interceptors leading to the WWTP have a conveyance capacity of 50 MGD, yet unit processes (e.g., primary

treatment, secondary treatment, and disinfection) at the plant can treat 75 MGD, a hydraulic bottleneck exists in the sewer system. This bottleneck prevents the treatment capacity of the plant from being fully utilized. In order to maximize flow to the WWTP, bottlenecks need to be reduced or removed. Potential modifications include (Field *et al.* 1994):

- Increasing interceptor, pumping station, and/or trunk line transport capacity by replacing, rehabilitating, or adding parallel sewer components;
- Injecting polymers into the sewer system to reduce sewer roughness and increase carrying capacity in surcharged areas; and
- Improving operations and management procedures to remove obstructions.

Real-Time Control and Monitoring

Monitoring and the use of real-time control technologies can also assist in maximizing flows to the WWTP. An effective monitoring program that gathers information on rainfall, flow, and storage at major hydraulic control points enhances the overall understanding of system performance. In SSSs, enhanced monitoring information can be used operationally to identify blockages or rainfall induced SSOs. In CSSs, the linkage of real time flow, regulator, pump, and storage information can be used effectively to maximize use of the sewer system for storage and to maximize flow to the WWTP for treatment. Additional information on real-time control technologies is presented in the “Monitoring and Real-Time Control Technology Description” in Appendix B of the 2003 Report to Congress on the Impacts and Control of Combined Sewer Overflows and Sanitary Sewer Overflows.

Key Considerations

Applicability

Maximizing flow to the WWTP requires attention to both regulatory issues (e.g., NPDES permit requirements) and technical considerations (i.e., conveyance and treatment capacity). WWTPs are generally subject to EPA’s secondary treatment regulations. Secondary treatment requirements specify effluent concentration limits for biochemical oxygen demand (BOD) and total suspended solids (TSS), as well as a minimum removal percent (85 percent). These requirements are enforceable conditions in WWTP permits. The regulations provide some flexibility for WWTPs in communities receiving elevated flows (and more dilute influent) during wet weather by allowing for waivers of the

percent removal requirement. Waivers are not available, however, from effluent concentration limits (EPA 1995). Therefore, the optimal volume of wet weather flow transported to the plant may be constrained by provisions in existing discharge permits and the ability to modify provisions for increased flows during wet weather events.

Understanding the link between sewer system and WWTP operation can be the difference between effective treatment of wet weather flows and adverse environmental and financial consequences. Operational and structural modifications to maximize flow transport to the WWTP should only be made if the WWTP can accept the increased flows. Otherwise, consequences may include flooding the treatment plant and reducing treatment efficiency at the plant for extended periods of time. Likewise, changes in sewer system operation without a careful analysis of transport capacity could result in an increase in basement

backups or street flooding. For these reasons, both sewer system and WWTP capacity issues should be evaluated when implementing this control (see Table 1).

Cost

Maximization of flow to the WWTP can be a very cost-effective technique for controlling CSOs and SSOs. This control seeks to optimize use of existing sewer system and treatment plant capacity, which can lessen the need for construction of new facilities. The value of maximizing flow to the WWTP is dependent on the system-specific availability of underutilized conveyance and treatment capacity. Although some cost increases can be expected for WWTP operation, optimizing the use of existing facilities is likely to be more cost-effective than construction of structural controls at one or more upstream locations.

Implementation Examples

PHILADELPHIA, PA

Responsible Agency: Philadelphia Water Department

Population Served: 2.1 million

Service Area: Not Available

Sewer System: 1,600 mi. of combined sewer; 1,200 mi. of separate sanitary and storm sewer

Maximizing Conveyance Capacity

The first phase of the Philadelphia Water Department (PWD) CSO strategy focused on the implementation of the nine minimum controls (NMC), including increasing the transport of flow to the WWTP for treatment. To garner information for PWD's NMC program (and eventually the long term control plan), PWD instituted a \$6.5 million project to upgrade its comprehensive system flow monitoring network in its three drainage districts. This flow

monitoring program provided information to monitor system performance and enhance operation of the system through existing infrastructure (PWD 1997).

PWD also took steps to maximize flow to their wastewater treatment facilities in the second phase (capital improvement) of their CSO program. For example, analysis of the Northeast Drainage District Collector System, which conveys flow from almost half of the combined sewer area, showed that sewer operation modifications could significantly increase the volume of wet weather flow transported for treatment. Potential modifications included (1) reduction of hydraulic constraints in the system that limit the conveyance capacity of the sewers; and (2) modification of large sewers to provide additional wet weather flow storage and conveyance capacities.

PWD has implemented a range of projects to maximize conveyance to their treatment plants including adding a real-time control system, replacing pipes and raising dams at regulators, and cleaning and modifying the hydraulic control point regulators along the main level gravity sewers. A major goal of PWD's LTCP strategy also includes optimizing interceptor sewer system performance by maximizing the conveyance capacity of existing interceptors. Example projects are provided below.

- *Somerset Interceptor Conveyance Improvements:* Removal of grit, sediment, and debris from the interceptor enabled the full hydraulic capacity of the interceptor to be utilized, allowing for increased capture and representing an approximately 10 percent reduction in CSO volume. The project budget was \$300,000.
- *Cobbs Creek Low Level Control Projects:* Grit accumulation reduced the hydraulic capacity in an interceptor that conveys flow to the low-level pumping station. The grit was removed; flow was also rerouted with a 30-inch pipe, increasing the capacity from 11.8 MGD to 15 MGD. This project was completed at a cost of \$200,000.

More information at <http://www.phila.gov/water/>

DETROIT, MI

Responsible Agency: Detroit Water and Sewage Department

Population Served: 3 million

Service Area: 921 sq. mi.

Sewer System: 3,000 mi. of sewer

Assessing Transport Capacity

The WWTP for the City of Detroit receives wastewater via three interceptors. The city conducted an extensive study which rated its sewer system for both conveyance and storage of combined sewage. Rating the conveyance capacity involved determining the maximum amount of flow that can be transported by the primary trunk sewers and interceptors without raising water elevations in these sewers to levels that increase the risk of basement or street flooding. Historical information was used to

establish these water levels throughout the CSS. In addition, design data at specific locations were used, and detailed risk evaluations were conducted at specific locations in the system.

System rating included use of the Greater Detroit Regional Sewer System model to simulate flow throughout the sewer system for a range of storm events. Target water levels determined from the historic information were compared against the resulting water levels produced by the model. Flow rates, which predicted water levels equal to or less than target water levels, were used to establish the transport ratings. Trunk sewers and four interceptor sewers were rated separately (Sherrill *et al.* 1997).

More information at http://www.wadetrin.com/resources/pub_conf_collrate.pdf

BOSTON, MA

Responsible Agency: Massachusetts Water Resources Authority

Population Served: 2.5 million

Service Area: 228sq. mi.

Sewer System: Not Available

Elimination of Bottlenecks and System Optimization

Massachusetts Water Resources Authority's (MWRA) CSO plan was developed as part of an overall master plan that recommended interceptor system projects to eliminate bottlenecks that contribute to CSOs and to optimize existing facility operation during wet weather. Between 1988-2000, several transport-related projects were conducted to maximize wet weather flow conveyance to Deer Island Treatment Plant. This included rehabilitation of trunk sewers, improved pumping at Deer Island Treatment Plant, replacement of other pump stations within the collection system,

and construction of a new pumping station. This component of MWRA's CSO program provided reductions in CSO discharge from approximately 3.3 billion gallons (BG) annually in 1988 to approximately 1.0 BG in 2000 (MWRA 2000).

More recently, MWRA has begun work on the Braintree-Weymouth Relief Facilities Project. This project will expand and improve the Braintree-Weymouth System, which is MWRA's network of sewer pump stations, interceptors, and siphons that serves six Boston area communities. Wastewater generated by the six communities currently must pass through the Braintree-Weymouth pump station. The 54 MGD capacity at this pump station, however, is not sufficient to handle peak flows and presents a hydraulic bottleneck. The project will increase the Braintree-Weymouth System's peak flow capacity by approximately 19 MGD, streamlining the flow route from South Shore communities to the Nut Island Headworks and the Deer Island Treatment Plant. Specifically, the project includes constructing an intermediate pump station and a multi-use deep rock tunnel, replacing and rehabilitating the Braintree pump station, and adding new interceptors and siphons. The total project cost is estimated at \$150 million (MWRA 2001).

More information at <http://www.mwra.state.ma.us>

References

American Society of Civil Engineers (ASCE). 2000. *Protocols for Identifying Sanitary Sewer Overflows*. Prepared by Black & Veatch under EPA, Office of Wastewater Management Cooperative Agreement. EPA Cooperative Agreement #CX 826097-01-0. Reston, VA: ASCE.

EPA Office of Water. 1995. *Combined Sewer Overflows—Guidance for Nine Minimum Controls*. EPA 832-B-95-003.

Field, R., et al. 1994. *Optimization of CSO Storage and Treatment Systems*. Presented at “A Global Perspective for Reducing CSOs: Balancing Technologies, Costs, and Water Quality” Water Environment Federation (WEF) Specialty Conference, Louisville, Kentucky. July 10-13, 1994.

Massachusetts Water Resources Authority (MWRA). 2000. *MWRA Business Plan Strategy #17: Implement CSO Control Plan by FY09 - Draft*. v. 1.2. Retrieved September 1, 2003 <http://www.mwra.state.ma.us/org/busplan/17.pdf>

MWRA. 2001. *Facts about the Braintree-Weymouth Relief Facilities Project*. Boston, MA: Massachusetts Water Resources Authority. Retrieved September 4, 2003 <http://www.mwra.state.ma.us/03sewer/graphic/braintreeweyFS01.pdf>

NYSDEC. 2003. *Wet Weather Operating Practices for POTWs with Combined Sewers: “Technology Transfer Document.”* Retrieved September 1, 2003 http://www.dec.state.ny.us/website/dow/bwcp/ww_techtran.pdf

Philadelphia Water Department (PWD). 1997. *CSO Documentation Long Term Control Plan*. Submitted to: Pennsylvania Department of Environment Protection Bureau of Water Quality Management in partial fulfillment of NPDES Permit Nos. PA 0026689, 002662, 0026671 (January 27, 1997).

Sherrill, J.D., et al. 1997. *Rating and Optimization of Collection System Transport and Storage*. Presented at Water Environment Federation Technical and Exhibition Conference in Chicago, IL. October 18-22, 1997.

Inclusion of this technology description in this Report to Congress does not imply endorsement of this technology by EPA and does not suggest that this technology is appropriate in all situations. Use of this technology does not guarantee regulatory compliance. The technology description is solely informational in intent.

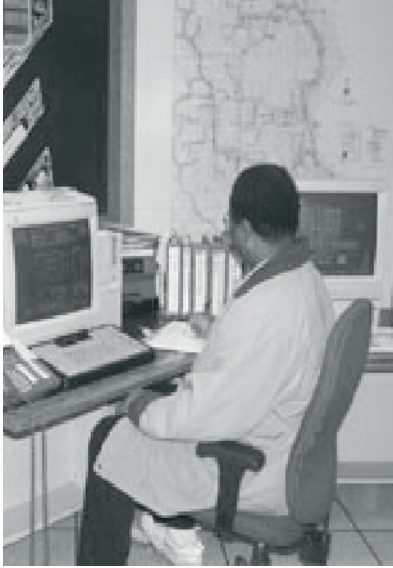

TECHNOLOGY DESCRIPTION

Collection System Controls

Monitoring & Real-Time Control

Overview

Effective monitoring programs enable evaluations of diurnal and day-to-day flow patterns as well as inflow and infiltration (I/I) in the system. Such programs also provide a basis to assess the need for, or effect of, maintenance efforts. Monitoring has the potential to provide insight into operational issues and problems, including the identification of CSO and SSO events, in a timely manner. Moreover, monitoring is valuable in establishing maintenance schedules, in developing hydraulic models for planning related to capital improvements, and for regulatory compliance.

In sanitary sewer systems (SSSs), enhanced monitoring information can be used operationally to identify blockages or capacity constrained areas of the system where wet weather SSOs may occur. The use of rainfall-derived infiltration and inflow (RDII) quantification methods can also serve as a predictive tool to control SSOs. In combined sewer systems (CSSs), the linkage of real-time flow, regulator, pump, and storage information can effectively maximize use of in-system and off-line storage facilities and maximize flow to the treatment plant. It should be noted that real-time control can also have substantial value in some SSSs (e.g., those sized for future growth or I/I). However, for practical as well as operational purposes, enhanced monitoring is discussed herein as an SSO control, and real-time control is discussed as a CSO control.

Enhanced Monitoring

Enhanced monitoring takes routine monitoring of system conditions a step further by using monitoring information to track patterns and guide operations and maintenance (O&M) decisions. Enhanced monitoring generally consists of a network of rain gages, flow meters, pump station, and storage measurement devices that are fully integrated into an information management system. The components of the information management system can include:

- Hardware to measure system conditions (i.e., rainfall, sewer flow, pumping rate, storage level, etc.);
- Software, a central processor, and work stations to house management programs and to track, analyze, and display system information;
- Reporting mechanisms for compliance purposes; and
- Established procedures to respond to problems as they are identified.

In practice, enhanced monitoring is typically applied systemwide as an SSO control. Abnormal wastewater flow patterns indicative of a blockage, pump station failure, or excessive I/I can be detected automatically. In sewer systems with enhanced monitoring programs (e.g., flow monitoring alarm systems), problematic conditions and blockages may be identified in advance so that prompt attention and repair may prevent SSOs from occurring. In cases where SSOs have already occurred due to blockage or power failure, early remote detection by an enhanced monitoring network can lead to a prompt response that minimizes the volume and duration of the overflow as well as any potential environmental and human health impacts. Enhanced monitoring can be an economical way to identify and track SSO events that were previously largely unpredictable.

RDII Quantification

During dry weather, flow in SSSs primarily consists of domestic, commercial, and industrial wastewater mixed with some groundwater infiltration. During periods of rainfall and snowmelt, however, dramatic increases in wastewater flows are often noted and can contribute to SSOs and increased treatment costs. The portion of sewer flow above normal dry weather flow is called RDII. Most communities served by SSSs are challenged to find effective means for predicting sewer system response to wet weather events; enhanced monitoring

programs often exceed their financial and staffing capabilities (WERF 1999).

RDII quantification methods are a tool for estimating the magnitude (frequency, location, and volume) of RDII and can inform efforts to improve sewer system performance. RDII quantification often precedes the development of enhanced monitoring programs

The Water Environment Research Federation (WERF) recently funded an extensive study that identified eight RDII hydrograph generation or RDII quantification categories (WERF 1999):

- Constant unit rate methods
- Percentage of rainfall volume (R-value) methods
- Percentage of streamflow methods
- Synthetic unit hydrograph methods
- Probabilistic methods (frequency analysis of peak RDII)
- Predictive equations based on rainfall/flow regression
- Predictive equations based on synthetic streamflow and basin characteristics
- RDII as a component of hydraulic software

These methods were tested under varying climatic and sewer operation conditions. With the goal of improved prediction and control of SSOs, the study found that no single RDII quantification method was universally applicable. Availability of data and experience of the research team were among the factors that influenced the usefulness of each method (WERF 1999).

A hydraulic (routing) analysis, which models the existing sewer system's ability to transport RDII, is recommended with RDII quantification to determine where SSOs will likely occur in the system. Once problems are characterized, RDII methods may also be used to evaluate and size appropriate control technologies and capacity relief scenarios. Because the same storms (including the same antecedent conditions and rainfall distributions) are unlikely to occur before and after controls are implemented, sewer system evaluations must rely on RDII quantifications (WERF 1999).

Real-Time Control

Real-time control seeks to optimize sewer system performance during wet weather events as flow and storage conditions change within the system. Many of the same information management system components described as part of enhanced monitoring are also required for real-time control. Real-time control is typically most applicable in CSSs, as these

systems tend to have substantial in-system storage in large pipes designed to transport excess wet weather flows. In addition to large pipes, CSSs may also have additional storage space (e.g., tunnels and tanks) that can be incorporated into a real-time control strategy. Maximizing system performance may lead to substantial savings in capital improvement programs if evaluated during the development of a long-term control plan (LTCP) (Field *et al.* 2000). Using feedback loops and rules to optimize storage, pumping, and treatment, real-time control technologies are capable of reducing the frequency, duration, and volume of CSOs through optimization of sewer system operations.

CSSs that use real-time control technology have system regulator elements such as weirs, gates, dams, valves, or pumps that can function in a real-time environment. Real-time control systems rely on monitoring data and use a customized software program to operate regulator elements without a significant time delay. Figure 1 shows a monitoring network used to operate a real-time control system.

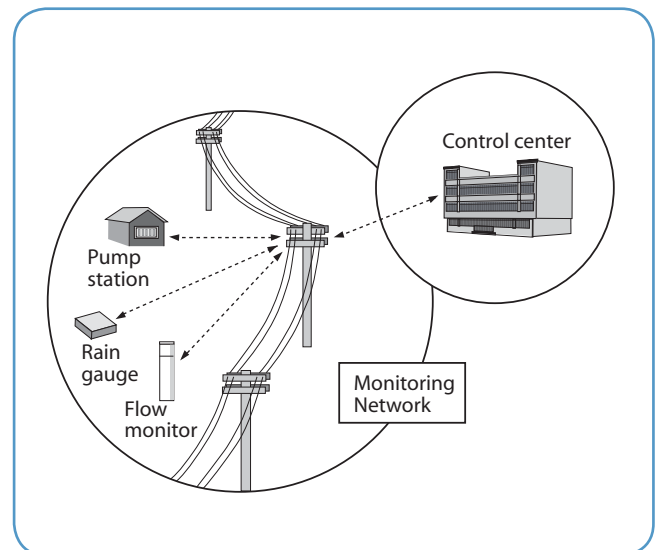

Figure 1. Schematic of a monitoring network.

The regulator elements function according to operating rules that are generally based on flow level, storage, or pumping rates monitored at points within the CSS. In a simple example, a regulator element can be controlled locally based on conditions that are monitored within the vicinity of that element. Alternatively, in a more complex example, global control of regulator elements would rely on a centralized control device that analyzes system-wide monitoring data. Centralized control systems can rely on either human operators or fully automated computer controls. Real-time control regulators that operate based on monitoring inputs are

referred to as reactive systems. Predictive systems, in contrast, include additional forecast data in the control process. Some predictive real-time control systems include a sewer system model as a component of the control device. In some instances, rainfall forecasts have been used successfully to optimize system operations in anticipation of rainfall.

Key Considerations

Applicability

The use of enhanced monitoring and real-time control is consistent with the goals and objectives of many O&M programs and EPA's 1994 CSO Control Policy. Enhanced monitoring and real-time control can be used to ensure that the public receives adequate notification of CSO and SSO events and potential impacts. Further, use of real-time control technologies for CSO control addresses two of the nine minimum controls (NMC). These are: maximizing use of the sewer system for storage; and maximizing flow to the wastewater treatment plant. In comparison, RDII quantification methods have lesser information requirements than enhanced monitoring techniques. RDII hydrograph generation methods can be used to predict RDII in different portions of an SSS and to evaluate source control scenarios, and in some cases, to develop enhanced monitoring programs.

Enhanced Monitoring

Sewer system monitoring is an essential component of an O&M program in most systems. An enhanced monitoring network utilizes fact-based knowledge to optimize sewer system performance. Enhanced monitoring can be used to determine the magnitude of the I/I and to better define locations where it is occurring. It can also provide direction for maintenance activities, detection of illicit storm water connections to the SSS, and in some cases, the detection of SSO events.

The size and complexity of the monitoring network usually depend on the size and complexity of the sewer system as well as financial considerations. In general, automated monitoring technologies are more applicable in larger systems, while simpler monitoring devices are better suited to smaller systems. In either case, the use of enhanced monitoring techniques can lead to better decisions on capital improvements required for wet weather control facilities.

Many municipalities have supervisory control and data acquisition (SCADA) systems already in place, which can be operated in an enhanced monitoring role if they are linked to broader information

technology management systems. The information collected by existing SCADA systems is often used locally rather than globally. Sharing relevant SCADA system information among many linked facilities as part of an information management system makes the information more meaningful; it also presents opportunities for detection of SSOs that would not otherwise exist.

RDII Quantification

Many communities do not have the resources necessary to implement enhanced monitoring programs. However, over-reliance on limited data and/or the rough interpretation of monitored flows can lead to oversimplification of RDII causes and implementation of inadequate control technologies. Selection of an appropriate technique for estimating RDII is critical. Usefulness of a given RDII quantification method depends on availability of data, experience of the analysis team, and purpose of the RDII evaluation (e.g., source control evaluation). Further, regardless of the RDII method selected, WERF (1999) found that testing on multiple storms is necessary to evaluate the true potential of the RDII quantification method for extrapolation or comparison with other wet weather events. Table 1 presents a number of factors that may confound the interpretation of monitoring data in SSSs.

Real-time Control

Real-time control, in general, works best for CSO communities with populations greater than 50,000. Local, rather than centralized, real-time control systems may be cost-effective for smaller CSO communities with limited control points. Real-time control tends to be more effective in areas with level, as opposed to steep, terrain where it is more practical to store wastewater in existing sewers. Further, a CSS that is already operating at or near capacity will not benefit from real-time control; systems which have capacity that is not being used effectively stand to gain more.

Real-time control has also proved useful for communities with both sanitary and combined sewers (e.g., Milwaukee, WI; Louisville, KY; and Quebec, Ontario, Canada). In such systems, real-time control is used to divert flows to and from storage systems during wet weather. For example, real-time control is used to prevent storage systems from filling entirely with combined sewage, reserving space for separate sewage. This is achieved by incorporating separate sewer volume predictions into the real-time operational strategies, where the goal is eliminating SSOs and minimizing CSOs (Schultz *et al.* 2001).

Table 1. Common interpretations of flow monitoring data (WERF 1999).

Monitoring Data Observation	Common Interpretation	Confounding Factors
Dry weather flow consistently higher than expected sanitary flow contribution	Infiltration through leaky pipes	<ul style="list-style-type: none"> Leakage from an adjacent lake or river directly into sanitary sewer Underground spring intercepted by the sanitary sewer Seasonal fluctuation in groundwater
Rapid, dramatic rise in flow coincides with rainfall initiation	Unauthorized direct connection of roof or yard drains	<ul style="list-style-type: none"> Leaking manhole lids or corbels in depressions that collect runoff Leaky pipes along stream banks Cross-connection with storm water systems Interconnection of the sanitary sewer with underground solution channels (common in karst topography)
Delayed and prolonged flow rise occurs after rain	Unauthorized connection of sump pumps or foundation drains to sanitary sewer	<ul style="list-style-type: none"> Granular backfill in the sanitary sewer trench acting as a french drain Seasonal fluctuation in groundwater; response may be rapid depending on soils and trenches
Flows rise proportionately to rainfall, but only up to an observable maximum	Direct connections with capacity restrictions	<ul style="list-style-type: none"> Further flow increases restricted by downstream blockages, backwater, or lift station capacity Further flow increases relieved by upstream overflows

Some advantages of real-time control include:

- Storage facilities can be dynamically operated and continuously optimized in response to changing conditions;
- Runoff and hydraulic models can be integrated into operating rules and control algorithms;
- System response can be predicted through use of rainfall forecast data and a local rain gage network with adequate spatial coverage; and
- Seasonal and spatial variation in rainfall and receiving water flows and volumes can be accounted for in the system.

Communities that do not experience much spatial or seasonal rainfall variation or that utilize receiving waters with a static assimilative capacity may not be able to take advantage of some these real-time control features.

Cost

The capital cost of implementing an enhanced monitoring or real-time control scheme depends on the quality and quantity of control, the measurement devices required for successful implementation, as well as any software needed to manage or process the data (Field *et al.* 2000). Monitoring and control schemes may not be sufficient as a stand-alone solution to completely control CSOs or SSOs; therefore, they should be evaluated as part of the solution. O&M costs are dependent on the characteristics of the system being monitored and include regular inspection of the monitors. In systems using real-time control, O&M costs also include mechanical maintenance of the regulator elements.

The initial costs of enhanced monitoring or real-time control can be significant and may be prohibitive for small communities. The monitoring costs, however, may be a fraction of the cost of large capital projects that would achieve similar levels of CSO and SSO reduction, such as construction of additional conveyance, storage, or treatment facilities.

Implementation Examples

SEATTLE, WA

Responsible Agency: Seattle Public Utilities

Population Served: 1.4 million

Service Area: 64 sq. mi.

Sewer System: 335 mi. sewer

Real-Time Sewer System Controls

Seattle was one of the first U.S. communities to implement and operate an advanced real-time control system. Seattle's system, called Computer Augmented Treatment and Disposal (CATAD), began operating in 1971. CATAD manages 13,120 acres of fully combined sewer area as well as 28,000 acres of partially-separated sewers. The network included 17 regulator structures and one major pumping station. CATAD has reduced CSO volume between 9 and

49 percent at different outfall locations. The actual reduction realized depends on the rainfall volume and patterns during each individual year.

The capital cost for CATAD was \$16.8 million, and O&M costs were approximately \$16 per acre (2002 dollars). Estimated costs for sewer separation or construction of additional storage capacity to achieve equivalent reductions in overflow volume range between \$127-\$760 million (2002 dollars). In the late 1980s, treatment plant computer hardware was upgraded, remote telemetry units at regulators and pump stations were replaced by programmable logic controllers, and operators' graphical displays were improved. Based on the success of the CATAD technology, Seattle implemented a new, predictive real-time control system that went online in early 1992. Rainfall prediction capabilities that utilized rain gage data and a runoff model were added at this time. A global optimization program was introduced that computed optimal flow and corresponding gate position for each regulator. Currently, the system's centralized computer hardware is being upgraded.

Contact: Bob Swarmer, King County Wastewater Treatment Division

MILWAUKEE, WI

Responsible Agency: Milwaukee Metropolitan Sewerage District

Population Served: 1.1 million

Service Area: 420 sq. mi.

Sewer System: 2,200 mi. of collector sewer;
310 mi. of intercepting and main sewer

Real-Time Sewer System Controls

In 1986, Milwaukee Metropolitan Sewerage District (MMSD) designed and installed real-time sewer system controls. The MMSD sewer system includes the Metropolitan Interceptor Sewer System (MIS) that collects flow from the local sewers; an Inline Storage System (ISS) that temporarily stores excess flows until treatment capacity is available, and a computer-based central control system. The MIS system collects wastewater from both sanitary and combined sewers and conveys flow to two wastewater treatment plants.

MMSD uses remote and local sensors to control intra-system flow diversions to both relief interceptors and temporary storage. Flows can be rerouted to avoid surcharging the system or to maximize treatment capacity during wet weather events. Routing is performed by adjusting diversion gates, which are controlled by monitoring multi-level sensors located at critical points in the MIS. Importantly, MMSD's real-time control system is used to prevent storage systems from filling entirely with combined sewage and to reserve space for the separate sanitary sewage. This is achieved by incorporating sanitary sewer volume predictions into the real-time operational strategies, where the goal is eliminating SSOs and minimizing CSOs. Precipitation and meteorological forecasts are used to calculate the storage volume that must be reserved for anticipated sanitary sewage flows.

MMSD's system was implemented to address chronic CSO and SSO problems cited in national and state court actions in the 1970s. In the mid-1970s, the city regularly experienced hundreds of SSOs and over 100 CSOs during wet weather; many homes in the sanitary sewer service area also faced sewage backups one or more times per year. MMSD has seen dramatic reductions in CSOs, SSOs, and backups in the last few decades. Furthermore, the real-time control system has provided much-needed flexibility in system operation, allowing MMSD to better accommodate variable precipitation patterns, growth patterns, and lake and groundwater levels (Schultz *et al.* 2001).

Contact: Nancy Schultz, CH2M Hill

QUEBEC, ONTARIO, CANADA

Responsible Agency: Quebec Urban Community

Population Served: 500,000

Service Area: 213 sq. mi.

Sewer System: Not Available

Real-Time Control System

In 1998-1999, the City of Quebec implemented a centralized, or global, optimal and predictive real-time control (GO RTC) system in its westerly sewer system. Quebec Urban Community's (QUC's) westerly catchment drains 82,000 acres and contains 41 miles of interceptor and 22 regulators; it is served by an 82 MGD treatment plant. The GO RTC equipment consists of five control stations, four

monitoring stations, thirteen rainfall stations, and one central control station (Colas *et al.* 2001). The GO RTC system improves the flow management of the westerly system by taking advantage of 3.7 million gallons of in-line storage as well as wet weather treatment capacity at the plant. Pressure flow conditions that occur in the system are also eliminated, thereby protecting downstream areas against basement backups. The cost of the western installation GO RTC system was approximately \$2 million. Operation costs are low because existing staff were trained to operate and maintain the system (Colas 2003).

In the late 1990s, EPA funded a demonstration study of three real-time control scenarios in the westerly QUC catchment (Field *et al.* 2000). Using modeling tools and rainfall data from the summer of 1998, Field *et al.* (2000) found that the automated central control system, eventually implemented as GO RTC, performed better as system complexity increased. Actual reductions in CSO volume have exceeded those predicted by Field *et al.* (2000)—i.e., reductions of 24-47 percent. Compared to simulations of past system configurations, CSO volumes were reduced by 60 percent in 1999, 75 percent in 2000, and 83 percent in 2001. At some sites, CSOs were eliminated. In other areas, where storage was limited, CSO frequency was reduced by more than 40 percent (Colas 2003).

Contact: H. Colas, BPR CSO

SAN DIEGO, CA

Responsible Agency: City of San Diego
Metropolitan Wastewater Department

Population Served: 1.3 million

Service Area: 310 sq. mi.

Sewer System: 2,300 mi. sewer

Flow Metering Alarm System

The City of San Diego MWWD installed a Flow Metering Alarm System (FMAS) in September 2000. FMAS uses flow meters to monitor wastewater flow conditions, which provides real-time event notification through the land-line telemetry system. Specifically, 92 alarmed flow meters provide coverage for 95 percent of MWWD's sewers with a diameter of 15 inches or greater. Flow meters are also used by MWWD to meter flows from San Diego and its 15 satellite agencies, collect data for sewer modeling, evaluate trunk

sewer capacities, and investigate I/I issues. MWWD hired a maintenance contractor to maintain all the flow meters in their system including those used for FMAS. In addition, MWWD created a new section of three to four staff (with supplemental help on nights and weekends) to monitor the sewer system, analyze data, and dispatch crews to investigate potential spills and/or minimize active SSOs.

The purpose of FMAS is to help prevent, detect, and minimize the impact of major SSOs in the MWWD system. An alarm signals when a FMAS meter experiences a 25 percent loss of flow. For some areas where the base flow is more consistent, the alarms can be set to activate when a 15 percent fluctuation in flow occurs. MWWD installed FMAS largely as a result of a large spill that occurred in February 2000 when the Alvarado Trunk Sewer was damaged during a winter storm, causing a 34 million gallon spill in an inaccessible canyon that went undetected for seven days. This spill forced beach closures, a highly undesirable situation for the City of San Diego and surrounding communities.

The FMAS has allowed MWWD to concentrate on specific areas of the SSS: trunk sewers where capacity is critical, remote areas, and sensitive areas including areas that would trigger beach closures. Although FMAS is principally used to detect major SSOs, it has also provided early warning of potential spills allowing crews to be dispatched in time to alleviate blockages. Over the past three years, MWWD has also considerably expanded its maintenance and cleaning program and is embarking on a 10-year capital improvement program to replace or rehabilitate structurally defective pipe, all in an effort to reduce future SSOs.

Contact: G. Hwang, City of San Diego Metropolitan Wastewater Division

ATLANTA, GA

Responsible Agency: Atlanta Department of Public Works

Population Served: 1.2 million

Service Area: 131.4 sq. mi.

Sewer System: 2,000 mi. of sanitary and combinedsewer

Automated Monitoring System

In 2002, Atlanta installed a web-based information system that automates data collection from flow meters and rain gages. One hundred twenty flow meters and 35 rain gages provide coverage of the city's entire sewer system and supply data to the information system. This system enables city staff to view pipe capacities, flow levels, and float positions (in the pumping stations) via the Internet. Alarms calibrated to the system activate when flow velocities or depths reach predefined critical levels, where the potential for SSO events is high.

Flow meters and rain gages have been used in the Atlanta sewer system for a number of years. In the past, field crews were required to collect the data, and it often took many weeks for the data to be analyzed. Without alarms or real-time data, the city was frequently faced with responding to spills after they had been reported by the public or detected by field crews. By automating data collection, the city is better able to analyze the data in a timely manner. Crews may be sent to investigate potential problems and act to prevent SSOs rather than respond to an overflow event.

In addition, the system has helped the city better allocate its resources and focus on sewer lines that need repair, areas where flow capacity is frequently exceeded, and sections where recurrent blockages occur. If grease build-up is identified as a chronic problem in a certain section of pipe, the crew that handles oil and grease issues will be dispatched to investigate (e.g., check grease traps). The city reports that businesses, such as restaurants, are more receptive to preventative operation and maintenance changes when shown evidence (provided by the monitoring data and CCTV) of the recurrent problem.

Contact: K. Toomer, Atlanta Department of Public Works

References

Colas, H., *et al.* 2001. *Operation and Performance of an Optimized Real time Control System for Wet Weather Pollution Control, Vulnerability of Water Quality in Intensively Developing Watersheds, Making the Case for High-Performance Integrated Control.* Presented at the University of Georgia, Athens, Georgia, May 14-16, 2001.

Colas, H. BPR CSO. E-mail correspondence with Limno-Tech, Inc., 2003. Washington, DC.

Field, R., Villeneuve, E., Stinson, M.K. 2000. "Get Real!" *Water Environment & Technology.* Vol. 12, No. 4: 64-67.

Hwang, G., City of San Diego Metropolitan Wastewater Division (MWW). Interview by Limno-Tech, Inc., February 2003. Washington, DC.

Schultz, N., *et al.* 2001. Milwaukee's Experience in Collection System Controls. Proceedings of WEF Speciality Conference, A Collection System Odyssey, Bellevue, Washington, July 2001.

Schultz, Nancy, CH2M Hill. E-mail correspondence with Limno-Tech, Inc., 2003. Washington, DC.

Stevens, Pat, ADS Environmental Services. Interview by Limno-Tech, Inc., January 2003. Washington, DC.

Swarmer, Bob, King County, WA Wastewater Treatment Division. Interview by Limno-Tech, Inc., December 2002. Washington, DC.

Toomer, K., Atlanta Department of Public Works. Interview by Limno-Tech, Inc., February 2003. Washington, DC.

Water Environment Research Foundation. 1999. *Using Flow Prediction Technologies to Control Sanitary Sewer Overflows.* Prepared by D. Bennett, *et al.* Project 97-CTS-8. Alexandria, VA: Water Environment Research Foundation.

Inclusion of this technology description in this Report to Congress does not imply endorsement of this technology by EPA and does not suggest that this technology is appropriate in all situations. Use of this technology does not guarantee regulatory compliance. The technology description is solely informational in intent.



TECHNOLOGY DESCRIPTION

Collection System Controls

Inflow Reduction

Overview

Inflow is the direct introduction of storm water into a sewer system; common sources include roof leaders, basement sump pumps, area drains in yards and driveways, foundation drains, cracked or broken manhole covers, and cross connections with a separate storm water system. Inflow occurs by design, through disrepair, and via illicit connections. Inflow reduction refers to techniques used to reduce the amount of storm water that enters a combined sewer system (CSS) or a sanitary sewer system (SSS).

This technology description focuses on inflow associated with direct connections of storm water sources to the sewer system. Much of the inflow to CSSs is intentional as these systems were designed to convey excess storm water away from dwellings and to reduce localized flooding. Inflow to SSSs is generally not by design and is often illicit. By reducing the volume of storm water entering a sewer system, inflow controls free conveyance capacity and available storage. This, in turn, aids in reducing the frequency, volume, and duration of wet weather CSO and SSO events. Inflow reduction is particularly applicable in areas where open land is available to receive redirected storm water for infiltration or detention, or where storm water can be diverted to surface waters either directly or via a separate storm water system.

Specific inflow reduction techniques that will be discussed in this technology description include disconnection of roof leaders; redirection of area drains, foundation drains, and basement sump pumps; and cross connection elimination.

Disconnection of Roof Leaders

Roof leaders or down-spouts convey rain that falls on residential and commercial roofs directly to the sewer system. The use of this practice in CSSs is usually intentional, and in some instances, required by local ordinance. Use of roof leaders to convey rainwater to an SSS is generally considered to be an illicit connection

in most, but not all, communities. In SSS areas, roof leaders may have been connected to the SSS by builders or homeowners to alleviate localized flooding associated with wet weather events. The disconnection of roof leaders from the sewer system and redirection to lawns, dry wells, or drain fields, where flows can infiltrate into the soil, reduces the amount of storm water entering the sewer system. Disconnection of roof leaders works best in residential areas where open land is available. City-wide surveys are often necessary to determine the extent of roof leader connections to the sewer system. This inflow reduction technique can be introduced as a voluntary effort or as a mandatory requirement. Guidance can be offered to individual homeowners on how to redirect the inflow from roof leaders, and it can be combined with other inflow reduction techniques such as area drain and basement sump pump redirection. Some communities have offered financial incentives to homeowners to disconnect roof leaders and have prequalified local contractors to provide this service.

Redirection of Area and Foundation Drains and Basement Sump Pumps

Many buildings have a system of area and foundation drains and basement sump pumps to alleviate drainage problems. As with roof leaders, area and foundation drains and basement sumps are typically connected to CSSs by design. In some parts of the country, both area drains and foundation drains are connected to the SSS by design, but in most instances they are considered to be illicit connections to the SSS. Flows from area and foundation drains and basement sumps can generally be redirected away from the sewer system to lawns, dry wells, drain fields, or an existing separate storm water system. However, redirection may require additional pumping. City-wide surveys often need to be conducted to determine where area drains and sump pumps are located, whether they discharge directly to the sewer system, and whether it is feasible to redirect them.

Elimination of Cross Connections

Cross connections are direct connections between an SSS and a separate storm water system. By definition, it is not possible to have a cross connection in a CSS. Cross connections most commonly occur where the sanitary service lateral from a home or commercial establishment is inappropriately connected to the storm water system. Cross connections also often exist as remnants of incomplete sewer separation projects. Detection and elimination of cross connections between separate sanitary and storm water systems can reduce inflow during wet weather events and reduce the concentration of bacteria, nutrients, and oxygen demanding substances contained in storm water discharges.

Key Considerations

Applicability

There are a number of different sewer testing and inspection approaches that are useful for locating sources of inflow. These include visual inspections, smoke testing, dye-water flooding, water sampling from manholes, interpretation of public complaints, and video inspection. The most appropriate technique will depend on suspected inflow sources and site-specific conditions. Additional information on techniques for locating sources of inflow is provided in the “Testing and Inspection Technology Description” in Appendix B of the *Report to Congress on the Impacts and Control of CSOs and SSOs*.

Inflow reduction can be an efficient way to reduce the volume of storm water delivered to both CSSs and SSSs, and can result in improved sewer system performance. Provided below are specific considerations for each of the inflow reduction techniques described above.

Disconnection of Roof Leaders

Disconnection of roof leaders is a relatively simple and low-cost technique for reducing inflow. It is more feasible in residential areas where houses are detached, yards are sufficiently large to accommodate increased overland flow and soils have relatively high infiltration rates. In order for a roof leader disconnection program to be successful the public must be educated about the benefits of disconnection and methods for implementing the program. This can be time-consuming and will most likely require some type of rebate program or other incentive for compliance. Communities who have experimented with voluntary disconnection programs found that approximately 20 percent of property owners are willing to participate (NBC 2000). In addition, because the effect per

individual roof leader is small, this program must be implemented with broad participation across entire neighborhoods in order for there to be a discernible reduction in sewer system flow.

Redirection of Area and Foundation Drains and Basement Sump Pumps

In general, area and foundation drains and sump pumps are a less common source of inflow than roof leaders, and their location may be harder to determine. The feasibility of redirecting drains and sump pumps depends on soil type, land slope, and the drainage conditions around the home or building. If a separate storm water system does not exist, then the excess rainwater must be conveyed to a distance far enough away and at a reverse slope from the building so that water is not allowed to migrate back into the building. Similar to the redirection of roof leaders, the volume controlled per individual drain or sump pump is small. Consequently, the program must be implemented with broad participation across neighborhoods in order for there to be a discernible reduction in sewer system flow. Implementation of this type of redirection program can be time-consuming and may necessitate use of a rebate program or other incentives for compliance.

Elimination of Cross Connections

Several methods exist for detecting and eliminating cross connections. Common sewer testing and inspection approaches are often appropriate for identifying storm water sources that were inappropriately connected to the SSS. In addition, there are a number of useful indicators for detecting connections between private building service laterals and the separate storm water system. These include inspections to determine the presence of unexpected dry weather flow in storm sewer lines, and finding biological indicators that denote the presence of human fecal matter in storm drain outfalls. Once cross connections are detected, excavation and correction are necessary. In addition to detection and elimination of existing cross connections, plans for new development should be carefully reviewed and inspections should be conducted during construction in order to prevent future cross connections from being placed.

Cost

The actual cost associated with implementation of an inflow reduction program varies considerably and is dependent on site-specific conditions. Disconnection of roof leaders and redirection of basement sump pumps can be quite economical under some circumstances. Disconnecting area and foundation drains typically requires

excavation around homes, and is therefore more expensive and disruptive than other inflow controls. Key parameters in determining the effectiveness of inflow reduction techniques are the infiltration rate of the soil in the area where flows will be redirected and the land area available to infiltrate the wet weather flow. Typical cost ranges for various techniques discussed in this technology description are presented in Table 1.

Table 1. Costs of inflow reduction activities

Technology	Cost
Disconnection of roof leaders	\$45-\$75 for individual homeowners
Redirection of area and foundation drains and basement sump pumps	Varies based on site-specific requirements. Sump pump redirection costs \$300-\$500 per home ^a
Cross connection elimination	Varies depending on location. Typical point repairs costs \$600-\$8,500 ^b

^a EPA 1999

^b Arbour and Kerri 1998

Implementation Examples

JOHNSON COUNTY, KS

Responsible Agency: Johnson County Wastewater (JCW)

Population Served: 500,000

Service Area: 20 sq. mi.

Sewer System: 1,700 mi. of sanitary sewer

Inflow Reduction Program

Wet weather SSOs were a frequent occurrence in Johnson County in the early 1980s. A comprehensive system-wide evaluation was conducted in 1983, which included smoke and dye-water testing of sewer lines, flow and rainfall monitoring, visual pipe inspections, and closed circuit television

inspections. The survey identified inflow as a major contributor to wet weather SSOs. JCW's response was to launch an inflow reduction and sewer system rehabilitation program. An ordinance was passed by the Johnson County Board of Commissioners that made it illegal for residents to make connections from surface or groundwater sources to the SSS. This ordinance provided JCW with the legal authority to require removal of unpermitted inflow sources, and to prohibit construction of new ones.

As part of the disconnection program, JCW initiated private property inspections to identify inflow sources and advise property owners on removal actions. Inspectors toured commercial and residential building interiors and grounds, and they gathered data on the location of foundation and area drains, roof leaders, and other apparent connections to the SSS. Sources suspected of contributing to storm water inflow were subjected to smoke and/or dye-water testing, and all unpermitted sources were scheduled for disconnection. As shown on the right, the most common sources of inflow were foundation drains, area drains, sump pumps, and roof leaders. JCW established informal fixed-price contracts with local contractors to complete the work. To help JCW prioritize its remedial efforts, a hydraulic model was developed with the data from the survey. The inflow reduction program was completed in 1994. The inflow reduction and sewer rehabilitation program resulted in significant reductions in capacity-related SSOs; wet weather flow rates in the sewer system were reduced by an average of 280 MGD during the 10-year, 6-hour storm. The total cost of the program was \$48.8 million, which includes \$11.2 million for the reduction of inflow from private property.

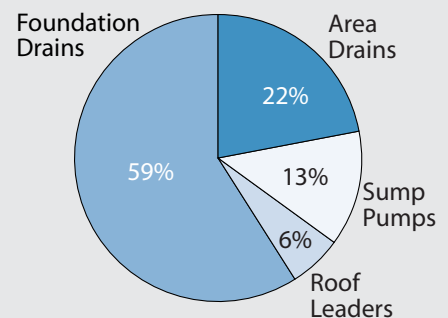

Types and distribution of inflow

More information at http://cfpub2.epa.gov/clearinghouse/preview.cfm?RESOURCE_ID=253743

ROCKFORD, IL

Responsible Agency: The Rock River Water Reclamation District

Population Served: 250,000

Service Area: 80 sq. mi.

Sewer System: 1,100 mi. of sanitary sewer

Sewer System Evaluation Survey

The Rock River Water Reclamation District in Rockford conducted a survey of a portion of its service area that was experiencing SSOs during periods of heavy rainfall. The purpose of the survey was to determine the extent of inflow and to recommend a plan for mitigation that included a

cost-effectiveness analysis to justify the recommended work. Inflow sources were identified by smoke testing all sanitary sewers (approximately 77,000 linear feet) by dye-water testing storm systems adjacent to sanitary sewers, and with voluntary inspections of approximately 1,300 buildings for sources on private property. Infiltration and inflow (I/I) data were collected and analyzed in terms of location, pipe condition, flow rate, potential rehabilitation method, and cost. The relative cost-effectiveness calculations, using ratios of rehabilitation costs versus treatment-transport costs, provided the basis for rehabilitation recommendations. The primary sources of inflow identified were roof leaders, foundation drains, and sump pumps. This investigation identified 68 inflow sources that contributed an estimated 421 gallons per minute, based on a 5-year storm event (1.7 inches per hour). The investigation also determined that 75 percent of the I/I originated on private property.

Number of identified inflow sources.^a

Area	Number of Defective Sites	Inflow (Gallons Per Minute)
Cherry Valley	7	38.0
Dawson Avenue	26	167.6
Pepper Drive	35	147.8

^aWEF 1999

More information at <http://www.rwrwd.dst.il.us/>

SOUTH PORTLAND, ME

Responsible Agency: City of South Portland

Population Served: 23,200

Service Area: 12 sq. mi.

Sewer System: 16.6 mi. of combined sewer

Rebate Program to Reduce Inflow

The City of South Portland invested almost \$2.5 million between 1986 and 1995 to reduce wet weather inflow into their CSS. The program involved surveying 6,000 residential buildings. The survey identified approximately 380 roof leaders and 300 sump pumps that were connected to the CSS. Property owners were notified and offered the

following incentives to disconnect the inflow sources: \$75 for roof leader redirection and \$400 for sump pump redirection. At the program's completion in 1995, 64.5 percent of all known sources had been redirected. The program resulted in a reduction in CSO volume of 58 MG per year, a three percent reduction in annual flow to the local wastewater treatment plant, and fewer reported residential backups. The total cost of the rebate program was \$128,000. The inflow reduction program eliminated more than 420 gallons per year of storm water from the CSS for every dollar spent.

Contact: Dave Pineo, Engineering Department, City of South Portland

References

Arbour, Rick, and Ken Kerri. 1998. *Collection Systems: Methods for Evaluating and Improving Performance*. Prepared for EPA, Office of Water Programs, Municipal Permits and Operations Division and developed under EPA Grant No. CX924908-01-0. Sacramento, CA: California State University, Sacramento Foundation.

EPA Office of Water. September 1999. *Combined Sewer Overflow Technology Fact Sheet: Inflow Reduction*. EPA-F-99-035.

Narragansett Bay Commission (NBC). April 2000. *Stormwater Attenuation Study - Technical Memorandum No. 3, Evaluation of Alternatives*. Prepared by the Maguire Group Inc. Rhode Island: NBC.

Water Environment Federation (WEF). 1999. *Control of Infiltration and Inflow in Private Building Connections*. Alexandria, VA: WEF.

Inclusion of this technology description in this Report to Congress does not imply endorsement of this technology by EPA and does not suggest that this technology is appropriate in all situations. Use of this technology does not guarantee regulatory compliance. The technology description is solely informational in intent.



TECHNOLOGY DESCRIPTION

Collection System Controls

Sewer Separation

Overview

Sewer separation is the practice of separating the single pipe system of a combined sewer system (CSS) into separate systems for sanitary and storm water flows. Sewer separation, like other types of CSO control, is intended to reduce CSO volume, the number of CSO outfalls, or both. In practice, there are three distinct approaches to sewer separation:

- Full separation wherein new sanitary sewer lines are constructed with the existing CSS becoming a storm sewer system. This is probably the most widely used form of separation.
- Full separation wherein an entirely new storm sewer system is constructed with the existing CSS remaining as a sanitary sewer system. This form of separation is not often used because the capacity of the existing CSS was designed to accommodate storm runoff, which is more than what is required to accommodate sanitary flows.
- Partial separation wherein a new storm sewer system is constructed for street drainage, but roof leaders and basement sump pumps remain connected to the existing CSS allowing flow to enter the CSS during wet weather periods.

Full separation can be applied on a system-wide basis to eliminate the CSS. This approach is often practical only for communities with small areas served by combined sewers. Partial separation of select areas within the CSS is widely used in large and small CSO communities. In fact, a survey of readily available information in NPDES files indicates that sewer separation is the most widely used CSO control (EPA 2001). This suggests that most CSO communities opportunistically find portions of their CSS where separation is a cost-effective CSO control. Under these circumstances, separation is often implemented in conjunction with other public works projects, including road work and redevelopment.

Key Considerations

Sewer separation can be highly effective in controlling the discharge of untreated sewage to water bodies. Under ideal circumstances, full separation can eliminate CSO discharges. However, sewer separation on its own does not always lead to an overall reduction in pollutant loads or the attainment of water quality standards. Discharges of urban runoff from the newly separate storm sewer system often contain substantial pollutant loads that contribute to water quality problems. A comparison of average pollutant concentrations from a variety of sources is presented in Table 1. As shown, the pollutant concentrations in urban runoff can be quite high. From a management standpoint, the implementation of storm water controls is usually required following sewer separation in order to achieve the necessary pollutant load reductions for attainment of water quality standards.

Table 1. Typical pollutant concentrations.

Contaminant Source	BOD ₅ (mg/L)	TSS (mg/L)	Fecal Coliform (#/100mL)
Untreated wastewater	88 - 451 ^a	118 - 487 ^a	1,000,000 - 1,000,000,000 ^b
CSO ^c	4 - 699	4 - 4,420	1,100 - 1,645,000
Urban runoff ^d	0.41 - 370	0.5 - 4,800	1 - 5,230,000
Treated wastewater ^e (disinfected)	12 - 140	0.5 - 35	<200

^a AMSA 2003

^b NRC 1996

^c Chapter 4 of EPA's 2003 *Report to Congress on the Impacts and Control of CSOs and SSOs*

^d Pitt *et al.* 2003

^e EPA 2000

From a regulatory standpoint, implementation of sewer separation satisfies the requirements of the CSO Control Policy. However, the newly-created sanitary and storm water systems become subject to existing NPDES requirements for storm water and separate sanitary sewer systems.

Some CSO communities find that more cost-effective overall reductions in pollutant loads can be achieved with the implementation of other CSO controls such as storage and treatment, instead of sewer separation. Having the storm water collected and conveyed in a CSS does present some environmental advantages if most of the wet weather flow is given the minimum treatment required by the CSO Control Policy (i.e., the equivalent of primary treatment and disinfection, if necessary).

From both cost and design standpoints, it is often difficult to fully separate CSSs. The occurrence of occasional residual overflows is common in many CSSs that have been separated. The cost of full separation can be prohibitive, and some communities opt for partial separation for this reason. Several states require sewer separation to the extent necessary to eliminate CSOs under specific design storm conditions (i.e., the 2-year, 24-hour storm). This leaves a legacy of infrequent but substantial CSOs during large wet weather events or periods of snow melt. The difficulty in achieving full separation can leave a community with residual overflows that may be subject to potentially more stringent requirements for SSOs.

Applicability

A major benefit of sewer separation is that it has the potential to completely eliminate the CSOs and the unwanted discharge of raw sewage to receiving waters from an antiquated sewer system. Consequently, public health, water quality, ecological, and aesthetic benefits can be achieved through sewer separation. Another advantage of sewer separation is the reduction of wet weather flows to the wastewater treatment plant. Sewer separation diverts storm water to a separate storm water system during rainfall periods. The diversion of storm water reduces system-wide stress and frees up sewer system conveyance and wastewater treatment capacity. Sewer separation also offers a solution to localized flooding and basement backup problems caused by excess water entering the sewer system. Public health and aesthetic benefits accrue where public exposure to raw sewage in homes, businesses, and other public areas is reduced.

Cost

Sewer separation is expensive relative to other CSO controls, and full sewer separation is typically the most expensive CSO control alternative evaluated in most communities. Example unit costs for sewer separation are presented in Tables 2 and 3.

Table 2. Sewer separation costs per linear foot of CSS.

CSO Community	Cost per Linear Foot ^a
Detroit, MI: Rouge River Project ^b	\$175 - \$220
Syracuse, NY: Onondaga Lake Improvement Project ^c	\$490 for residential areas (estimate) \$610 for commercial areas

^aCosts are in 2002 dollars

^bIncludes removing existing pavement, laying a new sewer line, re-paving, and re-sodding

^cIncludes a 25 percent contingency for mobilization, bonds, permits, survey, stakeout, and drawings; does not include internal building plumbing modifications

Table 3. Sewer separation costs per acre of service area.

CSO Community	CSS Area (Acres)	Reported Costs ^a (Million)	Cost Per Acre
Seaford, DE	1,260	\$2.2	\$1,750
Skokie/ Wilmette, IL	6,784	\$213 ²	\$31,397
St. Paul, MN and surrounding areas	21,117	\$374	\$17,730
Portland, OR	N/A ^b	N/A	\$19,000
Providence, RI	180	\$14.6 ^c	\$81,000

^a Costs are in 2002 dollars

^b Not available

^c Estimated costs; community found other CSO controls to be more cost effective (NBC 2000)

Sewer separation can also be very disruptive. Disturbances caused by construction activities required to implement sewer separation are widespread and relatively long-lasting; and include digging up roads, altering traffic patterns, and potentially disrupting other utility services.

Implementation Examples

RANDOLPH, VT

Responsible Agency: Town of Randolph
Population Served: 2,270

Sewer Separation

Randolph, a town of approximately 2,270, is located on the White River in central Vermont. In 1990, the State of Vermont developed a CSO Control Policy that encouraged sewer separation. Compliance requires elimination of CSO discharges during any storm with precipitation less than 2.5 inches of rain over a 24-hour period. Randolph completed a sewer separation program during the mid-1990s that consisted of construction of a new separate storm water system throughout much of the downtown commercial district and adjacent residential areas. A total of 44 storm water catch basins were separated from the CSS, which was approximately 85 percent of the catch basins that were known or suspected to be connected.

Since completion of the main CSO abatement program in 1996, Randolph has continued to implement additional CSO control through separation of smaller combined sewer areas as part of road improvements under its capital improvement plan. This has resulted in the separation of six additional catch basins. Currently, the town has separated 95 percent of its combined sewers. Post-sewer separation monitoring has shown an 80 percent reduction in the duration of CSO events recorded at the CSO outfall located at the wastewater treatment facility. This reduction is based upon data collected from a 20-month period from 1998-2000 compared with data collected prior to CSO control. As of 1997, approximately \$2.66 million had been spent on the town's CSO abatement program.

Though significantly reduced, CSOs still occur, and Randolph plans to further its CSO abatement efforts through a plan that spans six years (2001-2006) at a projected cost of \$500,000. Planned projects include sewer line replacement and upgrades as well as continued sewer separation.

Contact: Joe Voci, Town of Randolph

SEAFORD, DE

Responsible Agency: City of Seaford
Population Served: 6,699
Service Area: Not Available
Sewer System: 22.7 mi. of sewer

City-wide Sewer Separation

The City of Seaford, a community of 5,900, is located in southwestern Delaware. In 2002, Seaford completed a major sewer separation program covering approximately 1.97 square miles. The goal of this program was to eliminate untreated CSO discharges into the Nanticoke River, a tributary of the Chesapeake Bay, during periods of wet weather. Compliance with Delaware and EPA regulations and water quality initiatives provided the driving force for this program. In addition, the program was designed to benefit city residents and recreational users of the Nanticoke River. Prior to sewer separation, Seaford's wastewater treatment plant was unable to process all the combined sewage captured by the CSS during wet weather events. This led to frequent discharges at four CSO outfalls located in downtown residential and commercial areas.

The initial plan to separate the combined sewers of Seaford was developed in 1984 with the objective of complete separation. Implementation of the entire program was scheduled in eight phases and took 18 years to complete, due to construction and financial constraints. The entire combined sewer area has been separated (approximately 40 percent of the city). Efforts to control the resulting storm water discharges to the Nanticoke River are currently underway. The cost of the sewer separation program was \$2.2 million.

Contact: Charles Anderson, City of Seaford

ST. PAUL, SOUTH ST. PAUL, AND MINNEAPOLIS, MN

Responsible Agency: Metropolitan Council Environmental Services Division (MCES) and the cities of St. Paul, South St. Paul, and Minneapolis

Population Served: 2.5 million

Service Area: 3,000 sq. mi.

Sewer System: 600 mi. of sewer

Full Sewer Separation

Working cooperatively under the Metropolitan Council's Environmental Services Division (MCES), the cities of St. Paul, South St. Paul, and Minneapolis completed a 10-year, \$331 million dollar sewer separation program in 1996 (MCES 1996). The goal of this program was to reduce the pollutant load delivered to the Mississippi River from CSO

discharges. Prior to sewer separation, the average volume of untreated CSO discharges from the metro areas was estimated at 4.6 BG per year, with discharges occurring on average once every three days. Separation of St. Paul, South St. Paul, and Minneapolis combined sewers began in 1985 as part of an on-going capital improvement program, with construction initially scheduled to be complete in 2025. Due to public demand, the Minnesota Legislature adopted an accelerated program aimed at completing the sewer separation by 1995. Implementation of the program resulted in the installation of 189 miles of separate storm sewers and 11.9 miles of new sanitary sewers. This amounted to separation of approximately 33 square miles of combined sewer areas: 6.66 square miles in Minneapolis, 24.53 square miles in St. Paul, and 1.8 square miles in South St. Paul. The disconnection of roof leaders was also an important component of the program as it was estimated that they contributed 20 percent of the CSO volume in St. Paul.

By design, the sewer separation program provided the opportunity to implement other municipal infrastructure improvements during construction. These included:

- Repair of existing sewers
- Disconnection of 21,900 residential rain leaders from the CSS
- Replacement of 3,500 lead water services with copper pipes
- Upgrade of other local utilities
- Installation of 8,200 new street lights
- Installation of handicapped-accessible ramps

As a result of sewer separation, water quality in the Mississippi River and other local waterbodies has improved. MCES noted lower fecal coliform bacteria levels in the river, the return of the pollution-sensitive Hexagenia Mayfly, and increases in fish populations. Sewer separation is believed to be the major reason for the decrease in fecal coliform levels from an average of 500 MPN/100 mL in 1976 to an average of 150 MPN/100 mL in 1995 in the waters below Minneapolis. The program also benefitted local waterfront development along the Mississippi River.

Contact Tim O'Donnell, Metropolitan Council

References

Association of Metropolitan Sewerage Agencies (AMSA). 2003. *The AMSA 2002 Financial Survey: A National Survey of Municipal Wastewater Management Financing and Trends*. Washington, DC.

EPA. 2001. *Report to Congress: Implementation and Enforcement of the Combined Sewer Overflow Control Policy*. EPA/833-R-01-003.

EPA Office of Water. 2000. *Progress in Water Quality: An Evaluation of the National Investment in Municipal Wastewater Treatment*. EPA-832-R-00-008.

Metropolitan Council Environmental Services (MCES). 1996. *Separating Combined Sewers to Improve and Protect Mississippi River Water Quality: A Ten-Year Commitment, Annual Progress Report to the Public - Year Ten*. St. Paul, MN: MCES and Cities of Minneapolis, St. Paul, South St. Paul.

The Narragansett Bay Commission (NBC). 2000. *Storm Water Attenuation Study: Technical Memorandum No.3 Evaluation Alternatives*. Prepared by MacGuire Group, Inc. Rhode Island: NBC.

National Research Council (NRC), Committee on the Use of Treated Municipal Wastewater Effluents and Sludge in the Production of Crops for Human Consumption. 1996. *Use of Reclaimed Water and Sludge in Food Crop Production*. The National Academies Press.

Pitt, R. *et al.* 2003. "The National Stormwater Quality Database (NSQD, version 1.0)." Retrieved August 6, 2003. Tuscaloosa, AL: University of Alabama. <http://www.eng.ua.edu/~rpitt/Research/ms4/Paper/Mainms4paper.html>

Inclusion of this technology description in this Report to Congress does not imply endorsement of this technology by EPA and does not suggest that this technology is appropriate in all situations. Use of this technology does not guarantee regulatory compliance. The technology description is solely informational in intent.



TECHNOLOGY DESCRIPTION

Collection System Controls

Sewer Rehabilitation

Overview

The structural integrity of many sewer system components has deteriorated from use and age. This gradual breakdown allows greater amounts of groundwater and storm water to infiltrate into the sewer system, which increases the hydraulic load, and in turn, reduces the system's ability to convey all flows to the treatment plant. During wet weather events, excessive infiltration can cause or contribute to CSOs and SSOs. There are many reasons why a system may deteriorate to the point where infiltration becomes a problem. These include (WEF 1999):

- Inadequate design and construction practices
- Inadequate or improper bedding material
- Root intrusion
- Pipe breakdown from chemical corrosion
- Traffic loadings
- Soil movement and settling
- Groundwater fluctuations
- Cracking and aging
- Inadequate installation and maintenance

Sewer rehabilitation helps restore and maintain the structural integrity of a sewer system, in part by reducing or mitigating the effects of infiltration. Specific sewer rehabilitation techniques discussed in this description include:

- Removing and replacing defective lines
- Shotcrete
- Trenchless methods

The presence of debris will limit the effectiveness of sewer rehabilitation efforts; therefore, before initiating sewer rehabilitation, it is essential to remove any debris or roots that may be present in the sewer line. When rehabilitating a sewer line, it is also important to consider rehabilitation of system components, such as manholes and service laterals, since these may also be subject to infiltration. More information on sewer cleaning and manhole and service

lateral rehabilitation is presented in additional technology descriptions included in Appendix B of *Report to Congress on the Impacts and Control of Combined Sewer Overflows and Sanitary Sewer Overflows*.

Removing and Replacing Defective Lines

In many cases, it is not practical or desirable to rehabilitate existing sewers. Removing and replacing part or all of a defective sewer is the most common and proven method for eliminating inflow and infiltration (I/I), as well as correcting other structural problems. Often called “dig-and-replace,” the original pipe is excavated and disconnected from the sewer system. The pipe is then removed and replaced with a new, often larger, pipe. Alternatively, a new pipe may also be positioned parallel to the existing sewer and connected to the sewer system.

Shotcrete

Shotcrete is a mix of cement, sand, and water that is applied to the walls of the sewer using air pressure. Shotcrete generally consists of 30 percent cement and 70 percent sand (Shotcrete 2001). A welded wire mesh screen is often constructed over the section to be rehabilitated to provide additional support for the shotcrete mixture. The screen is covered by at least one inch of shotcrete to create a smooth surface. To apply shotcrete, the sand and cement mixture is forced through a hose to a mixing chamber that contains water. The mixture is then “shot” into place using air pressure. Major structural problems can often be remedied using shotcrete (CSU 2001).

Trenchless Technologies

Trenchless sewer rehabilitation technologies use the existing sewer to support a new pipe or a liner. As the name implies, trenchless technology requires less surface interruption than to dig-and-replace a defective sewer line. Trenchless technologies include sliplining, cured-in-place pipe (CIPP), modified cross-section liners, and pipe bursting.

Sliplining

Sliplining involves placing a new, smaller diameter liner in the existing sewer. The new liner is then grouted to the existing pipe to improve structural integrity and prevent leaks (EPA 1999). The sliplining process can be continuous, segmented, or spiral wound. During continuous installation, the total length of lining is inserted at strategic locations. Segmented installation requires the pipe liner to be broken into portions and then assembled at access points in the sewer system. As shown in Figure 1, spiral wound lining is interlocked forming a spiral that is inserted into the pipe from a manhole or other access point. Sliplining may require access to the sewer line beyond that which a manhole can provide; an insertion pit may need to be created. Therefore, sliplining is not always a completely trenchless technology, but it is much less intrusive than traditional dig-and-replace methods (EPA 1999). Also, sliplining is not applicable in force mains.

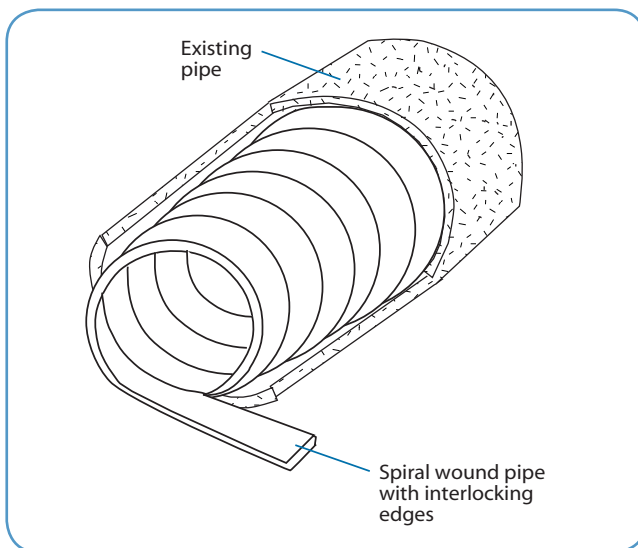

Figure 1. Schematic of a spiral wound lining.

Cured-in-Place Pipe

During CIPP rehabilitation, a flexible fabric liner coated with a thermosetting resin is inserted into the existing sewer and then cured (EPA 1999). The most common techniques for installing the liners are the winch-in-place and invert-in-place methods. In the former, a winch is used to pull the liner into place. The liner is then filled with air to push it against the existing pipe. When using the invert-in-place technique, the resin is applied to the inside of the liner. Water or air pressure is used to invert the liner so that the resin covered side “flips out” to meet the existing pipe. For both methods, heat is used to seal the liner to the pipe (EPA 1999). CIPP liners can be installed from existing

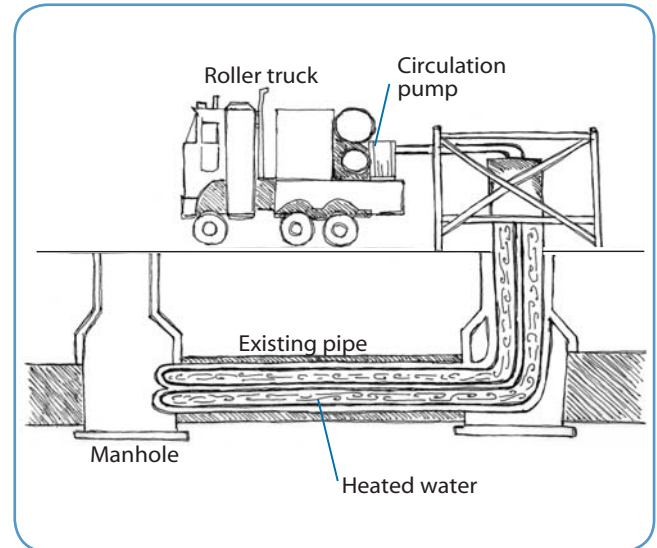

Figure 2. Schematic of a cured-in-place technique (O'Brien and Gere 2002)

manholes, making it a true trenchless technology, as shown in Figure 2.

Modified Cross Section Lining

Modified cross section lining rehabilitation methods modify the cross-sectional area of the liner to facilitate its installation. The three most common techniques are Swagelining™, deform and reform, and roll down. Swagelining™ uses heat and a chemical dye to reduce the size of the liner. After the liner is pulled through the pipe and allowed to cool, it returns to its original diameter. In the deform and reform method, a flexible pipe is deformed, often forming a U shape, and is then inserted into the existing pipe. The roll down technique minimizes the size of the liner using a series of rollers. Heat is used to reform the liner for both the deform and reform and roll down methods (EPA 1999).

Pipe Bursting

Pipe bursting uses the existing pipe as a guide for an expansion head. A cable rod and winch pull the expansion head, which cracks the existing pipe by pushing it radially outwards. The new sewer line is pulled behind the expansion head, as shown in Figure 3. Expansion heads are either static or dynamic; the dynamic head provides additional pneumatic or hydraulic force to counter the pressure created by pulling the expansion head through the existing pipe (EPA 1999).

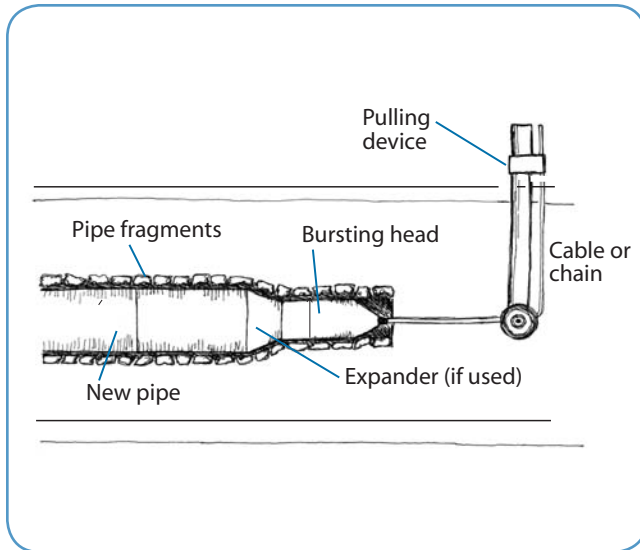

Figure 3. Schematic of pipe bursting technique.

Key Considerations

Applicability

In selecting a sewer rehabilitation technique, site-specific conditions, project goals, and sewer system characteristics should be evaluated. Inspection and evaluation of the current sewer condition are necessary before a sewer rehabilitation technique is chosen, as the condition of the sewer may favor specific techniques. Additional information on sewer inspection techniques is provided in the “Sewer Testing and Inspection Technology Description” located in Appendix B of *Report to Congress on the Impacts and Control of Combined Sewer Overflows and Sanitary Sewer Overflows*.

Removing and Replacing Defective Lines

Removing and replacing defective lines is the most commonly used rehabilitation technique when the sewer line is structurally deficient. Replacing defective lines results in a line segment design life that exceeds any other rehabilitation method. Also, in areas in need of increased conveyance capacity, complete replacement provides an opportunity for installation of a larger-diameter sewer (WEF 1999). Sewer replacement can be quite disruptive to automotive and pedestrian traffic, however. Construction times and service interruptions for replacement are typically lengthy compared to other rehabilitation methods. In addition, sewer flows must be rerouted during construction. Construction costs are also considerably higher for dig-and-replace than for other rehabilitation methods (EPA 1991).

Shotcrete

Shotcrete is often used to rehabilitate sewers with major structural problems. As with dig-and-replace, flow must be completely diverted during construction since equipment and personnel must access the pipe. Shotcrete may only be used in pipes with a diameter greater than 36 inches.

The advantages of using shotcrete include (CSU 2001):

- Rehabilitation can be accomplished using manholes to access the sewer system;
- Restoration of the original pipe strength; and
- Method is safer for crews than grouting and epoxy injections.

Disadvantages of shotcrete include (CSU 2001):

- A long curing time;
- Complete diversion of the flow during application; and
- Reduction in hydraulic capacity because the diameter of the sewer is reduced.

Trenchless Technologies

Trenchless technologies are especially well-suited to urban areas where the traffic disruption associated with large-scale excavation projects can be a significant obstacle to a project (WEF 1999). In addition, many sewers are located near other underground utilities in urban areas which can

Table 1. Sewer system characteristics for trenchless technologies (CSU 2001).

Method	Diameter Range (in.)	Maximum Installation (ft.)
<u>Grouting and Epoxy Injections</u>		
Remote Application		
Manual Application		Not Available
<u>Sliplining</u>		
Continuous	4-63	1,000
Segmented	12-158	5,600
Spiral wound	4-100	300
<u>CIPP</u>		
Invert-in-Place	4-54	500
Winch-in-Place	4-100	3,000
<u>Modified Cross Section Liners</u>		
Swagelining™	4-24	300
Deform and Reform	4-64	300
Rolldown	4-24	300
<u>Pipebursting</u>		
Pneumatic Head	2-24	475
Static Head	4-24	650

complicate traditional dig-and-replace methods; trenchless technologies avoid underground utilities.

Advantages of trenchless technologies include (EPA 1999):

- Reduced air pollution from construction equipment
- Fewer traffic detours
- Decreased construction noise
- Reduced vegetation disturbance
- Limited areas where safety concerns must be identified

Table 1 highlights conditions for which various trenchless technologies are most applicable. Trenchless technologies are not without limitations, however, and they are summarized in Table 2.

Table 2. Disadvantages of trenchless sewer rehabilitation technologies (EPA 1999).

Method	Disadvantage
Grouting and Epoxy Injections	<ul style="list-style-type: none"> • Utilize harsh chemicals that may be dangerous for installation crews • Will not prevent further pipe movement, and may crack if pipe shifts
Sliplining	<ul style="list-style-type: none"> • Requires an insertion pit • Reduces pipe diameter • Cannot be used with small diameter pipes
CIPP	<ul style="list-style-type: none"> • Curing can be difficult for long pipe sections • Requires diversion of flow • Resin can clump together • Reduces pipe diameter
Modified Cross Section Liners	<ul style="list-style-type: none"> • Liner may shrink after installation
Pipe Bursting	<ul style="list-style-type: none"> • Infiltration may occur between pipe and liner • Liner may not provide adequate structural support • Requires diversion of flow • Reduces pipe diameter
Pipe Bursting	<ul style="list-style-type: none"> • Insertion pit needed • Dynamic head may cause soil settling around the newly installed pipe • Requires diversion of flow • Not suitable for all pipe materials

Cost

Selection of a cost-effective sewer rehabilitation technique depends on the present condition of the sewer and other site-specific considerations. In general, grouting is the least expensive of the sewer rehabilitation methods presented. Further, trenchless sewer rehabilitation techniques are often less expensive than open-cut methods because the amount of excavation for the trenchless technology is minimal (EPA 1999). A representative range of costs for several trenchless technologies (CIPP, sliplining, and pipe bursting) is presented in Table 3; actual costs for sewer rehabilitation projects undertaken by a number of municipalities are summarized in Table 4. As shown in Table 4, there is considerable variation in the cost per foot for an individual technology; the diameter of the pipe drives much of this variation. Figure 4 illustrates the increase in cost of CIPP replacement as a function of increasing sewer diameter.

Table 3. Cost of selected trenchless technologies.

Technology	Cost (\$/foot)
CIPP	42-1200
Sliplining	10-560
Pipe Bursting	46-260

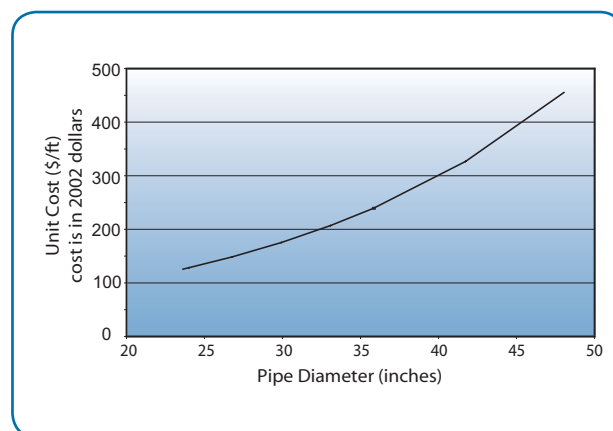

Figure 4. CIPP cost versus pipe diameter (Zhao et al. 2001).

Table 4. Costs of municipal sewer rehabilitation projects.

Municipality	Technology	Project Characteristics	Year Constructed	Costs ¹
Buffalo, NY	Shotcrete	Shotcrete was applied to 1,465 linear feet of the Military Road sewer that was over 50 years old. The pipe diameter tapered down from 53 to 48 inches.	1997	Approximate cost: \$280,552 or \$192 per foot
Indianapolis, IN	Shotcrete Trenchless	After sewer evaluation was performed a total of 12,495 feet for sewer have been rehabilitated using Shotcrete, CIPP, and sliplining.	1998-2002	\$4 million or \$317 per foot
St. Louis, MO	Open-Cut	1,560 feet of sewer were replaced, providing surcharge relief to upstream sewer system. Costs include all excavation, refill, and engineering costs.	2002	\$535,000 or \$343 per foot
Austin, TX	Open-Cut Trenchless	The Austin Clean Water Program is a comprehensive project to eliminate SSOs from the city's sanitary sewer system. The project will be complete by 2007.	2002 (construction started)	Cost for Crosstown Tunnel Service Area: \$44 million or \$530 per foot
Torrence, CA ²	Open-Cut Trenchless	8,400 feet of pipe was rehabilitated. 90 percent of the sewers were repaired using machine spiral wound PVC pipe liner. Open-cut methods were used for the remaining sewers.	2002	Total construction cost: \$530,000 Open-cut: \$191,000 or \$955 per foot Trenchless: \$339,000 or \$41 per foot
DuPage County, IL	Trenchless	U-liner to rehabilitate 24,000 feet of 8-inch and 4,000 feet of 10-inch VCP mains.	1994	8- to 12-inch U-Liner: \$34-\$44 per foot
Glendale, WI	Trenchless	U-Liner was used to repair 3,462 feet of eight to 10 inches pipes; CIPP was used for 1,966 feet of 15-inch pipes..	1999	8-to 10-inch U-Liner: \$29-\$33 per foot 15-18 inches CIPP: \$58-68 per foot
Muscatine, IA	Trenchless	CIPP method was used to rehabilitate 3,800 feet of 24- to 27-inch diameter pipes and 187 feet of 8-inch clay pipes.	2001	24-to 27-inch CIPP: \$67-\$103 per foot
South Fayette Township, PA	Grouting	Pilot program grouting a total of 2,788 feet was conducted. A total of 303 gallons of acrylmide grout was used.	1997	\$33,475 or \$12 per foot
Dallas, TX	Grouting	Approximately 10,000 feet of pipe were cleaned, tested, and sealed as part of a project to eliminate I/I.	2000	\$89,331 or \$9 per foot

¹ All costs are converted to 2002 dollars based on the ENR Construction Cost Index² Costs include traffic control, which increase the cost per linear foot; total construction cost was \$530,000 (Ringland 2003)

Implementation Examples

AUSTIN, TX

Responsible Agency: City of Austin Water and Wastewater Utility

Population Served: 1 million

Service Area: 364 sq. mi.

Sewer System: 2,262 mi. of sewer

Clean Water Program to Control SSOs

In April 1999, the City of Austin received an Administrative Order from EPA requiring it to eliminate SSOs by 2007. The order stemmed from a review of Austin's sewer system performance following a 170,000 gallon SSO to Bushy Creek, a tributary of the San Gabriel River. To comply with the order, the city created the Austin Clean Water Program. The order requires inspection of approximately 40 percent of the city's 2,200 mile sewer system, and, where appropriate, the rehabilitation of failing sewer lines. The project is broken

up into three areas, Crosstown Tunnel Service Area, Onion Creek Service Area, and Govalle Tunnel Service Area, which are being inspected and rehabilitated in a phased approach. To date, 500,000 linear feet have been rehabilitated using sliplining and open-cut methods.

The total cost estimate for the Austin Clean Water Program is \$150 million, which includes an I/I study and sewer system evaluation and rehabilitation projects in each service area. Estimated cost for the rehabilitation completed in the Crosstown Tunnel Service Area is approximately \$44 million or \$530 per linear foot.

More information at <http://www.ci.austin.tx.us/acwp/>

MIAMI, FL

Responsible Agency: Miami-Dade Water and Sewer Department

Population Served: 2.1 million

Service Area: Not Available

Sewer System: 2,441 mi. of gravity sanitary sewer

I/I and Rehabilitation Program

The Miami-Dade Water and Sewer Department (MDWASD) initiated an infiltration/inflow and rehabilitation (I/I & R) program in 1995 in response to an EPA consent decree. The I/I & R program established an ongoing sewer evaluation and rehabilitation schedule to preserve the sewer system's integrity and maintain acceptable levels of I/I. The I/I & R program includes sewer cleaning, CCTV

inspection, smoke testing, dye water flooding, and system rehabilitation.

Approximately 14.5 million feet of sanitary sewer have been inspected and rehabilitated. Sewer rehabilitation methods include dig-and-replace, sliplining, and grouting. Over 32,000 repairs have been completed, helping to reduce SSO volumes by 90 percent and I/I by an estimated 118 MGD since program inception. MDWASD believes the I/I & R program is working; for example, in June and July 2002, the area received more than 20 inches of rain, but the sewer system experienced no capacity-related SSOs. The total cost of the I/I & R program, since its inception, has been approximately \$174 million or \$12 per foot of sewer inspected or rehabilitated.

More information at <http://www.co.miami-dade.fl.us/wasd/>

COLUMBUS, OH

Responsible Agency: Department of Public Utilities, Division of Sewage and Drainage

Population Served: 1 million

Service Area: 219 sq. mi.

Sewer System: 4,000 mi. of sanitary and combined sewer

Sewer Inspection and Rehabilitation Program

In 1995, the City of Columbus initiated a sewer line inspection and rehabilitation program. To assure the quality of products used by contractors in the program, the city developed a list of approved rehabilitation technologies. When a new technology or product of interest emerges, the manufacturer may request to have their product added to the approved list. The city has developed a process to standardize the introduction of new products. The process requires that:

- The products meet and conform to American Society for Testing and Materials (ASTM) and other professionally recognized standard specifications.
- The products must have been used successfully by three municipalities over a minimum of three years.
- The city visits both construction sites and product manufacturing facilities to inspect operation and observe standard construction practices.
- The manufacturer provides information on the expected service life of the product with supporting data.

When a product is selected for preliminary review, it is installed in a small portion of the city's sewer system. The product's effectiveness is then monitored for three years. Once the product is judged effective, it can be placed on the list of approved technologies. The current list of approved technologies includes several CIPP products, sliplining, and shotcrete. These technologies have been utilized to repair numerous sections of structurally impaired combined sewers. The city has recently started rehabilitating sanitary sewers using the approved technologies.

Sewer rehabilitation is a priority for Columbus, and the program has been funded accordingly. The dollars spent on sewer rehabilitation between 1996 and 2001 are shown in the table on the right. Costs presented do not include construction, administration, and inspection costs.

Year	Construction Dollars Spent ¹ (Millions)
1996	\$6.5
1997	\$2.6
1998	\$5.9
1999	\$2.6
2000	\$6.8
2001	\$9.3

¹ All costs are converted to 2002 dollars based on the ENR Construction Cost Index

Contact: Miriam Siegfried, Department of Public Utilities, City of Columbus

HOUSTON, TX

Greater Houston Wastewater Program

Responsible Agency: City of Houston
Department of Public Works and Engineering

Population Served: 1.9 million

Service Area: 600 sq. mi.

Sewer System: 5,000 mi. of sanitary sewer

In 1987, the Texas Natural Resource Conservation Commission and EPA mandated that Houston eliminate the 200 known SSO points that were part of their sanitary sewer system by 1997. The first step the city took was to inspect over 27 million linear feet of sewer. The results of the inspections were used to rate each sewer segment. The rating took into account the severity of I/I, roots, concrete deterioration, and structural defects. The inspection program found that 50 percent of the inspected sewer segments were in need of rehabilitation or replacement.

To help prioritize the numerous rehabilitation projects, the city developed a numeric sewer rehabilitation rating system, which considered:

- Accessibility of the line
- Potential future capacity requirements
- Surrounding environment
- Cost

Prior to rehabilitation, a second analysis was performed to determine the most appropriate technique. The analysis considered:

- Current condition of the sewer line
- Maximum service capacity
- Hydraulics
- Site constraints

In areas that were fully built-out, with no future plans for redevelopment, trenchless technologies were generally used for sewer rehabilitation. Where trenchless technologies were utilized, a hydraulic analysis was performed to determine if reducing the inner diameter of pipe would cause capacity constraints that could lead to SSOs. For sewers where the use of trenchless technologies yielded an unacceptable reduction in pipe diameter, or areas where undeveloped land was still available, lines targeted for rehabilitation were typically replaced with a larger pipe to add additional capacity.

Technologies approved for use by the city included sliplining, cured-in-place pipe, pipe bursting, and limited use of modified cross-section liners. The city rehabilitates approximately 120 miles of sewers annually using trenchless technologies. The city committed to spend a total of \$300 million on sewer rehabilitation as part of the settlement with EPA.

Contact: Teresa Battenfield, City of Houston, Department of Public Works and Engineering

INDIANAPOLIS, IN

Combined Sewer Infrastructure Assessment

Responsible Agency: City of Indianapolis
Department of Public Works

Population Served: 800,000

Service Area: 58.4 sq. mi.

Sewer System: 82.2 mi. of combined sewer

The Indianapolis Combined Sewer Infrastructure Assessment Project investigated the integrity of approximately 50 miles of sewer with diameters of 60 inches or larger. The city used the study to identify sewers in need of immediate rehabilitation and to develop the basis for a more integrated Capital Improvement Program. This project was also important to the city in developing its CSO long-term control plan. The city wanted to maximize storage in the existing sewer system, but needed to be sure that the pipes

used to store flows were structurally sound. If a weak sewer pipe was stressed to the point of failure in using it for storage, the environmental impacts could be much larger than those attributed to a single CSO event. Approximately 253,000 feet of brick, concrete, and vitrified tile combined sewer were physically inspected and rated based on their structural integrity between 1994 and 1998. The study found that the majority of sewers were in good condition, identifying approximately 71,000 feet (28 percent of the assessed length) in need of rehabilitation. Since the Assessment Project was completed in 1998, a total of 12,495 feet of sewer have been rehabilitated. The city has used shotcrete, CIPP, and sliplining techniques to rehabilitate their large diameter combined sewers.

The total cost for the Assessment Project was \$1.1 million. An additional \$4 million or \$317 per foot has been invested in targeted sewer rehabilitation.

Contact: T.J. Short, Greeley and Hansen

References

EPA. 1991. *Sewer System Infrastructure Analysis and Rehabilitation*. EPA 625-6-91-010.

EPA. 1999. *Collection Systems O&M Fact Sheet: Trenchless Sewer Rehabilitation*. EPA 832-F-99-032.

California State University (CSU), Sacramento - College of Engineering and Computer Science, Office of Water Programs. 2001. *Operation and Maintenance of Wastewater Collection Systems*. Vol. 1, 5th ed. Prepared for EPA Office of Water Programs, Municipal Permits and Operations Division. Sacramento, CA: CSU, Sacramento Foundation.

National Research Council Canada (NRC). 2002. *Construction and Rehabilitation Costs for Buried Pipe with Focus on Trenchless Technologies*. Research Report No. 101. Ottawa, Canada: National Research Council Canada.

O'Brien & Gere. 2002. 'Wastewater Management: Trenchless Technologies.' Viewed December 17, 2002.

[http://www.obg.com/wastewater/pdf/Trenchless_Syr\(1\).pdf](http://www.obg.com/wastewater/pdf/Trenchless_Syr(1).pdf)

Shotcrete Technologies, Inc. 2001. "Shotcrete Tips and Tricks: Mix Design and Quality Control." Retrieved February 21, 2003.

<http://www.shotcretetechnologies.com/tips.html>

Ringland, David, City of Torrence. Interview with Limno-Tech, Inc., March 2003. Washington, DC.

Water Environment Federation (WEF). 1999. *Prevention and Control of Sewer System Overflows: WEF Manual of Practice No. FD-17*. Prepared by Gray, W. et al. Alexandria, VA: Water Environment Federation.

Zhao, J. Q. et al. 2001. *Guidelines for Condition Assessment and Rehabilitation of Large Sewers*. Ottawa, Canada: Institute for Research in Construction, National Research Council Canada. Report No. NRCC-45130.

Inclusion of this technology description in this Report to Congress does not imply endorsement of this technology by EPA and does not suggest that this technology is appropriate in all situations. Use of this technology does not guarantee regulatory compliance. The technology description is solely informational in intent.



Installing cured-in-place lining (Reynolds's Inc.)

TECHNOLOGY DESCRIPTION

Collection System Controls

Service Lateral Rehabilitation

Overview

Private building service laterals (herein referred to as “service laterals”) are the pipe or pipes used convey wastewater from individual buildings to the municipal sewer system. Typical service laterals are four to six inches in diameter, with lengths ranging from 15-100 feet. Service laterals are often thought of in two segments: the upper lateral, which includes the section of pipe between the building and private property boundary; and the lower lateral, which includes the section of pipe between the private property boundary and the municipal sewer system.

For many years, the effect of leaking service laterals was considered insignificant because it was assumed that most service connections were above the water table, and therefore, subject to infiltration only during periods of excessive rainfall or high groundwater levels (EPA 1991). More recent studies indicate that a significant component of the infiltration in any sewer system is the result of service lateral defects that contribute varying quantities of inflow and infiltration (I/I) to the sewer system. Many of these defects are traceable to poor design, pipe selection, and improper construction (WEF 1999). Further, fluctuating groundwater levels, variable soil characteristics and conditions, traffic, erosion, and washouts stress service lateral pipes and joints. As shown in Figure 1, the most common problems found in service laterals include:

- Improper connections
- Faulty pipe joints
- Root intrusion
- Failure of service lateral bedding or backfill to support the pipe
- Pipe material failure in aging service laterals
- Missing or broken cleanout caps

Service lateral testing is an important first step in any rehabilitation program. Testing is used to assess the structural condition of the service lateral and to help locate defects. Additional information on sewer testing practices is

provided in the “Sewer Testing and Inspection Technology Description” in Appendix B of *Report to Congress on the Impacts and Control of Combined Sewer Overflows and Sanitary Sewer Overflows*.

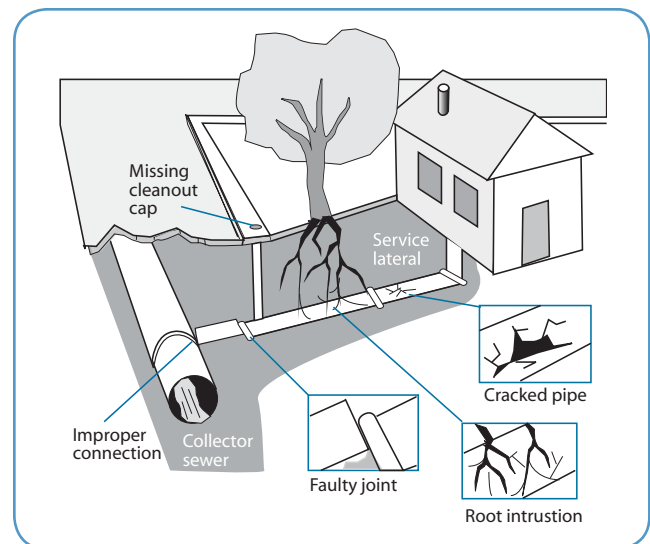

Figure 1. Common defects in service laterals.

There are a number of techniques available for repairing defective service laterals. These include:

- Removing and replacing defective service laterals
- Spot repairs
- Trenchless technologies
- Eliminating inflow sources

These four techniques are discussed in some detail below.

Removing and Replacing Defective Service Laterals

In many cases, it is not practical or desirable to rehabilitate existing sewers. Removing and replacing part or all of a defective service lateral is the most common and proven method for eliminating I/I from private property. A key factor to a successful program using remove and replace is

obtaining the private property owners' consent to access the property for construction.

Spot Repairs

Spot, or point, repairs are typically used to correct isolated or severe problems in relatively short portions of a service lateral. Spot repairs can also be made as an initial step in the use of other rehabilitation methods (NASSCO 1996). Spot repairs can be made using either open cut or trenchless technologies. The open-cut technique involves excavating and removing the defective section, and then installing new pipe with proper seals to ensure watertight connections to the existing service lateral and/or municipal sewer system. Trenchless technologies for spot repairs typically use epoxy or resin to fill defects; in general, their use is limited to service laterals with a diameter of six inches or more.

Trenchless Technologies

Trenchless service lateral rehabilitation uses the existing pipe to support a new pipe or a liner. Generally, the use of trenchless technology methods is neither as widespread nor extensive as open cut techniques for repairing service laterals (WEF 1999). As the name implies, trenchless technology requires less surface interruption than complete replacement of a defective line. Therefore, trenchless technologies show particular promise in areas where construction impacts on trees, shrubbery, and other landscaping materials would make open-cut service lateral repair costs prohibitive. Trenchless rehabilitation techniques include lining, cured-in-place pipe (CIPP), pipe bursting, grouting, and epoxy injections.

Lining Service Laterals

Lining service laterals is typically used to extend the life of an existing service lateral by increasing its strength and/or protecting it from corrosion or abrasion (NASSCO 1996). Lining involves sliding a flexible liner pipe of slightly smaller diameter into the existing lateral. The space between the liner and the existing service lateral is then grouted. Lining is most often used to rehabilitate extensively cracked laterals, especially those in unstable soil conditions. The most popular materials used to line sewers are polyolefins, reinforced thermosetting resins, and PVC (EPA 1991). The lateral must be thoroughly cleaned prior to lining. Typically, lining the service lateral requires excavating an entry point at both upstream and downstream ends to be able to insert and move the liner into position. Therefore, similar to remove and replace and open-cut spot repairs, lining service laterals requires private property access.

Cured-in-Place Pipe

The cured-in-place pipe (CIPP) process involves installing and curing a resin-saturated, flexible fabric liner inside the service lateral. The liner is installed using air or water inversion or a pull-in process. With water inversion, the lining is inverted using water pressure; air inversion uses air pressure to invert the liner. The pull-in process involves winching the liner into place and using an air bladder to "inflate" the liner. The liner is then cured by circulating low pressure hot water or steam. The lateral must be thoroughly cleaned prior to installing the CIPP, and areas with excessive infiltration must be sealed. Typically, installing CIPP liners requires excavating an entry point at either the upstream or downstream end. Therefore, installing CIPP liners may not require private property access.

Pipe Bursting

Pipe bursting replaces the existing lateral with a pipe of similar or larger diameter by fragmenting the existing pipe into the surrounding soil, thereby creating a cavity for the new pipe. Pipe bursting has been used in the gas industry for some time, but only more recently has been looked at for rehabilitating service laterals. Similar to lining a lateral, excavated entry points at both the upstream and downstream ends of the service lateral are required, which requires private property access.

Grouting and Epoxy Injections

Grouting and epoxy injections are most commonly used for sealing leaking joints in pipes that are otherwise structurally sound (NASSCO 1996). Small holes and radial cracks may also be sealed by grouting or epoxy injections. Grouts and epoxies are applied internally within a pipe and are a trenchless rehabilitation method.

Eliminating Inflow Sources

Service lateral cleanouts allow access to the lateral for routine maintenance. Often, the cap used to prevent storm water inflow into the service lateral at the cleanout is broken or missing. One study found that almost 25 percent of service lateral defects were related to missing or damaged cleanout caps (Rowe and Holmberg 1995). Replacing missing or defective cleanout caps can result in substantial reductions in inflow into the sewer system.

Although disconnecting inflow sources is not a repair of the service lateral per se, elimination of direct

connections of extraneous storm water is important. Other, often significant inflow sources include:

- Roof leaders
- Area, foundation, yard, patio, and driveway drains
- Basement sump pumps
- Cross-connections to separate storm sewers

Additional information on disconnecting inflow sources is provided in the “Inflow Reduction Technology Fact Sheet” in Appendix B of *Report to Congress on the Impacts and Control of Combined Sewer Overflows and Sanitary Sewer Overflows*.

Key Considerations

Applicability

Assigning responsibility for the repair or replacement of service laterals has often been cited as the biggest obstacle to correcting known defects. Notably, several studies highlighted significant problems in gaining access to private property until the municipality assumed full financial responsibility for the repair or replacement of service laterals (Curtis and Krustsch 1995; Paulson *et al.* 1984).

Removing and Replacing Defective Service Laterals

The removal and replacement of a service lateral is usually more expensive than other rehabilitation methods. Replacing a defective service lateral, however, ensures that the design capacity of the lateral is maintained, whereas rehabilitation may result in an unacceptable reduction in capacity. Construction activities associated with removal and replacement involve a greater risk of damage to or interruption of other utilities than most trenchless lateral rehabilitation techniques.

Spot Repairs

Spot repairs are often a cost-effective means of addressing minor defects in service laterals. While spot repairs eliminate infiltration at the location of the repair they are typically not an appropriate approach for rehabilitating a lateral with multiple defects. Without correcting all of the defects in a given lateral, groundwater will simply find another location to enter the pipe. Depending on the number and type of defects in a given lateral, it may be more cost-effective to address the infiltration by rehabilitating the entire length of the lateral.

Trenchless Technologies

Trenchless sewer rehabilitation techniques require substantially less construction work than traditional remove-and-replace methods (EPA 1999). However, with

the exception of pipe bursting, trenchless technologies reduce the lateral diameter, resulting in decreased capacity.

Lining Service Laterals

To date, there has been limited experience using liners to rehabilitate service laterals, although application is expected to increase (WEF 1999). In lining service laterals, particular attention must be paid to local plumbing codes, specifically, whether changes will be required to accommodate the reduced interior diameter of the lateral after it is lined.

Pipe Bursting

The primary advantage of pipe bursting is that the flow carrying capacity of the existing lateral does not have to be reduced; further, pipe bursting allows the new lateral to be up-sized, if needed. In addition, the amount of surface disruption associated with pipe bursting is less than that required for total lateral replacement. The soil type surrounding the existing lateral is an important variable when considering pipe bursting. In soils that are predominated by sand, the soil “relaxes” almost instantaneously onto the new pipe causing very slow progress. It is also important to ensure that no large boulders or rock formations are located in the path of the pipe bursting equipment. Finally, the forces exerted by the bursting equipment may adversely affect other pipes near the lateral being replaced. Unit replacement costs with pipe bursting are typically 20-40 percent lower than traditional open cut methods.

Cured-in-Place Pipe

The use of CIPP for rehabilitating laterals with diameters as small as four inches is common (NASSCO 1996). Unlike other types of lining, CIPP does not require grouting. Although the installation of a CIPP liner is rapid, the curing period can be extensive, and flow and groundwater infiltration in the lateral will need to be controlled during installation. CIPP also has relatively high set-up costs for small projects.

Grouting and Epoxy Injections

Grouting is relatively inexpensive. Grouting does not improve the structural strength of the lateral, and for that reason, should not be considered when the pipe is severely cracked, crushed, or badly broken (EPA 1991). Epoxy injections, although similar to grouting in most respects, provide the added benefit of improving somewhat the structural integrity of the rehabilitated pipe. Because epoxy is more viscous than grout, it cannot be pumped as far (WEF 1999). The service life of grout is an important consideration. The average service life of grouts is seven years (NASSCO 1996).

Grouting requires flow control, because the section being grouted cannot transport flow until the grout has cured. Therefore, it is also difficult to line service laterals if infiltration is present. Most coatings cannot be successfully applied to either water leaks or ponded water (NASSCO 1996). Large cracks, badly offset joints, and misaligned pipes may not be sealable using grouts or epoxies.

Eliminating Inflow Sources

Eliminating sources of inflow can be an efficient way to reduce the volume of storm water delivered to both combined and separate sanitary sewer systems. The feasibility of disconnecting inflow sources depends on the soil type, land slope, and drainage conditions around the home. Additionally, for an inflow disconnection program to be successful, the public must be educated about the benefits of and the methods for disconnecting sources. This can be time-consuming and will likely require some sort of rebate program or other incentive for compliance.

Cost

Often, very little specific data are available to compare the I/I contribution from service laterals with that from other sewer system components. Flow meters are rarely used to monitor individual service laterals for reasons including it is physically difficult to isolate service laterals from the sewer system for installing flow meters; placing flow meters in a service lateral requires significant and often expensive modifications; and the large number of service lateral

connections can make sampling representative locations costly. Rehabilitating service laterals, however, has proven to be a critical component of an I/I reduction program. Studies have found that service lateral rehabilitation can reduce the introduction of extraneous I/I into the sewer system from 45-87 percent (Rowe and Holmberg 1995; Curtis and Krustsch 1993; EPA 1985; Roberts 1979). Actual I/I reductions achieved, however, are dependent on a number of factors, and therefore the cost-effectiveness of lateral rehabilitation will vary from community to community.

Costs associated with the various techniques available for rehabilitating or replacing service laterals vary considerably and are driven by site-specific conditions. Table 1 presents the relative costs of the various techniques discussed in this technology description. For example, replacing a service lateral, either using open cut or pipe bursting techniques, is almost always more expensive than other rehabilitation alternatives. The exact cost of replacing the lateral, however, will be driven by the landscape and length of the lateral among other factors.

Table 1. Relative cost of various service rehabilitation costs.

Technique	Relative Cost
Removing and replacing service laterals	\$\$\$\$
Spot repairs	\$
Lining service laterals	\$\$
Pipe bursting	\$\$\$
Grouting and epoxy injections	\$\$
Eliminating inflow sources	\$\$

Implementation Examples

DARIEN, IL

Responsible Agency: DuPage County Public Works Division

Population Served: 585 single family homes

Hinsbrook Subdivision I/I Rehabilitation

In the early 1990s, the DuPage County Public Works Division initiated efforts to control I/I in the Hinsbrook Subdivision, which suffered from frequent SSOs. A study of the sewer system determined that 25-30 percent of the I/I was entering from the sewer system service laterals. Rehabilitation of the service laterals was necessary, but politically complicated as it involved coordinating three groups:

the Public Works Division of DuPage County, the Public Works Department of the City of Darien, and the property owners. DuPage County owns the SSS, while the City of Darien is responsible for storm water control in the subdivision, and property owners are responsible for the portion of the service lateral on their property.

Pipe bursting was used to rehabilitate the majority of the service laterals in the subdivision. Property owners were informed in advance of the replacement and given the option of hiring their own contractor or allowing the county to make the needed repairs. Only 35 homeowners chose to hire their own contractor. For the pipe bursting, a small pit was excavated at the foundation of each home. The pipe bursting head and new pipe were pulled with a winch from a pit located near the main pipe. The new service lateral was then connected to the house and the service main. Installation time averaged two hours limiting the time service was interrupted. Property owners who chose to have the county rehabilitate their service lateral paid the county \$966.

More information at <http://www.dupageco.org/publicworks/index.cfm>

MONTGOMERY, AL

I/I Tracking and Service Lateral Rehabilitation

Responsible Agency: Montgomery Water Works and Sanitary Sewer Board

Population Served: 225,000

Service Area: 150 sq. mi.

Sewer System: 1,098 mi. of sewer

Montgomery Water Works and Sanitary Sewer Board (MWWSSB) evaluated the condition of its sewer system in the early 1990s and discovered inflow sources could be cost-effectively eliminated in 86 percent of the system. Nearly 2.2 million linear feet of pipe were investigated in the first five years of the program. Of the 3,394 sewer system problems detected, 85 percent were service lateral problems; a defect was found in approximately every 700 feet of sewer inspected. Of

the 113 subbasins served by MWWSSB, 35 were smoke tested in the first six years of the program; 97 percent of the lateral defects identified have been repaired.

Lateral maintenance and repair has always been the responsibility of the property owner, who was notified when defects were discovered. Due to the number of defects identified, MWWSSB adopted a more aggressive maintenance and repair policy. Property owners initially received a 60-day notice of the lateral repair requirements. If they failed to respond to the initial notice, a 10-day notice was sent to the property owner. Finally, if the property owner had not responded to either notice, their water service was shut-off.

Lateral repairs necessary within the city street right-of-way are made by MWWSSB with consent and release of liability from the property owner. MWWSSB also replaces missing clean-out covers for a minimal cost with written permission from the property owner.

To help manage the numerous service lateral repairs, MWWSSB created a sewer maintenance database. The database includes information regarding when smoke testing was initiated, any defects found during testing, digital photos of the defect, when the first owner notice was generated, and any repairs that were performed.

The public notice process was implemented in the Fall of 1994; 65 percent of property owners responded after receiving the 60-day notice. The remaining property owners repaired their defects under threat of having their water service discontinued. In selected subbasins where service lateral rehabilitation is complete, a 42 percent reduction of I/I has been measured. It is estimated that the annual I/I volume in the MWWSSB service area has been reduced by 36 million gallons. The initial cost of establishing the I/I program was approximately \$150,000; MWWSSB annual program operation costs are \$207,000.

Contact: Danny Holmberg, Montgomery Water Works and Sanitary Sewer Board

ORLANDO, FL

Lateral Lining Program

Responsible Agency: City of Orlando Public Works Department, Wastewater Bureau

Population Served: 200,000

Service Area: 104 sq. mi.

Sewer System: 500 mi. of sanitary sewer

The City of Orlando Public Works Department (PWD) is responsible for the maintenance and repair of the city's sewer system. Service laterals in the sewer system are made from several different materials, including clay (45 percent), PVC (35 percent), and concrete (20 percent). PWD found that the clay and concrete pipes were particularly prone to I/I problems and that root intrusion was the most common defect in service laterals.

PWD began to excavate and replace laterals from the property line to the main sewer. Excavation was expensive and disturbed the local landscape and traffic patterns, frustrating residents. PWD looked into various trenchless technology options and selected CIPP liners installed using an air inversion system to rehabilitate laterals.

PWD only rehabilitates laterals from the property line to the main sewer. Lateral rehabilitation begins when city crews excavate the lateral at the property line. The crew then performs an initial inspection, and the proper length of liner is prepared and impregnated with resins. The liner is installed into the host pipe by inflating a bladder that forces the liner into the pipe and causes it to adhere to the walls of the host pipe. After a two-hour curing period, the bladder is deflated and removed. After a final inspection, the pipe is reconnected and the excavation site is resodded. It is estimated that this process takes four to five hours per lateral. It is believed that this system will help mitigate SSOs by controlling I/I into the system and will reduce service calls. The equipment for this program cost \$21,500, and it is estimated that rehabilitation will cost \$800 per lateral.

Contact: Ron Proulx, Public Works Department, City of Orlando

SAN LUIS OBISPO, CA

Voluntary Service Lateral Program

Responsible Agency: City of San Luis Obispo Utilities Department

Population Served: 44,613

Service Area: 10.7 sq. mi.

Sewer System: 130 mi. of combined sewer

The City of San Luis Obispo was experiencing I/I problems during their rainy season. At the time, the city treatment plant was suffering from wastewater flows that would increase from a daily average of 4.5 MGD to over 30 MGD during wet weather events, pushing the city's wastewater treatment facility over its design limit. A flow monitoring study of the city sewer system was conducted to identify the extent of I/I and its sources.

Flow monitoring data showed that a residential area served by sewers built between 1930 and 1965 was the major contributor of I/I. The city then video inspected the sewer mains to determine the locations of the I/I within this area. The inspection phase occurred from 1991-1994 and concluded that service laterals were the main source of the I/I. A small sample of laterals revealed that failures were mainly due to aging construction materials and failed mortar joints, particularly where laterals were constructed from orangeburg or clay pipe. Service lateral defects identified included root intrusion, misaligned joints, broken pipes, holes, and missing pipes. Based on these findings, the city adopted and implemented the Voluntary Sewer Lateral Rehabilitation Program (VSLRP) in 1997.

The VSLRP was developed to mutually benefit the city and homeowners. Homeowners who participate in the program received free lateral inspection, construction permits, technical advice, and a rebate of half the cost of the replacement or repair up to \$1,000 per property from the city. The lateral rehabilitation methods used by the city were removal and replacement, the most popular method, as well as trenchless rehabilitation methods of pipe bursting and lining.

More information at http://www.ci.san-luis-obispo.ca.us/utilities/vslrp_technical.asp

References

Curtis, N. M., and Krustsch, A.H. "Trying on Flow Reduction for Size." *Water Environment Technology*. 3 (No. 4): 48.

Curtis, N. M., and Krustsch, A.H. 1995. *Sewer Rehabilitation Using Trenchless Technology on Mainlines and Service Laterals*. Conference proceedings at Water Environment Federation WEFTEC, Anaheim, CA. October 1993.

EPA. 1985. *Demonstration of Service Lateral Testing and Rehabilitation Techniques*. Prepared by C. H. Steketee. EPA 600-2-85-131.

EPA. 1991. *Sewer System Infrastructure Analysis and Rehabilitation*. EPA 625-6-91-030.

EPA. 1999. *Collection Systems O&M Fact Sheet: Trenchless Sewer Rehabilitation*. EPA 832-F-99-032.

National Association of Sewer Service Companies (NASSCO). 1996. *Manual of Practices - Wastewater Collection Systems*. 2nd ed. Baltimore, MD: NASSCO.

Institute for Research in Construction, National Research Council Canada. 2002. *Construction and Rehabilitation Costs for Buried Pipe with a Focus on Trenchless Technologies*. Prepared by Jack Q. Zhao and Balvant Rajani. Research Report No. 101.

Paulson, R. I., *et al.* 1984. "Attacking Private Infiltration/Inflow Sources." *Public Works*. 115 (2):54-59

Roberts, G. C. 1979. "Expediting Sewer Studies." *Water Sewer Work*. 126 (No. 2): 52.

Rowe, R., *et al.* 1995. *Data Handling Procedures Expedite Sewer Evaluation and Repair of Service Laterals*. Proceedings of the National Conference on Sanitary Sewer Overflows, Washington, DC, April 1995.

Water Environment Federation (WEF). 1999. *Control of Infiltration and Inflow in Private Building Sewer Connections*. Alexandria, VA: WEF.

Inclusion of this technology description in this Report to Congress does not imply endorsement of this technology by EPA and does not suggest that this technology is appropriate in all situations. Use of this technology does not guarantee regulatory compliance. The technology description is solely informational in intent.

Broken manhole (Limno-Tech, Inc.).

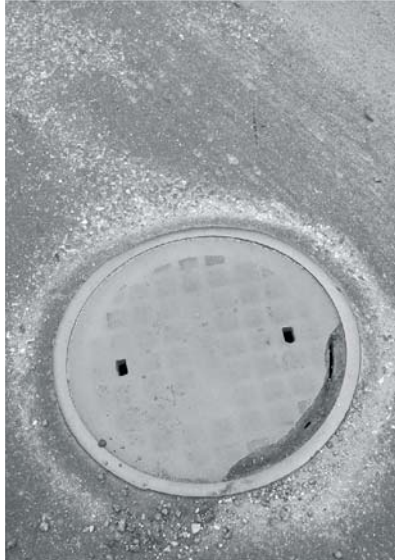

Manhole Rehabilitation

Overview

Manhole rehabilitation is one of several sewer system controls that can be implemented as part of an on-going maintenance or sewer rehabilitation program. Structurally defective manholes can be a source of significant infiltration and inflow (I/I) to a sewer system. Manhole rehabilitation is one way to reduce or eliminate I/I and preserve sewer system capacity for transporting wastewater. Manhole rehabilitation can range from spot repairs of structural components to complete manhole replacement. A typical manhole and its components are presented in Figure 1. Descriptions of manhole components and a summary of common defects are presented in Table 1.

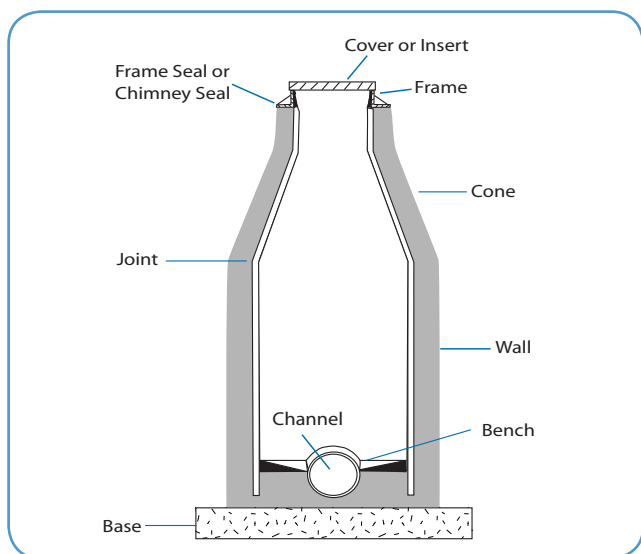

Figure 1. Schematic of a typical manhole

The most common manhole rehabilitation methods are: chemical grouting, spot repairs, coating systems, and structural reconstruction (ASCE 1997; NASSCO 1996). These methods are described in more detail below.

Chemical Grouting

Chemical grouting applications are used to fill and repair cracks and openings in manhole components,

primarily in the frame, chimney, and cone. There are a variety of grouts available including acrylamide, acrylate, acrylic, urethane gel, and urethane foam. The selection of a grout type should be based on site-specific considerations. A single grout or a combination of grout types may be used depending on the manhole's depth. The ideal ambient temperature for applying grout is about 40°F. Grouts need to be chemically stable; be resistant to acids, alkalis, and organics; have controlled reaction times; and have a 15 percent shrinkage control (ASCE 1997). For projects using a combination of grout types, urethane foam is typically used in the upper five feet of the manhole, while urethane gel or acrylamide are used for the lower section (ASCE 1997). Careful inspection of the grouting work and dye testing is recommended to ensure adequate sealing. The effectiveness of this method depends on soil conditions, groundwater table elevation, type of grouting mixture applied, pattern of injection, experience of the grout crew, and project quality control (ASCE 1997).

Spot Repair

Spot repairs include a variety of activities intended to restore damaged manhole components to a proper functional condition that prevents or minimizes I/I. Spot repairs may include: restoration or overhaul of specific components, or patch work depending on the degree of damage and the availability of replacement parts. The types of manhole I/I that can be addressed with spot repairs include surface water entering through holes in the manhole cover and the space between the manhole cover and frame, and subsurface water entering from under the manhole frame and chimney. Damaged manhole covers can be sealed by replacing them with a new watertight cover; sealing the existing cover with asphaltic mastic and plugging vent and pick hole plugs; installing watertight inserts under the existing manhole cover; or by installing rubber gaskets. Damaged frame-chimney joint areas can be sealed internally, without excavation, when frame alignment and chimney conditions permit.

Table 1. Summary of manhole components and common defects¹.

Component	Description	Typical Defects	Defect Result
Bench	Concrete or brick floor which directs incoming flows to the outlet piping and minimizes solids buildup. Includes bench/channel joint.	Cracked, loose, missing pieces, leaking channel/bench seal, deteriorated, or debris/deposition	Infiltration
Chimney	Narrow vertical section built from brick or from concrete adjusting rings that extends from the top of the cone to the frame and cover.	Cracked, broken, or deteriorated	Infiltration
Cone	Reducing section which tapers concentrically or eccentrically from the top wall joint to the chimney or the frame and cover.	Cracked, loose, missing mortar, leaking cone/wall joint, or deteriorated	Infiltration
Cover	Lid which provides access to the interior of the manhole.	Open vent or pick holes subject to ponding, bearing surface worn or deteriorated, poor fitting, cracked or broken, or missing	Inflow
Frame	The cast or ductile ring which supports the cover.	Bearing surface worn or deteriorated, no gasket for gasketed frames, cracked or broken, or frame offset from chimney	Infiltration and Inflow

¹ ASCE 1997

Coating Systems

Coating systems have been used successfully for manhole rehabilitation for over 20 years. The application of coating systems to the inner surface of the manhole protects concrete, steel, masonry, and fiberglass structures against chemical attack, abrasion, high temperatures, infiltration, and erosion. There are numerous coating systems available under various trade names, but in general they have similar basic components: rapid set patching, plugging, and coating compounds. The coating is applied in one or more layers to the manhole interior either by machine (spraying) or by hand. Surfaces that need coating require proper cleaning and preparation. If there is a potential for the presence of hydrogen sulfide, corrosion-resistant additives should be included in the coating mixture. Careful monitoring of cleaning, preparation, coating, and clean-up is important, as is testing for effectiveness after rehabilitation, using dye-water flooding, water exfiltration, or vacuum air testing.

Structural Reconstruction

Structural reconstruction is a rehabilitation method that completely restores the structural integrity of manhole walls through in-situ reconstruction methods. Structural reconstruction can be done with the following: poured-in-place concrete; prefabricated fiberglass, PVC rib-lock liner, prefabricated reinforced plastic mortar, spiral wound liner, cured-in-

place structural liners, prefabricated high-density polyethylene, and spray-applied systems (NASSCO 1996). Selection criteria for using this rehabilitation method include substantial structural degradation and life-cycle cost justifications. When completed, the wall should be a minimum of 36 inches in diameter and three inches thick. The use of Type II Portland cement mix and calcium aluminate or other special cement mixes or linings for corrosion resistance is generally recommended (ASCE 1997).

Key Considerations

The first step in selecting an appropriate manhole rehabilitation method is to conduct a thorough inspection of the manhole and its components. Selection of the appropriate method depends on several factors including:

- The type of problem to be remediated;
- Physical characteristics of the structure such as construction material, age, and condition of manhole;; and
- Location with respect to traffic and accessibility, risk of damage or injury associated with current condition, and cost/value in terms of rehabilitation performance (NASSCO 1996).

Applicability

Selection of an appropriate manhole rehabilitation technique is based on site-specific conditions. Chemical grouts are commonly used for rehabilitating manholes made of brick that are structurally sound. Spot repairs of manhole components are most appropriate for addressing minor defects. Coating systems are applicable for manholes with brick structures that show minimal or no evidence of movement or subsidence, since the coatings have minimal shear or tensile strength, and at sites not conducive to excavation or major reconstruction. Structural reconstruction is applicable for standard manhole dimensions (48-72 inches inner diameter) where substantial structural degradation has occurred. Structural reconstruction methods tend to be more expensive than other rehabilitation techniques.

Advantages

The primary advantage of manhole rehabilitation is a reduction in the capacity demanding I/I entering the sewer system through damaged manholes. Many municipalities have successfully implemented manhole rehabilitation programs as part of larger efforts aimed at reducing I/I and other extraneous flows into sewer systems. For manholes experiencing inflow from the surface, repairing or replacing individual components can be the most efficient and cost-effective rehabilitation method. For example, rubber gaskets are inexpensive and can effectively seal the cover without costly excavation. On a similar note, chemical grouting which seals cracks and voids along the manhole walls, is significantly less expensive than applying a coating system. Structural relining is often the most appropriate rehabilitation method for severely deteriorated manholes. An added benefit of structural relining is the renewal of manhole structural integrity and extended service life of the entire manhole.

Disadvantages

Manhole rehabilitation methods that require excavation can be significantly more expensive. For example, replacement of a manhole frame, rebuilding of a chimney and cone, and structural relining all require more extensive construction procedures including pavement replacement and surface restoration. Structural relining can reduce the diameter of the manhole and may entail higher initial costs. On the other hand, spot repairs or chemical grouting do not improve the structural integrity, and in some cases, may not be the most cost-effective long-term solution, especially for older manholes. In addition, the location of the manhole can entail significant safety risks for the work crew as some manholes are located in busy intersections and subject to considerable vehicle traffic.

Cost

The cost of rehabilitating individual manholes varies depending on the method selected and other site-specific conditions. A range of average costs for specific methods along with the anticipated useful life of the rehabilitated manhole or component are presented in Table 2. Selection of the most appropriate rehabilitation method often involves an assessment of cost and cost-effectiveness. If the amount of I/I controlled through manhole rehabilitation is known, then the cost of manhole rehabilitation can be compared directly with the cost of transporting and treating the I/I. When assessed in this manner, replacing or sealing of manhole covers is often cost-effective if substantial I/I enters the sewer system at manhole covers. However, in some situations, it may be more cost-effective to conduct a system-wide, comprehensive rehabilitation instead of assessing the need for repair or replacement of individual components. In addition to the volume of I/I removed, other important considerations include life-cycle cost, risk of failure, damage to surface from unrepaired manholes, disruption during construction, and life expectancy.

Table 2. Manhole rehabilitation costs and life expectancies.^a

Rehabilitation Method	Initial Cost Range (\$) ^b	Anticipated Life (Years)
Seal existing cover	20-50	8
Replace cover	120-240	50
Adjust frame		
with excavation	150-640	50
without excavation	150-200	25
Seal frame/applied seal	250-350	7
gasket (applied seal)	250-415	7
manufactured seal	250-415	25
Replace frame	415-685	50
Coating systems		
with corrosion protection	500-850	15
without corrosion protection	350-650	15
Chemical grouting	540-835	15
Structural lining	1,600-3,500	50
Replace manhole	2,400-5,500	50

^a Based on a standard 9-foot, 48-inch diameter manhole (ASCE 1997)

^b Costs are in 2002 dollars

Implementation Examples

PERKASIE BOROUGH, PA

Manhole Sealing

Responsible Agency: Perkasio Borough Authority

Population Served: 10,000

Service Area: 2.5 sq. mi.

Sewer System: 33.5 mi. of sanitary sewer

The Perkasio Borough Authority provides water and sewer services to Perkasio Borough and three neighboring communities in southeastern Pennsylvania. It is also one of six municipal members who have their sewage treated at a regional sewage treatment plant. In the early 1990s, the regional plant rated at 4 MGD was receiving 6-7 MGD of flow during wet weather. Concerned about the I/I, the Pennsylvania Department of Environmental Protection (DEP) implemented a moratorium on new sewer connections until I/I was substantially reduced.

Perkasio Borough found that manhole rehabilitation provided a simple, economical, and acceptable means to reduce I/I and get the moratorium on development lifted.

Perkasio Borough conducted a comprehensive study to determine the extent to which I/I contributed to high flow rates. As part of the study, flow monitoring was carried out at eight representative locations over a three month period which included extended dry periods, small to medium storm events, and three storms greater than one inch. The extent of I/I was determined through comparison of water use data with monitored flow data. Sewersheds were ranked from best to worst and prioritized for corrective action. A second flow monitoring effort was undertaken to determine the amount of I/I attributable specifically to manholes. Flow was measured in a sewershed serving 230 homes that had relatively new PVC piping. The flow monitoring showed that most of the inflow was entering the sewer system through manhole covers, frames, and connecting seals. Further, pilot tests showed that the installation of new seals would produce dramatic reductions in I/I. The evidence was so persuasive that the Pennsylvania DEP agreed that for every 3.2 seals installed, one new dwelling unit could be constructed in the service area. Perkasio Borough handles its own installations, and has found that the average cost-per-manhole is \$310 for components and installation. Installation of the seal is an economical and effective way to reduce I/I and has become a standard procedure for new manholes.

Contact Gary Winton, Perkasio Borough Authority

BROWARD COUNTY, FL

Manhole Rehabilitation

Responsible Agency: Broward County Southern Regional Sewer Authority

Population Served: 288,600

Service Area: 106 sq. mi.

Sewer System: 536 mi. of collection sewer

The Broward County Southern Regional Sewer Authority completed a comprehensive sewer system rehabilitation program in 1996. The rehabilitation program eliminated approximately 5.64 MGD of extraneous flow via 429 manholes repairs, 427

sewer line point repairs covering approximately 179,360 linear feet of lined or grouted main sewer line, and 314 private service lateral repairs. The sewer rehabilitation program reached its goal of eliminating 35 percent of the total system I/I. The construction cost for this project was \$6.9 million.

Manhole Rehabilitation Method	Number Completed
Cementitious liner	333
Realign manhole cover	59
Install cover inserts	58
Replace frame and cover	32
Install fiberglass liner	10

More information at <http://www.avantigrout.com/literature/casestudymiamil.pdf>

CINCINNATI, OH

Responsible Agency: Metropolitan Sewer District of Greater Cincinnati

Population Served: 800,000

Service Area: 400 sq. mi.

Sewer System: Over 3,000 mi. of sanitary and combined sewer

Manhole Rehabilitation Project

The Metropolitan Sewer District of Greater Cincinnati (MSD-GC) provides wastewater treatment services to more than 800,000 customers in Hamilton County, Ohio. Faced with I/I problems, MSD-GC conducted a demonstration project to evaluate various manhole rehabilitation products as part of a larger sewer system rehabilitation program. In 2001, over 35 different manhole rehabilitation products were installed and tested. The knowledge gained from the demonstration project allowed MSD-GC to develop specifications to maximize the success of future manhole rehabilitation efforts. These specifications involved the

development of guidelines on substrate preparation, material application, frost-line protection, testing and inspection, and contract warranty requirements. Manholes requiring rehabilitation of the invert (flow channel) were found to be more costly due to the need to plug and bypass flows.

Following the demonstration project, MSD-GC launched a project to evaluate the performance and cost of three particular manhole rehabilitation methods (i.e., cementitious coatings, spray-on epoxy coatings, and cured-in-place manhole liners). This project will result in the rehabilitation of 150-300 brick and concrete manholes per year, at an annual cost of approximately \$1 million. This project also allows MSD-GC to test the effectiveness of its current manhole rehabilitation specifications and to make necessary adjustments based on performance results. Initial post-rehabilitation flow monitoring data indicate improvement as a result of the manhole rehabilitation. The data show that cementitious coatings and spray-on epoxy are less effective than cured-in-place methods in reducing I/I.

Contact Ralph Johnstone, Metropolitan Sewer District of Greater Cincinnati

References

American Society of Civil Engineers (ASCE). 1997. *Manhole Inspection and Rehabilitation*. In *Manuals and Reports on Engineering Practice No. 92*. Prepared by the Committee on Manhole Rehabilitation of the Pipeline Division of the ASCE. New York, NY: ASCE.

EPA Office of Research and Development, Center for Environmental Research Information. 1991. *Handbook: Sewer System Infrastructure Analysis and Rehabilitation*. Cincinnati, OH: EPA Office of Research and Development. EPA/625/6-91/030.

Johnstone, Ralph. Interview by Limno-Tech, Inc., December 2002. Washington, D.C.

Larson, J.P., and C. Garcia-Marquez. 2000. *Broward County, Florida – Successful I/I Rehabilitation Programs*. Presented at the Water Environment Federation WEFTEC Conference, Anaheim, CA, 2000.

National Association of Sewer Service Companies (NASSCO). 1996. *Manual of Practices: Wastewater Collection Systems*. 2nd ed. Maitland, FL: NASSCO.

Metropolitan Sewer District of Greater Cincinnati (MSD-GC). "MSD Receives Trenchless Technology Award." Retrieved December 9, 2002. http://www.msdcg.org/news/archives/trenchless_tech_award/

Winton, Gary. Interview by Limno-Tech, Inc., March 2003. Washington, D.C.

Inclusion of this technology description in this Report to Congress does not imply endorsement of this technology by EPA and does not suggest that this technology is appropriate in all situations. Use of this technology does not guarantee regulatory compliance. The technology description is solely informational in intent.



In-Line Storage

Overview

Many sewer systems experience high flow rates during wet weather periods. The use of storage facilities to attenuate and store peak wet weather flows is widely implemented to reduce or eliminate CSOs and SSOs. In-line or in-system storage is the term used to describe facilities that depend on existing, available storage in the sewer system to control wet weather flows. In-line storage techniques include the use of flow regulators, in-line tanks or basins, and parallel relief sewers. Each of these types of in-line storage is described below.

Flow Regulators

Flow regulators are used to optimize in-line storage by damming or limiting flow in specific areas of the sewer system. Flow regulators can be grouped into two categories: fixed and adjustable.

Fixed regulators, as their name implies, are stationary and do not adjust to variations in flow. They are ideally located at key hydraulic control points. With fewer moving parts and sensors, fixed regulators tend to be less expensive to install, operate, and maintain than adjustable regulators. Fixed regulators include:

- Orifices
- Weirs
- Flow throttle valves
- Restricted outlets
- Vortex throttle valves

One specific type of fixed regulator is the vortex throttle valve shown in Figure 1. Low flows pass through vortex throttle valves without restriction. Once the flow reaches a pre-determined level, an air-filled vortex is automatically created that reduces the area through which flow can pass, damming the flow behind the valve (John Meunier/USFilter 2002). The vortex does not create a constriction. Trash and debris flow

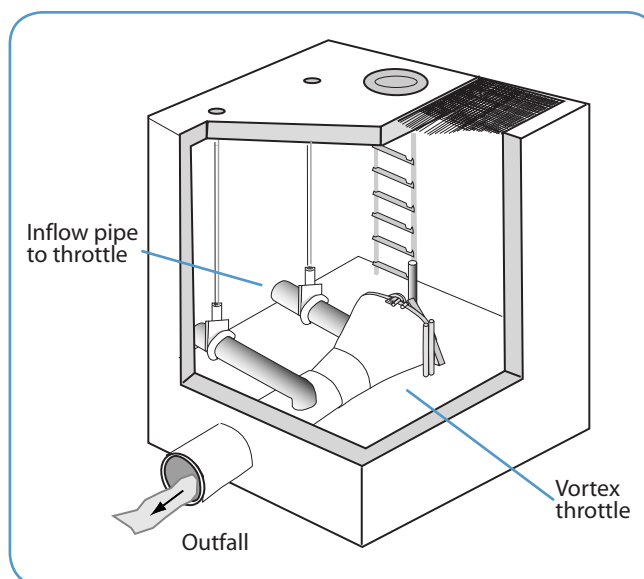

Figure 1. Schematic of a vortex throttle.

through the valve easily after excess flows subside (EPA 1993).

Adjustable regulators are more complex and can be operated in a dynamic mode. Consequently, they offer a greater potential to maximize the available in-system storage by reacting to the variable nature of flow in the sewer system (Moffa 1997). Adjustable regulators include:

- Inflatable dams
- Reverse-tainter gates
- Float-controlled gates
- Sluice-type gates
- Tilting plate regulators

An example of an adjustable regulator is the inflatable dam, shown in Figure 2. Inflatable dams are typically made of rubberized fabric and are inflated and deflated to control flow. Automatic sensors are often used to activate the dams. The dams can be filled with air,

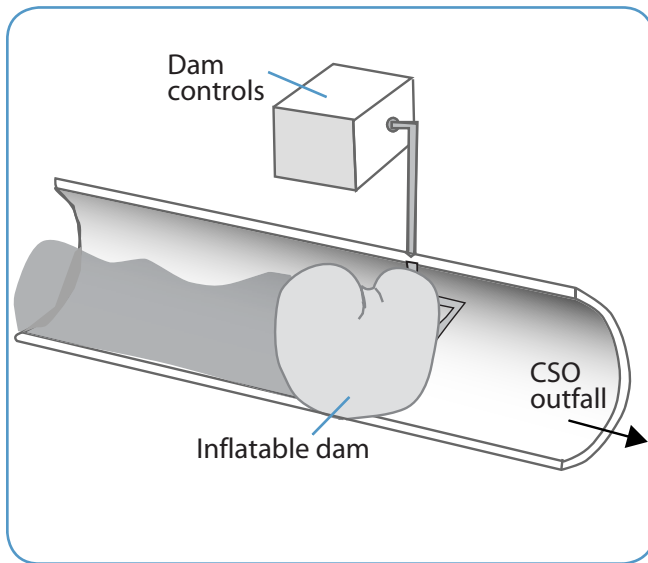

Figure 2. Schematic of an inflatable dam system.

water, or a combination of both. Air control is generally less costly, but water provides better control over dam shape (EPA 1993). With the dam inflated, flow can be stored in upstream pipes.

In-Line Storage Tanks or Basins

Storage tanks and basins constructed in-line within the sewer system can also be used to attenuate and store flows during wet weather periods. Dry weather flows pass directly through in-line storage tanks or basins. Storage within the in-line tanks or basins is typically governed by a flow regulator which limits flow exiting the facility during wet weather periods. The primary function of in-line storage structures is the attenuation of peak flows, not treatment. Flows exiting the storage structure are conveyed downstream for treatment. Therefore, unlike off-line retention basins and deep tunnel storage facilities, in-line tanks and basins are rarely equipped with disinfection, and may not have an outlet to discharge directly to a receiving water.

Parallel Relief Sewers

In-line capacity can also be created by installing relief sewers parallel to existing sewers, or by replacing older sewers with larger diameter pipes. The installation of parallel relief sewers, or larger pipes, is accomplished in the same manner as installing new pipes – using traditional open-cut construction methods or trenchless technologies. Trenchless technologies refer to several types of construction methods that minimize the environmental and surface impacts of sewer installation. More information on these techniques is provided in the “Sewer Rehabilitation Technology Description,” in Appendix B of the 2003 *Report to Congress on the Impacts and Control of CSOs and SSOs*.

Key Considerations

Applicability

Taking advantage of existing storage within the sewer system has broad application in CSSs and SSSs. It is regarded as a cost-effective way to reduce the frequency and volume of CSOs and SSOs, often without large capital investments. Maximization of storage in the sewer system is one of the NMC required of all CSO communities. EPA guidance describes maximization of storage as “making relatively simple modifications to the CSS to enable the system itself to store wet weather flow until downstream sewers and treatment facilities can handle them” (EPA 1995).

The physical condition of the sewer system must be considered when examining potential in-line storage. The amount of storage potentially available in the sewer system largely depends on the size or capacity of the pipes that will be used for storage, and the suitability of sites for installing regulating devices. The trunk sewers and many interceptors within CSSs are often designed to convey flows 5-10 times greater than average dry weather flows, and often provide some potential capacity for storage. Also, areas where the pipe slope is relatively flat often offer opportunities for storage.

An important component of successful in-line storage applications is proper operation and maintenance. By maintaining the initial condition of the sewer system (i.e., not allowing sediment build up within the pipes), the complete capacity of the sewer is available for storing and transporting excess wet weather flows. Similarly, CSO and SSO volumes can be reduced by removing obstructions that decrease the capacity of the sewer system. Larger objects often must be removed by hand, whereas sewer flushing can be used to remove smaller obstructions and sediment build up (EPA 1999). Additional sewer cleaning techniques are discussed in the “Sewer Cleaning Technology Description,” in Appendix B of the 2003 *Report to Congress on the Impacts and Controls of CSOs and SSOs*.

Certain factors limit the applicability of in-line storage; for example it can increase the possibility of basement backups and street flooding (EPA 1999). Basement backups occur when the level of the flow in the sewer is higher than the level of the connection between the service lateral and the building basement. Storing flow in existing pipes may exacerbate this condition because damming devices raise the level of the flow in the sewer system. Field surveys and investigations of sewer maps and as-built drawings are required in order to prevent the throttling back of flows to a degree that causes flooding and backups.

Use of in-line storage may also slow flows and allow sediment and other debris present in wastewater or urban runoff to settle out in the pipes. If allowed to accumulate, the sediment and debris can reduce available storage and conveyance capacity. Therefore, an important design consideration for in-system storage is to ensure that minimum flow velocities are provided to flush and transport solids to the wastewater treatment plant.

Advantages

Advantages of in-line storage include:

- Maximum utilization of existing capacity, which may reduce size or scope of other controls;
- Development of in-line storage in parallel relief or upsized sewers can be coupled with other sewer rehabilitation projects;
- Relatively inexpensive in comparison to other types of storage;
- Attenuates peak wet weather flows and equalizes loads to the treatment facility; and
- Reduces frequency and volume of CSOs and SSOs during light to moderate rainfall events.

Disadvantages

Disadvantages of in-line storage include:

- Provides little treatment of wet weather flows on its own;
- May be difficult to construct large storage volumes typically required for complete CSO control; and
- Increased potential for basement backups and street flooding.

Cost

The largest expenditure for most types of storage facilities is the construction of the actual storage volume. By taking advantage of underutilized capacity that may currently exist within the sewer system, costs are limited to flow regulators and other equipment needed to optimize the attenuation and storage of wet weather flows. The costs associated with construction of in-line storage range from approximately \$0.06 per gallon to more than \$1 per gallon. Cost information from a number of in-line storage applications is presented in Table 1 and 2.

The cost information shows that per gallon costs of storage developed using flow regulators are significantly less than storage developed through the installation of large diameter or parallel relief sewers.

Table 1. Summary of costs of inflatable dam installed in select communities.

Municipality	Technology	Characteristics	Year Constructed	Cost
Washington, DC	Inflatable Dam	<ul style="list-style-type: none"> • Total Storage = 36 MG • 2 dams in 8 locations throughout the system • Fully inflated under low pressure during dry weather 	1990	Construction Cost: \$2.2 million or \$0.06/gallon
Louisville, KY	Inflatable Dam	<ul style="list-style-type: none"> • Total Storage = 2.5 MG • Sneads Branch Relief Sewer collects wet weather flow from 11 CSOs 	2001	Construction Cost: \$1.07 million or \$0.43/gallon
Saginaw, MI	Flow Control Chamber with a Vortex Throttle	<ul style="list-style-type: none"> • Total Storage = 1.4 MG 	1986	Construction Cost: Less than \$290,000 or \$0.21/gallon
Philadelphia, PA	Inflatable Dam	<ul style="list-style-type: none"> • Total Storage = 16.3 MG • 3 large inflatable dams located in large sewers 11-15 ft. high • Can inflate in 15 minutes and deflate in 5 minutes 	Planned	Dam Cost: \$650,000 Civil Construction Cost: \$4.2 million Total Cost: \$4.8 million or \$0.29/gallon
Houston, TX	Parallel Relief Sewer	<ul style="list-style-type: none"> • Total Storage = ~ 0.64 MG • Diameter: 36 in., 18 in., and 15 in. • Length: over 6,000 ft. • Installed parallel to the existing system which was abandoned in place • Part of a plan to eliminate overflows from sewer system 	1995	Construction Cost: \$436,126 or \$0.68/gallon

Table 2. Summary of costs of in-line basins and relief sewers in communities.

Municipality	Technology	Characteristics	Year Constructed	Cost
Bangor, ME	In-line Basin	<ul style="list-style-type: none"> In-line storage tunnel Made from V-bottom precast box sections 		
		<p><i>Davis Brooke Storage Facility</i> Total Storage = 1.2 MG</p> <p><i>Barkersville Storage Facility</i> Total Storage = 1.4 MG</p>	1998	Construction Cost: \$1.4 million or \$1.17/gallon
			2002	Construction Cost: \$2 million or \$1.43/gallon
Houston, TX	Parallel Relief Sewer	<ul style="list-style-type: none"> Total Storage = ~ 0.64 MG Diameter: 36 in., 18 in., and 15 in. Length: over 6,000 ft. Installed parallel to the existing system which was abandoned in place Part of a plan to eliminate overflows from sewer system 	1995	Construction Cost: \$436,126 or \$0.68/gallon
Portland, OR	Parallel Relief Sewer	<ul style="list-style-type: none"> Total Storage = ~ 42 MG Conveyance pipe that is 6 ft. in diameter and a storage pipe that is 12 ft. in diameter Total length is 3.5 mi. 	2000	Design and Construction Cost: \$76 million or \$1.81/gallon
Syracuse, NY	In-line Basin	<ul style="list-style-type: none"> Total Storage = 5 MG Erie Boulevard Storage Facility Box culvert with sluice gate control Dimensions: 7.5 ft. wide, 10.5 ft. high, and 8,640 ft. long 	1970s; refurbished 2002	Approximate Cost of Refurbishment: \$2.6 million or \$0.53/gallon

Implementation Examples

BOSTON, MA

System Optimization Plan

Responsible Agency: Massachusetts Water Resources Authority

Population Served: 2.5 million

Service Area: 406 sq. mi.; 13 sq. mi. of combined sewers

Sewer System: 228 mi. of interceptor sewer

The Massachusetts Water Resources Authority (MWRA) provides sewer services for 43 communities in the Boston metropolitan area. The City of Boston and three surrounding communities have combined sewer areas. MWRA developed a system optimization plan in 1993, which included operational modifications and simple, low-cost structural changes to reduce CSO frequency. Structural alterations included repairing regulators, raising weir heights, and installing new weirs and regulators to increase storage within the sewer system. All 103 projects outlined in the system optimization plan have been completed. MWRA has since completed other system evaluations that have resulted in more simple structural alterations to reduce the occurrence of CSOs. As of 1997, MWRA had spent a total of \$3.1 million on structural alterations, which have reduced average annual CSO discharges by 400 MG. The typical capital costs for brick and mortar weirs, formed concrete weirs, and stop logs are \$3,650, \$13,525, and \$20,315, respectively.

More information at <http://www.mwra.state.ma.us/sewer/html/sewco.htm>

LOUISVILLE, KY

Responsible Agency: Louisville and Jefferson County Metropolitan Sewer District

Population Served: 600,000

Service Area: 205 sq. mi.

Sewer System: ~ 2,800 mi. of sewers

Snead Branch Relief Sewer Inflatable Dam

The Sneads Branch Relief Sewer is an 11 foot semi-elliptical tunnel that was built in 1951 to control flooding. The relief sewer receives no dry weather flow, which was one of the reasons it was selected for storage of wet weather events. An inflatable rubber dam was installed to maximize storage in the relief sewer; minimal tunnel modifications were necessary. During normal flow conditions, the dam is half inflated. During wet weather

events, it is inflated to full height. A water level sensor just above the dam activates the inflation. The relief sewer captures flow from 11 upstream CSOs, and it can store up to 2.5 MG of combined sewage. It is predicted that the inflatable dam will reduce the average annual CSO volume by 63 percent from 43 MG per year to 18 MG per year. The cost of the Sneads Branch Relief Sewer Inflatable Dam was \$1.07 million or \$0.43/gallon of storage.

Contact: Angela Akridge, Louisville and Jefferson Metropolitan Sewer District

PHILADELPHIA, PA

Responsible Agency: Philadelphia Water Department

Population Served: 2 million

Service Area: 335 sq. mi.

Sewer System: 1,600 mi. of combined sewers

Inflatable Dams

As part of Philadelphia's effort to control CSOs, the City Water Department plans to install three inflatable dams in large sewers that have available in-line storage. The dams will range from 11 to 15 feet high and will be automatically controlled for both dry and wet weather conditions. The three dams will enable 16.3 MG of flow that might otherwise discharge to local receiving waters to be stored in existing sewers, reducing CSO volumes by 650 MG per year.

The first inflatable dam, located in the city's main relief sewer, will be operational by the end of 2004. The associated civil work projects such as sewer rehabilitation have been completed for this project. When operating, the dam will have the ability to store up to 4 MG of combined sewage, and it is expected to reduce the number of CSO discharges to the Schuylkill River from 32 per year to four per year. Another inflatable dam will be installed in Rock Run during the summer of 2005. The total cost for the installation of the dams and sewer rehabilitation is approximately \$4.8 million, or \$0.29/gallon of storage.

More information at http://www.forester.net/sw_0011_innovative.html and <http://www.phila.gov/water/index.html>

SYRACUSE, NY

Erie Boulevard Storage System

Responsible Agency: Onondaga County
Department of Water Environment
Protection

Population Served: 400,000

Service Area: 13 sq. mi.; 11 sq. mi. of
combined sewer

Sewer System: 3,000 mi. of sewer

The Erie Boulevard Storage System was originally constructed in the 1970s as a separate storm water system. The facility is a box culvert that is 7.5 feet by 10.5 feet and 8,640 feet long. It has a storage volume of 5 MG, and an additional 1 MG of storage is available in ancillary conveyance pipes. It was retrofitted in 1985 with four sluice gates to facilitate the storage of combined sewage, and reduce CSO discharges to Onondaga Creek.

The original sluice gate control system was located within underground concrete vaults. Moisture and road salt severely damaged the control system requiring a facility upgrade. The upgrade was completed in July 2002, and included refurbishment of the sluice gates, construction of an above ground control center, and installation of a real-time control system. It is estimated that the Erie Boulevard Storage System will now capture 220 MG of wet weather flow annually. Upgrades to the Erie Boulevard Storage System cost \$2.6 million or \$0.52/gallon of storage.

More information at <http://www.lake.onondaga.ny.us/ol3113.htm>

PORTLAND, OR

Parallel Relief Sewers

Responsible Agency: City of Portland

Population Served: 500,000

Service Area: 133 sq. mi.

Sewer System: 2,256 mi. of sewer

In 1972, the City of Portland's CSS was estimated to release 10 BG of CSO annually into local receiving waters. In 1991, the city started a 20-year program to curb CSOs to the Willamette River by 94 percent, and to the Columbia Slough by over 99 percent. The plan includes actions to fully utilize storage in the existing sewer system by modifying 32 diversion structures.

The city has also invested in the construction of parallel relief sewers to store combined sewage that would otherwise be discharged to the Columbia Slough. Specifically, the city constructed 3.5 miles of six foot diameter conveyance pipe and a 12 foot diameter parallel relief sewer. It took three years to construct this relief sewer, which became operational in September 2000. It captures 100 percent of the overflows from the eight CSO outfalls in its drainage area and an average of 440 MG of combined sewage per year. The cost of the Columbia Slough Consolidation Conduit was approximately \$76 million or \$1.81/gallon of storage.

More information at <http://www.cleanriverworks.com/>

References

City of Portland, Oregon, Bureau of Environmental Services. 2002. "Action 4: Upgrading Portland's Eastside Sewer System." Retrieved October 2, 2002. <http://www.cleanrivers-pdx.org/pdf/action4.pdf>

Dahme, J. and J. Sullen. 2000. "Innovative Strategy Helps Philadelphia Manage Combined Sewer Overflows." Retrieved October 7, 2002. http://www.forester.net/sw_0011_innovative.html

District of Columbia Water and Sewer Authority. 2002. "Final Report: Combined Sewer System Long Term Control Plan." Retrieved October 9, 2002. <http://www.dcwasa.com/education/css/longtermcontrolplan.cfm>

EPA Office of Research and Development. 1993. *Manual: Combined Sewer Overflow Control*. EPA 625-R-93-007.

EPA Office of Water. 1995. CSO Guidance for Nine Minimum Controls. EPA-832-B-95-003.

EPA Office of Water. 1999. *Combined Sewer Overflow Technology Fact Sheet: Maximization of In-line Storage*. EPA 832-F-99-036.

Gray, W. et al. 1999. *Prevention and Control of Sewer System Overflows: WEF Manual of Practice No. FD-17*. Alexandria: Water Environment Federation.

John Meunier/USFilter. 2002. "CSO/Stormwater Management: Hydrovex Product Line." Retrieved December 9, 2002. http://www.johnmeunier.com/2002/en/products/pdf/hydrovex_line_card.pdf

Moffa, Peter. 1997. *Control and Treatment of Combined Sewer Overflows*. New York: Van Nostrand Reinhold.

Inclusion of this technology description in this Report to Congress does not imply endorsement of this technology by EPA and does not suggest that this technology is appropriate in all situations. Use of this technology does not guarantee regulatory compliance. The technology description is solely informational in intent.



TECHNOLOGY DESCRIPTION

STORAGE FACILITIES

Off-Line Storage

Overview

Many sewer systems experience high flow rates during wet weather periods. The use of storage facilities to store and attenuate peak wet weather flows is widely implemented to reduce or eliminate CSOs and SSOs. Off-line storage is the term used to describe facilities that store or treat excess wet weather flows in tanks, basins, tunnels, or other structures located adjacent to the sewer system. During dry weather, wastewater is passed around, not through, off-line storage facilities. During wet weather, flows are diverted from the sewer system to these off-line storage facilities by gravity drainage or with pumps. The stored wastewater is temporarily detained in the storage facility and returned to the sewer system once downstream conveyance and treatment capacity become available. Most off-line storage structures provide some treatment through settling, but their primary function is storage and the attenuation of peak flows. The use of off-line storage is usually considered to be a good option where in-line storage is insufficient or unavailable.

Near-Surface Storage Facilities

Near-surface storage facilities are typically located at key hydraulic control points. In CSSs, they are often located near a CSO outfall; in SSSs, they are often situated in areas where inflow and infiltration (I/I) problems are severe and difficult to otherwise control. A typical near-surface storage facility is a closed concrete structure with a simple design that is built at or near grade alongside a major interceptor. As shown in Figure 1, the basic components of near-surface storage facilities are:

- Basin or tank
- Flow regulating device to divert wet weather flows to the basin or tank
- Flow regulating device or pumps to drain the basin or tank
- Emergency relief or overflow point

Near-surface storage facilities in CSSs are sometimes designed for both storage and treatment. When designed and operated for these purposes, they can provide primary treatment or its equivalent including primary clarification, capture of solids and floatables, and disinfection of effluent, where necessary, to meet water quality standards (EPA 1994). Consequently, screens and disinfection equipment are sometimes added to those near-surface storage facilities designed to discharge directly to receiving waters.

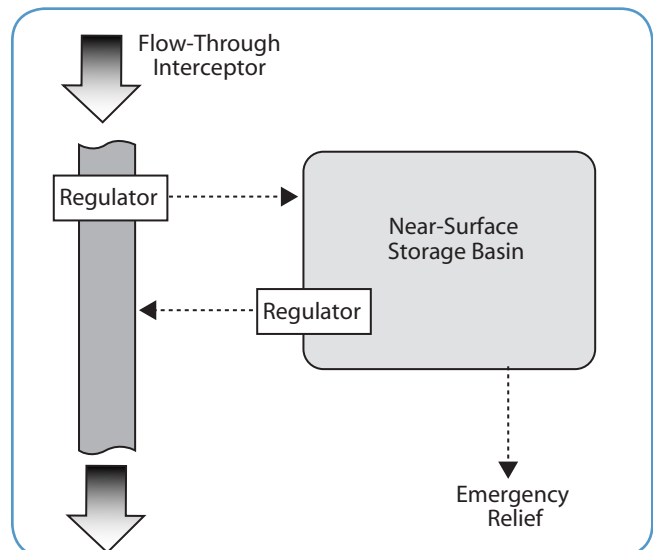

Figure 1. Basic components of near-surface storage facility.

An illustration of a more complex near-surface storage facility with multiple tanks that is designed to provide both storage and treatment is presented in Figure 2. As shown, screens are employed to remove floatables and coarse solids, and flows receive disinfection prior to discharge. Multiple tanks are used to enhance pollutant removal and facilitate maintenance activities. The benefits of using multiple tanks include:

- The “first flush” of pollutants can be retained in one or more of the tanks long enough to settle suspended solids, BOD, and nutrients, while the remainder of the flow is handled in subsequent compartments
- Allows portions of the facility to remain in service while maintenance is performed on other portions of the facility. The number of compartments used can vary from storm-to-storm according to the volume of excess wet weather flow generated, potentially reducing the area requiring maintenance after smaller storms, which in turn reduces costs

In a multiple tank configuration, excess wet weather flows can either pass through each compartment sequentially (i.e., the flow proceeds through chamber one, followed by chamber two, and then chamber three) or through each compartment simultaneously (i.e., there is flow in compartments one, two, and three at the same time). Both operational strategies are illustrated in Figure 2. However, near-surface storage facilities with multiple compartments are typically operated in a sequential manner. Specific advantages of sequential operation include:

- Tanks are only filled as the capacity of a preceding tank is exceeded; and
- Only that flow reaching the final tank is disinfected, saving on chemical costs.

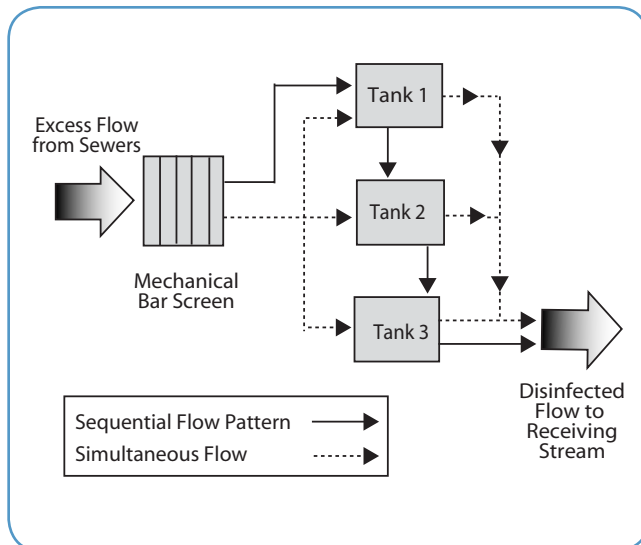

Figure 2. Flow paths for sequential and simultaneous storage facilities.

Deep Tunnels

Deep tunnel storage facilities are typically used where large storage volumes are required and opportunities

for near-surface storage are unavailable. Deep tunnels are primarily implemented as controls in CSSs, but have had some application in SSSs. As their name implies, deep tunnels are typically located 100-400 feet below ground. Tunnel diameters range from 10-50 feet, and many are several miles in length. Construction usually requires large tunnel boring machines. Most deep tunnels are built in hard rock, but some have been built in unconsolidated material. Lining the tunnel with concrete or other impermeable material to prevent infiltration and exfiltration is required in unconsolidated material, and is recommended for hard rock. Like near-surface storage facilities, stored flow is typically conveyed from deep tunnels to a wastewater treatment plant (WWTP) after wet weather events, as capacity becomes available.

An illustration of a deep tunnel, as constructed in Milwaukee, WI, is presented in Figure 3. The basic components of deep tunnels include:

- Storage tunnel;
- Flow regulating devices to divert wet weather flows to the tunnel;
- Coarse screening to protect tunnel facilities from large debris;
- Vertical drop shafts to convey wet weather flows to the tunnel;
- Pumps to drain and de-water the tunnel;
- Vent shafts to balance air pressure in the tunnel;
- Access shafts that give maintenance personnel access to the tunnel;
- Solids removal system for areas where grit may accumulate; and
- Odor control system, if necessary.

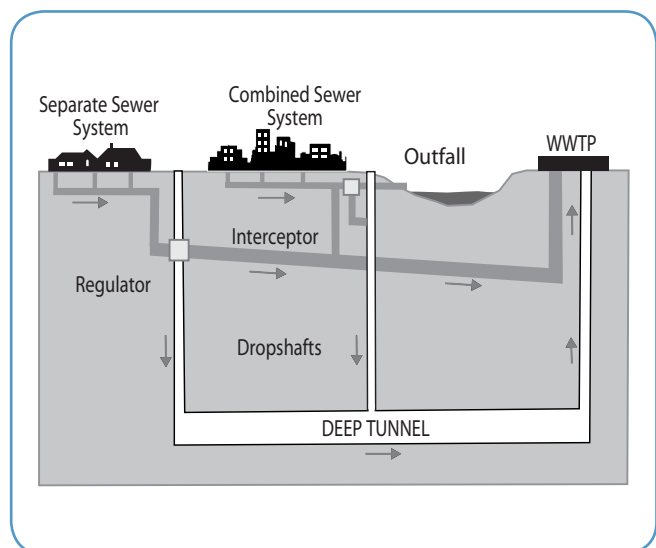

Figure 3. Deep tunnel storage (MMSD 2001).

Key Considerations

Applicability

Near-Surface Storage Facilities

Near-surface storage facilities have broad applicability and can be adapted to many different site-specific conditions by changing the basin size (volume), layout, proximity to the ground surface, inlet or outlet type, and, where required, disinfection mechanism. They are particularly applicable in areas where land is readily available and the disruption, due to construction, will be minimal. The adaptability of near-surface storage facilities has led to their use throughout the country. The flexibility of the basin design makes near-surface storage facilities practical for utilities, both large or small, in all climates.

Deep Tunnels

Deep tunnels provide an alternative to near-surface storage facilities where space constraints, potential construction impacts, and other issues make constructing near-surface facilities challenging. Deep tunnels can be constructed in a variety of mediums, but geotechnical exploration is needed to assess the suitability of subsurface conditions.

The major construction concerns are the structural integrity of the tunnel, infiltration of groundwater, and exfiltration of the stored flows. Tunneling in hard rock tends to be more economical because such tunnels need minimal, temporary, or permanent structural supports. Hard rock tunnels also require less lining to prevent infiltration and exfiltration (NBC 1998). When tunneling in soft rock or soil, the tunneling equipment is more expensive. Special equipment is needed to support the tunnel during construction to prevent the ground from collapsing. In addition, the cost of lining the tunnel can be greater because the lining is used to maintain the shape of the tunnel as well as to prevent infiltration.

Advantages

Near-Surface Storage Facilities

Advantages of near-surface storage facilities include:

- Structural design is simple compared to tunnels and supplemental treatment facilities;
- Construction and O&M costs are favorable relative to other structural approaches such as sewer separation (EPA 1999);
- Operation and response to intermittent and unpredictable wet weather events is automatic to a certain extent;

- Operators are allowed the flexibility of returning the stored wastewater flow to the treatment facility where it can receive full treatment; maximizing utilization of existing treatment facilities;
- Helps equalize the delivery of pollutants to the treatment plant, which tends to improve effluent quality at the treatment facility as well as treatment efficiency;
- Treatment of excess wet weather flows consistent with the CSO Control Policy can be achieved in CSSs; and
- Aesthetic benefits and other locally defined objectives can be realized with imaginative design. For example, Wayne County, MI, constructed two covered near-surface storage facilities that were landscaped with recreation facilities including soccer fields and basketball courts (Wayne County 2000).

Deep Tunnels

Advantages of deep tunnel storage include:

- Large volumes can be stored and transported while having a minimal effect on the existing surface features (EPA 1993);
- Disruptions that occur with the open-cut excavations associated with near-surface storage facilities can be avoided (EPA 1993); and
- Valuable surface land area is saved by building deep under the ground's surface.

Disadvantages

Near-Surface Storage Facilities

Disadvantages of near-surface storage facilities include:

- Costs can be substantial relative to non-structural controls such as I/I reduction;
- Land required for basins and tanks is often located in premium waterfront locations ;
- Construction activities are disruptive;
- On-going maintenance with attendant costs is required to keep facilities operating; and
- Solids and captured floatables must be removed and properly disposed to maintain storage capacity.

Deep Tunnels

Disadvantages of deep tunnel storage include:

- Difficult to map subsurface;
- Budget overruns can occur when boring does not proceed as planned;
- Tunnels may require substantial, on-going maintenance activities, including the disposal of built-up sediment deposits;

- Exfiltration from deep tunnels has the potential to adversely affect the quality of groundwater in adjacent aquifers; and
- Construction schedules for deep tunnels may be lengthy, allowing considerable time to pass between the initial investment and any measured water quality improvements.

Cost

The costs associated with construction of off-line storage facilities range from less than \$0.10 per gallon to \$4.61 per gallon. In general, costs for near-surface storage facilities were considerably less than those for deep tunnels. The average cost for deep tunnels was \$2.82 per gallon, while the average cost for near-surface storage was \$1.75 per gallon. Tables 1 and 2 present cost information for near-surface and deep tunnel storage facilities, respectively.

Table 1. Deep tunnel costs from select communities.

Municipality	Facility Name	Facility Characteristics	Year Initiated	Construction Cost ¹
Washington, DC		Total Storage = 194 MG 3 deep rock tunnels	To be constructed	\$761 million or \$3.92/gallon
Atlanta, GA	Intrenchment Creek	Total Storage = 34 MG 26 ft. diameter 9,293 ft. long	1985	\$42.2 million or \$1.24/gallon
Chicago, IL	TARP Project	Total Storage = 2.3 BG 109 mi. of deep rock tunnels 150-350 ft. below ground	1976 (Near completion)	\$2.51 billion or \$1.09/gallon
Rochester, NY		Total Storage = 175 MG	1993	\$690 million or \$3.94/gallon
Providence, RI		Total Storage = 56 MG 200-300 ft. below ground 26 ft. in diameter 13,500 ft long	2001 (Under construction)	\$258 million or \$4.61/gallon
Milwaukee, WI		Total Storage = 405 MG Depth up to 325 ft.	1994	\$866 million or \$2.13/gallon

¹ All costs are in 2002 dollars.

Table 2. Near-surface storage costs from select communities.

Municipality	Facility Name	Facility Characteristics	Year Initiated	Construction Cost ¹
Atlanta, GA	McDaniel CSO Facility	Underground basin Total Storage = 2 MG	1986	\$9.2 million or \$1.53/gallon
Chicago, IL	TARP Project	Three retention basins Total Storage = 15.7 BG	1976 (Under construction)	\$1.11 billion or \$0.07/gallon
Bangor, ME		Made from pre-cast concrete sections Total Storage = 1.2 MG	2000	\$2.5 million or \$2.08/gallon
Birmingham, MI		Two compartment retention basin Flow is simultaneous Total Storage = 5.5 MG	1997	\$14.4 million or \$2.61/gallon
Grand Rapids, MI	Market Avenue	Three compartment retention basin; flow is sequential Total Storage = 30.5 MG	1992	\$39 million or \$1.24/gallon
Fairport Harbor, OH	Retention Basin	Old oil tank converted for wet weather storage Total Storage = 3.2 MG	1994	\$3.1 million or \$0.97/gallon
Seattle, WA		Total Storage = 1.6 MG	1984	\$6.1 million or \$3.80/gallon
Richmond, VA	Shockoe Basin	Covered and uncovered retention basin Total Storage= 41 MG	~1988	\$70 million or \$1.73/gallon

¹ All costs are in 2002 dollars.

Implementation Examples

CHICAGO, IL

Responsible Agency: Metropolitan Water Reclamation District of Greater Chicago

Population Served: 5.1 million

Service Area: 873 sq. mi.

Sewer System: 4,300 total miles of sewer

Tunnel and Reservoir Plan (TARP)

Construction of Chicago's Tunnel and Reservoir Plan (TARP) began in 1976. The TARP contains both deep tunnels and a system of three large reservoirs that act as near-surface storage facilities. TARP has been implemented in two phases. The first phase focused on reducing CSOs. The second phase provides flood control benefits as well as further increases CSO capture. When completed, the TARP will have 18 BG of total storage between the three reservoirs and multiple deep tunnels. The three reservoirs hold 15.7 BG; the plan also includes 109 miles of deep rock tunnels, located 150-350 feet beneath the ground surface. One reservoir is

located on the site of an abandoned quarry. This siting reduces the amount of excavation needed for the reservoir, but does not eliminate it. The tunnels are lined to prevent infiltration and exfiltration. Pumping and treating the total volume stored in the TARP facilities will take two to three days. Since construction started, water quality in the Chicago area receiving waters has improved. Mass loadings of BOD₅, TSS, and volatile suspended solids have dropped by 13, 62, and 60 percent, respectively. Once the system is completed, tunnels in 2006 and reservoirs in 2014, it is believed that further water quality improvements will be observed. The total predicted cost of TARP is \$3.62 billion. The cost of the reservoirs is \$1.11 billion or \$0.07/gallon. The deep tunnels when completed, will cost \$2.51 billion or \$1.09/gallon.

More information at <http://www.mwrdgc.dst.il.us/plants/tarp.htm>

ATLANTA, GA

Responsible Agency: City of Atlanta
Department of Public Works

Population Served: 1.5 million

Service Area: 260 sq. mi.

Sewer System: 230 mi. of combined sewer and 1,970 mi. of separate sewer

Near-Surface Storage Facilities and Tunnels

Twenty percent of Atlanta's sewershed is composed of combined sewers, which includes the most highly developed area of downtown Atlanta. The city started to control CSOs in the mid-1980s, using a mix of near-surface storage facilities, deep tunnels, and sewer separation projects. The Intrenchment Creek Tunnel, which has a diameter of 26 feet and is 1.76 miles long, can store 30-34 MG of excess wet weather flows. It can be de-watered in one to two days, by sending the stored flows for physical and chemical treatment at the associated Intrenchment Creek

Treatment Facility. During a study performed from August 1999 to January 2000, fecal coliform levels in the effluent from the Intrenchment Creek Facility were below the water quality standard that requires a geometric mean of 1,000 MPN col/100 mL.

The city also maintains one near-surface storage facility at the McDaniel CSO Facility. This near-surface storage basin holds 2 MG of combined sewage. The combination of tunnel and near-surface storage creates a total storage volume of 36 MG. This storage has reduced the frequency of CSO events from 50-60 times per year to approximately 17 per year. The Intrenchment Creek CSO project cost was approximately \$42.2 million or \$1.24/gallon. The McDaniel CSO Facility was constructed for \$9.2 million or \$1.53/gallon.

More information at <http://www.atlantapublicworks.org>

PROVIDENCE, RI

Deep Tunnel Storage

Responsible Agency: Narragansett Bay Commission

Population Served: 360,000

Service Area: 110 sq. mi.

Sewer System: 89 mi. of interceptor sewer

The Combined Sewer Overflow Abatement Program being implemented by the Narragansett Bay Commission will reduce the frequency of CSO events from 71 to four per year. The plan includes sewer separation projects as well as construction of storage and treatment facilities. The project is divided into three phases. The main component of the first phase is a deep tunnel. The tunnel is 27 feet in diameter, 200-300 feet below the ground surface, and 2.5 miles long. The tunnel's storage volume is 56 MG, and it is designed to be de-watered within 24 hours. Phase I is expected to reduce CSO volume by 40 percent; the entire project is expected to reduce CSOs by 98 percent. Construction of Phase I started in 2002 and will be completed in 2009. Phase I will be followed by a two-year monitoring period to assess improvements in water quality as a result of the tunnel. The final completion date of the entire project is contingent on the success of Phase I. It is anticipated that the reduction in CSOs to Narragansett Bay will contribute to reductions in shellfish bed closures. The estimated construction cost for the deep tunnel is over \$258 million or \$4.61/gallon.

More information at <http://www.narrabay.com/CSO.asp>

BANGOR, ME

Kenduskeag East CSO Storage Facility

Responsible Agency: City of Bangor Sewer Division

Population Served: 33,000

Service Area: 6.4 sq. mi.

Sewer System: 33.21 mi. of sewer, 30 percent combined

Bangor began development of a CSO long-term control plan in 1992. Initially, the city separated a portion of its sewer system. The sewer separation projects were followed by the installation of three storage facilities, including the Kenduskeag East CSO Storage Facility. The 1.2 MG near-surface storage facility is located underneath an existing public parking lot. Stored flows are released back into the sewer system for treatment at the WWTP. The basin has a small on-line portion through which dry weather flows pass everyday. During a wet weather event, when levels rise to 3.5 feet in the on-line portion of the basin, wastewater spills over into the off-line portion. The off-line portion is comprised of five box section rows that are 360 feet long and 8 feet wide. The basin's flushing system utilizes stored flow to create waves that clean settled solids from the bottom of each section. The wastewater level in the basin is monitored electronically, and if the basin reaches capacity, the monitoring system opens control gates that allow for a controlled and measured CSO event. The construction cost of the storage tank was \$2.3 million or \$1.92/gallon.

More information at http://www.precast.org/pages/Solutions/Summer_2002/overflow_in_bangor.html

GRAND RAPIDS, MI

Market Ave. Near-Surface Storage Facility

Responsible Agency: Grand Rapids Public Works

Population Served: 261,000

Service Area: 750 sq. mi., 3.9 sq. mi. is combined

Sewer System: 850 mi. of sewer

The Grand Rapids wastewater service area includes the city of Grand Rapids and six other surrounding towns. The CSS area is small and consists of only a half percent of the entire service area. In the early 1990s, the city created a plan to deal with the excess wet weather flows from this area. Part of this plan was the Market Avenue near-surface storage facility. The design included a multi-stage basin with treatment facilities to control the 10-year, one-hour storm. The 30.5 MG basin has three compartments which are operated sequentially. The first compartment allows for primary settling and grit removal. Once this compartment is full, the second compartment begins to fill. The bottom of the second compartment is equipped with a floor wash system. If the second compartment reaches its capacity, the excess flow spills over into the third compartment where sodium hypochlorite is added for disinfection. The third compartment discharges the partially treated and disinfected flow to the Grand River. The near-surface storage facility came on-line in 1992. Since this time, there has been a noticeable decline in fecal coliform levels in the Grand River. As an example, in 1989, the annual geometric mean for fecal coliform was 500 MPN/100 mL, and in 1996, the value was 75 MPN/100 mL. The city believes the reduction can be attributed to the 90 percent reduction in discharges of untreated CSOs. The construction cost for the Market Avenue near-surface storage facility was \$39 million or \$1.24/gallon. Operation and maintenance costs are approximately \$40,000/year or \$0.001/gallon.

More information at <http://www.epa.gov/owm/mtb/csoretba.pdf>

FAIRPORT HARBOR, OH

Converted Surface Storage Facility

Responsible Agency: Lake County Regional Sewer District

Population Served: 3,180

Service Area: Not available

Sewer System: Separate sewer system

Fairport Harbor Village is a historic town located on Lake Erie in Ohio. The separate sewer system that serves the city receives considerable I/I, which can be linked to the system's aged clay pipes. In 1994, engineering investigations determined that 1.8 MG of storage was needed to contain the wet weather flows associated with a five-year design storm event. The original proposal to build a near-surface storage facility near a major overflow point was rejected largely on the basis of citizen complaints. An alternative industrial site with an aging oil storage tank built in the 1940s was viewed more favorably, and had the potential to provide 3.2 MG of storage. Further investigations demonstrated the feasibility of converting the oil tank into an off-line storage tank. It was also found that even with extensive rehabilitation, the tank would provide a savings of \$170,000-\$500,000 when compared to the construction of a new facility. Rehabilitation of the oil tank included the removal of lead-based paint, asbestos-covered exterior piping, crude oil sludge, and interior pipes. A majority of the vertical and horizontal welds were replaced to meet current standards. In addition to rehabilitation of the tank, a new 5 MGD pump station and a one mile long force main were installed to convey flows to the tank. The cost of the Fairport Harbor storage facility was \$3.1 million or \$0.97/gallon.

Contact: Phillip Shrout, CT Consultants

References

EPA Office of Research and Development. 1993. *Manual: Combined Sewer Overflow Control*. EPA 625-R-93-007.

EPA Office of Water. 1994. *Combined Sewer Overflow (CSO) Control Policy*. EPA-830-B-94-001.

EPA Office of Water. 1999. *Combined Sewer Overflow Technology Fact Sheet - Retention Basins*. EPA-832-F-99-042. .
<http://www.epa.gov/owm/mtb/csoretba.pdf>

Gray, W. *et al.* 1999. *Prevention and Control of Sewer System Overflows: WEF Manual of Practice No. FD-17*. Alexandria: Water Environment Federation.

Milwaukee Metropolitan Sewerage District. "Sewer Operations Under Different Weather Conditions." Retrieved September 20, 2002. .
<http://www.mmsd.com/deeptunnel/sewersystem.asp>

Narragansett Bay Commission. 1998. *Combined Sewer Overflow Abatement Program Concept Design Report Amendment*. Providence, RI: Narragansett Bay Commission.

Wayne County Department of Environment. "CSO Demonstration Projects." Retrieved September 17, 2002. .
<http://rougerivercom.readyhosting.com/cso/projects.html>

Inclusion of this technology description in this Report to Congress does not imply endorsement of this technology by EPA and does not suggest that this technology is appropriate in all situations. Use of this technology does not guarantee regulatory compliance. The technology description is solely informational in intent.

Flow equalization basin (Borough of Lansdale)



On-Site Storage

Overview

Many sewer systems experience high flow rates during wet weather periods. The use of storage facilities to attenuate and store peak wet weather flows is widely implemented to reduce or eliminate CSOs and SSOs. On-site storage, that is storage developed at the wastewater treatment facility, is often an effective control for managing excess wet weather flows in systems where sewer system conveyance capacity exceeds that of the treatment plant.

The two most common forms of on-site storage are flow equalization basins (FEBs) and converted abandoned treatment facilities. Flow equalization is used to overcome operational problems caused by flow rate variations, to improve the performance of downstream processes, and to reduce the size and cost of downstream facilities (Metcalf & Eddy 2003). FEBs are typically located downstream of screening and grit removal facilities, but they can be placed just before the headworks of the treatment plant. FEBs can be configured in two general ways. The FEB can be placed within the flow path, meaning that all flow reaching the treatment plant passes through the basin, or it can be placed outside the flow path, where wet weather flows that exceed plant design capacity are diverted into the basin. Both configurations are shown in Figure 1.

On-site storage capabilities may also be developed in abandoned treatment facilities such as: old clarifiers that have since been replaced; treatment lagoons or polishing ponds no longer needed after the construction of more modern treatment facilities; or pretreatment facilities at industrial sites near the treatment plant. Storing flows in abandoned facilities may require modification of the current wastewater flow path; a flow control device and piping may be needed to transport flows to and from the storage facility. It may be possible to retrofit existing piping for this purpose, otherwise new piping and a pump, if needed, will have to be installed.

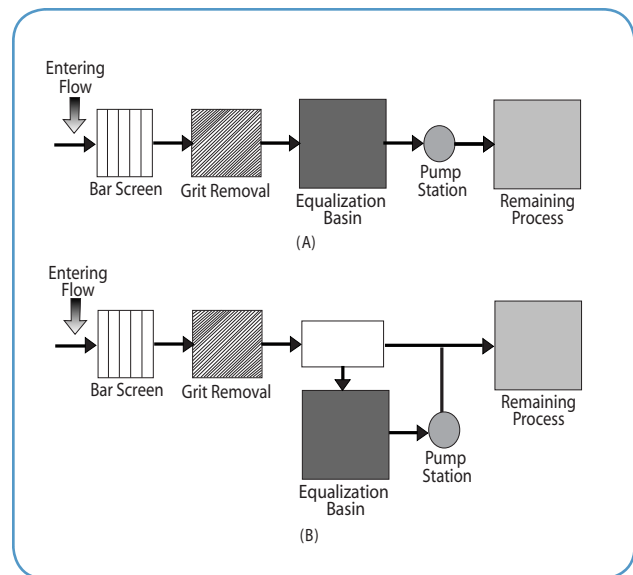

Figure 1. **Alternative locations for flow equalization basins (Metcalf & Eddy 2003).**

There are three primary design considerations related to on-site storage facilities: sizing and locating the facility, handling settled solids, and pumping systems to return stored flows for treatment. The best location for an on-site storage facility will vary with the characteristics of the sewer system, the wastewater, and the type of treatment required (Metcalf & Eddy 2003). The size of the storage facility will depend on the wet weather volume it is designed to hold, and the amount of land available at the treatment plant for construction, if needed.

On-site storage facilities must be designed to handle the solids present in the wastewater. For example, in Oklahoma the state design standards require storage facilities to be constructed with a minimum of two compartments (OKDEQ 2002). One compartment, which is lined with concrete or asphalt, is where the solids are allowed to settle. The other compartment holds overflow from the first, during moderate or large wet weather events. The

settled solids are washed back into the headworks of the treatment plant, allowing them to receive full treatment. Other facilities utilize mixing to prevent the deposition of solids. Mixing equipment requirements can be minimized by constructing on-site storage downstream of grit removal facilities. Examples of effective mixing mechanisms for storage facilities include tipping weirs and flushing gates. Aeration systems may be necessary if storage basins are susceptible to becoming oxygen-deprived and septic.

Variable or constant speed pumps may be used to return stored flows to the treatment plant. A constant speed pump will return flows at the same speed independent of the volume of flow stored, whereas a variable speed pump can be adjusted depending on the stored volume. A flow-measuring device should be installed to monitor the return of the stored flow.

While the volume of an on-site storage facility can be very large, there will be occasions when wet weather flows will exceed storage capacity. A mechanism to discharge flows that exceed facility capacity, with or without treatment, must be available.

Key Considerations

Applicability

On-site storage at the wastewater treatment plant can be a viable alternative for reducing or eliminating CSOs and SSOs. There are a number of important considerations that must be evaluated to determine the applicability of on-site storage at a given wastewater treatment plant. These include:

- Maximum flow that can be conveyed to the treatment plant;
- Maximum flow that can be treated with the existing treatment processes;
- Availability of land on site for the construction of a new FEB; and
- Location and volume of abandoned treatment facilities.

Advantages

On-site storage can play an important role in improving wet weather treatment plant operations. It provides operators with the ability to manage and store excess flows,

which helps maintain treatment efficiency and ensures that all flows reaching the plant receive the maximum treatment possible. Development of on-site storage can also facilitate operation and maintenance activities. If problems occur at on-site facilities, it is likely that they will be detected earlier, and that many of the tools required to make the needed repairs will already be at the treatment plant.

Constructing storage outside the bounds of the wastewater treatment plant typically requires an environmental site assessment. Site assessments are less likely to be required for on-site storage facilities because the storage is being placed in a location that has already been approved for such use. If an assessment is needed, the requirements may be less rigorous since environmental conditions at the wastewater treatment plant are known and may have already been investigated.

Disadvantages

There are limitations to on-site storage that must also be considered. Development of a large FEB uses space that might be needed for future plant expansion. Restored facilities, because of their age, may deteriorate faster than a new facility. The conveyance system or plant headworks may limit the amount of wet weather flow that can be brought to the treatment plant. The headworks can be expanded, but it can be costly to expand the conveyance system capacity. Finally, as with any storage facility, on-site storage has finite capacity which may not be sufficient to prevent CSOs and SSOs during extreme wet weather events.

Cost

The costs associated with the development of on-site storage facilities range from as little as \$0.01 per gallon to more than \$1.00 per gallon. These costs are, on average, considerably lower than the construction costs for typical near-surface storage facilities built outside the bounds of the treatment plant. Much of the cost savings derives from being able to site the storage facilities on land already owned by the utility. The following table presents cost information from a number of on-site storage applications.

Table 1. Summary of on-site storage costs.

Municipality	Technology	Characteristics	Year Initiated	Approximate Construction Cost ¹
Auburn, NY	Restored Storage	Total Storage = 0.2 MG Cleaned annually	1997	\$930,000 or \$4.65/gallon
Barlesville, OK	Flow Equalization Basin	Total Storage = 20 MG Sewer system also includes two other FEBs	1986	\$1.70 million or \$0.08/gallon
Cleveland, OH	Restored Storage	Total Storage = 6 MG Converted Imhoff Tanks	1985	\$18.3 million or \$3.05/gallon
Covington, LA	Flow Equalization Basin	Total Storage = 6 MG Cleaned annually	1997	\$1.22 million or \$0.20/gallon
Idabel, OK	Flow Equalization Basin	Total Storage = 10 MG	1999	\$450,000 or \$0.05/gallon
Lafayette, LA	Flow Equalization Basin	East WTPP: Total Storage = 3 MG	1999	\$1.6 million or \$0.53/gallon
		West WTPP: Total Storage = 3.5 MG	1999	\$1.9 million or \$0.54/gallon
Oakland, ME	Restored Storage	Total Storage = 0.2 MG FEB from a closed textile mill	1998	\$27,610 or \$0.14/gallons
South Paris, ME	Restored Storage	Total Storage = 1.5 MG Clarifiers from old tannery	1995	Annual Debt Service: \$110,000 or \$0.07/gallon
Tulsa, OK	Flow Equalization Basin	Total Storage = 13 MG	1994	\$3.81 million or \$0.35/gallon
Vinita, OK	Holding Ponds	Total Storage = 7MG Two holding ponds with capacity of 3.5 MG each	1996	\$94,000 or \$0.01/gallon

¹ All costs are in 2002 dollars.

² South Paris, ME, reported negligible construction costs associated with restoring their abandoned on-site facilities. The cost numbers presented reflect annual operation and maintenance for the facilities.

³ Vinita, OK, approximate construction cost does not include land or other facility improvement costs.

Implementation Examples

AUBURN, NY

Responsible Agency: City of Auburn
Department of Municipal Utilities
Population Served: 35,000
Service Area: Not Available
Sewer System: Not Available

Reusing Primary Treatment Facilities

In 1993, the City of Auburn began efforts to control both their CSOs and I/I within the separate sewer portion of their system. This included the conversion of primary settling tanks, originally built in the 1930s, into storage for wet weather events. When wet weather flows exceed the treatment plant's 25 MGD capacity, excess influent is directed to the settling tanks. Four tanks, with a combined capacity of approximately 158,000 gallons, serve as storage. When the capacity of the storage tanks is fully utilized, two additional tanks are used to provide high-rate disinfection and dechlorination before flows are discharged.

To modify the tanks, the primary sludge collectors were removed. A flushing system was then installed to wash the system after a wet weather event. Weirs were installed to permit flow between the tanks. Odors associated with the facility are minimized by returning the entire stored volume to the treatment plant within 24 hours of the wet weather event. Annually, the retrofitted primary settling tanks capture 5.8 MG of excess flow. The facility captures 76 percent of the possible overflows, which are returned to the plant for full treatment; the volume that does overflow receives primary treatment and disinfection. The conversion of the primary settling tanks into wet weather storage facilities cost \$930,000 or \$4.65/gallon.

Contact: Frank DeOrio, City of Auburn

CLEVELAND, OH

Responsible Agency: Northeast Ohio Regional
Sewer District (NEORS D)
Population Served: 500,000
Service Area: 355 sq. mi.
Sewer System: Not Available

Reusing Imhoff Tanks

In order to reduce CSO discharges, NEORS D refurbished old Imhoff tanks located at the Westerly wastewater treatment plant to store combined sewage. The Imhoff tanks required reconfiguration for CSO storage; in addition, sludge removal equipment, bar screens, flow control gates, and an effluent conduit and pump were installed. The tanks can store approximately 6 MG and the related interceptor can hold an additional 6 MG, for a total storage of approximately 12 MG. Volumes which exceed the

storage capacity are disinfected and then discharged. The conversion of the tanks was completed in 1985. The storage at the Westerly plant has helped reduce CSO discharges to the Edgewater State Park swimming beach on Lake Erie. The conversion of the Imhoff tanks into CSO storage facilities cost \$18.3 million or \$1.53/gallon.

Contact: Frank Greenland, Northeast Ohio Regional Sewer District

LAFAYETTE, LA

Responsible Agency: Lafayette Utilities System
Population Served: 37,500
Service Area: 38 sq. mi.
Sewer System: 650 mi. of separate sewer

Flow Equalization Basins

In the mid 1990s, the Lafayette Consolidated Government started to look at inflow and infiltration (I/I) problems prevalent in their sanitary sewer system. After surveying, rehabilitating, and maximizing flow to the treatment plants, the Utilities decided to construct FEBs at their East and South wastewater treatment plants. The FEBs were constructed as part of a larger project that included other plant upgrades. The East and South wastewater treatment

plants' FEBs can hold 3 MG and 3.5 MG, respectively. When flows exceed the maximum flow rate which can be handled by the plant, a portion of the flow is diverted to the FEB, to protect the treatment processes. Once the wet weather flows subside, the plants continue to operate at maximum capacity while the basins are drained. Emptying the FEBs can take one to three days. Since the FEBs have been in operation, hydraulic overload violations have been reduced from an average of six to nine annually to zero. The estimated cost for the East FEB was \$1.6 million or \$0.53/gallon. The estimated cost for the South FEB was \$1.9 million or \$0.54/gallon.

More information at <http://www.lus.org/site.php?pageID=2>

OAKLAND, ME

Responsible Agency: Oakland Public Works
Population Served: 6,000
Service Area: Not Available
Sewer System: 7 mi. of sewer

Restored Flow Equalization Basin

Oakland's sewer system consists mainly of combined sewers. The city has been implementing CSO controls since 1997. These efforts include separating a portion of the combined sewer system and other targeted inflow reduction activities. As a result, Oakland has been able to eliminate both of its CSO outfalls and transport all remaining wet weather flows to its wastewater treatment plant. Although the city had sufficient sewer system capacity to

transport these wet weather flows, it did not have treatment facilities capable of handling the peak wet weather flow. The city was able to utilize an FEB installed at the treatment plant for a nearby textile mill that had since ceased operation. The FEB was built in 1990 by the textile mill as part of their pretreatment program, but had sat unused since the mill closed shortly afterwards. Oakland is able to store 0.2 MG of excess wet weather flows in the basin, and then bleed it back to the wastewater plant for treatment as capacity becomes available. The FEB is available to the city year-round, but is mainly used during spring snow melts. To bring the FEB back into operation will cost approximately \$27,610 or \$0.14/gallon; operational costs are minimal.

Contact: Jim Fitch, Woodard and Curran

SOUTH PARIS, ME

Clarifiers from Old Tannery Storage

Responsible Agency: Paris Utility District
Population Served: 1,000
Service Area: Not Available
Sewer System: 16.3 mi. of combined sewer

The combined sewer system owned and operated by the Paris Utility District has one overflow point. Utilization of an unused pretreatment facility for storing excess wet weather flows has enabled the District to reduce the frequency of CSO events. The District's wastewater system was designed with pretreatment facilities for the two major industries in the city, a tannery and a cannery. The tannery pretreatment facility is considered part of the

South Paris wastewater treatment plant. The tannery closed in 1985. In the mid 1990s, the tannery pretreatment facility was brought back into service to store excess wet weather flows from the District's CSS and provide primary treatment during extreme events. The tannery facility provides a total storage volume of 1.5 MG. Costs for returning the tannery facility to service were minimal because the infrastructure was already in place; operation and maintenance costs are also quite small. The only true cost of the tannery storage is its portion of the facilities debt service for plant modifications, which costs approximately \$110,000 annually or \$0.07/gallon.

Contact: John Barlow, Paris Utility District

TULSA, OK

Flow Equalization Basins

Responsible Agency: Tulsa Public Works
Population Served: 85,000
Service Area: Not Available
Sewer System: 1,800 mi. of sewer

Tulsa's separate sanitary sewer system is divided into three major sewersheds, with a wastewater treatment plant located in each. Multiple sanitary sewer evaluations have been performed to help Tulsa establish a plan for controlling SSOs. SSO abatement efforts in the Northside Sewershed have facilitated on the attenuation of storage of excess wet weather flows. Tulsa has constructed three near-surface storage basins located remotely in the Northside Sewershed, and

one FEB located within the bounds of the wastewater treatment plant. The four basins together provide a total of 83.2 MG of storage, with the treatment plant FEB accounting for 13 MG. The treatment plant site is large enough to accommodate the FEB as well as all anticipated future additions to the plant. The Northside FEB is used when a large wet weather event overwhelms the capacity of the three upstream storage basins. The construction cost for the Northside FEB was approximately \$3.81 million or \$0.35/gallon.

More information at <http://www.cityoftulsa.org/Public+Works/wastewater/wastewater+treatment+process.htm>

References

Metcalf and Eddy, Inc. 2003. *Wastewater Engineering: Treatment, Disposal, and Reuse, 4th ed.* Boston: Irwin McGraw Hill.

Oklahoma Department of Environmental Quality (OKDEQ). 2002. "Title 252: Oklahoma Administrative Code Chapter 656 Water Pollution Control Facility Construction." Retrieved January 27, 2003. <http://www.deq.state.ok.us/rules/656-correction.pdf>

Inclusion of this technology description in this Report to Congress does not imply endorsement of this technology by EPA and does not suggest that this technology is appropriate in all situations. Use of this technology does not guarantee regulatory compliance. The technology description is solely informational in intent.



TECHNOLOGY DESCRIPTION

Treatment Technologies

Supplemental Treatment

Overview

When wet weather flow rates exceed available sewer system or treatment capacity, constructing supplemental treatment facilities may be a cost-effective alternative to expanding existing conveyance capacity or treatment facilities. Supplemental treatment facilities are designed solely to treat excess wet weather flows; the level of treatment provided is typically driven by regulatory requirements.

Supplemental treatment facilities can be located and configured in multiple ways, including:

- Providing treatment at established overflow locations by installing a small scale treatment process at or near a known CSO or SSO location. For example, a vortex separator with disinfection capabilities might be installed near a CSO outfall. The treated effluent would be discharged directly to a receiving water.
- Constructing a separate treatment facility upstream of the existing treatment plant. Such a facility would accept and treat excess wet weather flows that might otherwise result in untreated CSOs or SSOs from one or more locations in the sewer system; for example, a ballasted flocculation treatment process constructed in a capacity-constrained area of the sewer system. Effluent would be discharged directly to a receiving water from this facility.
- Adding parallel treatment process(es) at the existing treatment plant that would operate as necessary during wet weather. To be successful, this requires sufficient sewer system capacity to deliver wet weather flows to the existing treatment plant. Effluent from the parallel treatment process would be discharged directly or recombined with flows from existing treatment units prior to discharge.

For any of these configurations, the selection of a specific supplemental treatment technology will be driven by wet weather flow characteristics. Important characteristics to consider include:

- Frequency of wet weather events requiring supplemental treatment;
- Limited event duration, often lasting less than 24 hours;
- High flow rate and volume with potential peak wet weather flows of four to 20 times the average daily flow; and
- Weak influent pollutant concentrations, diluted by storm water inflow/infiltration (I/I).

These flow characteristics can pose technical challenges to efficient and effective treatment. Supplemental treatment facilities must be able to handle sudden increases in flow at unplanned times, have quick start-up time, or in the case of biological processes, quick acclimation time after extended periods of no flow (or low flow conditions), and provide adequate treatment despite significant variation in influent pollutant concentrations.

The technologies best suited for treating excess wet weather flows commonly involve physical or chemical processes rather than biological processes. The applicability of biological treatment processes is limited by factors including:

- Biological processes do not respond well to adverse, intense, and intermittent flow conditions typical of wet weather events.
- Rapid changes in the amount and quality of the influent reduce biological process treatment efficiency. In some cases, large hydraulic loads can wash out the microorganisms necessary for treatment.
- Microorganisms need a minimum level of food (i.e., organic matter) in the influent to survive. Therefore, it is often technologically and operationally difficult, if not impossible, to maintain a large enough microorganism population during dry weather or low flow periods, so that there is a sufficient population available for biological treatment of large wet weather flows.

Trickling filters are the biological treatment technology option considered most operationally feasible for treating excess wet weather flows. This is based on their ability to handle peak flow conditions with less likelihood of upset, relative to conventional activated sludge processes (WEF 1998). In a trickling filter system, microorganisms are maintained as a biological film attached to a fixed media. In contrast, microorganisms in an activated sludge process are suspended in a less stable, liquid media. Nonetheless, supplemental treatment facilities with any biological process must operate continuously with a minimum flow rate to maintain the biomass necessary for treatment of wet weather flows. During dry weather, effluent from biological supplemental treatment facilities is typically returned to the sewer system for further treatment and discharged at the wastewater treatment plant.

A number of physical and chemical treatment technologies are suited for use as supplemental treatment facilities handling excess wet weather flows. These include:

Primary clarification

Excess wet weather flows enter a large basin where the velocity of flow decreases, allowing solids to settle to the bottom of the tank and floatable materials (e.g., grease and debris) to rise. Mechanical equipment skims the floating material, while other mechanical devices collect and remove settled material from the bottom of the basin.

Screening

Excess wet weather flows are strained through a mesh of metal, plastic, ceramic, or cloth. Solids are collected on the surface of the screen where they are removed by mechanical scraping, a spray mechanism that washes solids off the screen, or by gravity. Various screen aperture sizes are available; solids removal efficiency decreases as the aperture increases.

Vortex separators

Vortex separators use centripetal force, inertia, and gravity to remove floatables, trash, and other settleable solids from excess wet weather flows. Additional information on vortex separators is presented in “Vortex Separators Technology Description” in Appendix B of the *Report to Congress on Impacts and Control of Combined Sewer Overflows and Sanitary Sewer Overflows*.

Ballasted flocculation

In ballasted flocculation or sedimentation, a metal salt coagulant is added to the excess wet weather flows to aggregate suspended solids. Then, fine-grained sand, or ballast, is added along with a polymer. The polymer

acts like glue which bonds the aggregated solids and sand. The process increases the particles’ size and mass which allows them to settle faster. The high dosages of flocculent may require pH adjustments.

Chemical flocculation

Similar to ballasted flocculation, chemical flocculation is a high-rate treatment process that adds metal salts and polymers to clump particles together. Depending on their density, the clumps will either sink to the bottom or float to the surface where they can be removed.

Deep bed filtration

A deep bed filter system consists of a series of large tanks (depths greater than 6 feet) filled with coarse medium (typically sand or anthracite). Excess wet weather flows are directed to the top of each tank and exit at the bottom of the tank. Pollutants can either attach to the filter media or become trapped in the interstitial space of the filter; the filter is later cleaned through backwashing. Chemical additives can be used to improve removal rates.

Key Considerations

Applicability

Supplemental treatment facilities are not intended to treat dry weather flows from combined or sanitary sewer systems, although biological facilities will need to be operated continually. The type and location of supplemental treatment facilities will be driven by site-specific considerations, which include:

- State and federal permit requirements and effluent limits;
- Characteristics of the excess wet weather flows;
- Land or space constraints;
- Capacity constraints within the existing sewer system or treatment facility;
- Anticipated population growth; and
- Financial resources.

For example, if available land is a constraint, a facility with a large “footprint” would not be appropriate. Alternatively, if the existing sewer system cannot convey all of the wet weather flow to the WWTP, a supplemental treatment facility upstream of the plant may be the most practical alternative.

It should be noted that primary clarification and trickling filter technologies can have a difficult time handling the highly variable flows associated with wet weather

events; these technologies may, therefore, require some type of flow equalization to operate efficiently. Adequate disinfection of treated excess wet weather flows is also a concern. High flow rates can result in reduced exposure to the disinfecting agent and reduced pathogen inactivation. Increased solid concentrations may also exist in treated wet weather flows, which can shield pathogens from exposure to the disinfectant. Specific wet weather considerations

related to disinfection technologies are discussed in more detail in the “Disinfection Technology Description” in Appendix B of the *Report to Congress on Impacts and Control of Combined Sewer Overflows and Sanitary Sewer Overflows*. The advantages and disadvantages of each of the aforementioned supplemental treatment processes are summarized in Table 1.

Table 1. Advantages and disadvantages of various supplemental treatment technologies.

Technology	Advantages	Disadvantages
Primary Clarification	<ul style="list-style-type: none"> • Little manual operation 	<ul style="list-style-type: none"> • Large “footprint” • Reduced retention and settling time (i.e., residence time) and possible short circuiting during high flow rates • Lack of removal of dissolved or soluble pollutants • Need for significant periodic maintenance requirements
Screening	<ul style="list-style-type: none"> • Small “footprint” • Little manual operation • High reliability with proper operations and maintenance (O&M) • Low energy consumption 	<ul style="list-style-type: none"> • Susceptible to clogging or poor solids removal • Require regular operator observation, especially microscreens • Prompt solids disposal required due to potential odor problems • Incomplete removal of solids from wastewater (coarse and fine screens generally only remove floatables and visible solids) • High cost for high performance microscreens
Vortex Separation	<ul style="list-style-type: none"> • Small “footprint” • Ability to handle high hydraulic loading rate • No moving parts (no mechanical maintenance) • Low construction cost 	<ul style="list-style-type: none"> • Inability to remove fine solids and dissolved or soluble pollutants • Loss of floatables to overflow during extremely high flows • Potential loss of foam and floatables in initial overflow • Manual cleaning needs for settled solids
Ballasted Flocculation	<ul style="list-style-type: none"> • Small “footprint” (typically 5-15 percent of the space required for conventional primary clarification) • Ability to handle high hydraulic loading rate(s) • Reduced capital cost relative to conventional clarification • Ability to treat rapidly varying flows • Ability to consistently achieve secondary treatment concentration standards for BOD and TSS 	<ul style="list-style-type: none"> • Limited ability to remove soluble pollutants • Increased operational cost relative to biological treatment or conventional clarification due to the cost of the chemicals and sludge disposal along with ballasted media
Chemical Flocculation	<ul style="list-style-type: none"> • Production of concentrated sludge, requiring no additional thickening equipment • Ability to handle high hydraulic loading rate • Ability to treat rapidly varying flows 	<ul style="list-style-type: none"> • Limited ability to remove soluble pollutants • Potential increase in sludge produced due to the addition of treatment chemicals • Increased operational costs relative to biological treatment or conventional clarification due to the cost of the chemicals
Deep Bed Filtration	<ul style="list-style-type: none"> • Ability to treat high and rapidly varying flows • Ability to consistently achieve secondary treatment concentration standards for BOD and TSS 	<ul style="list-style-type: none"> • High initial construction costs • Limited ability to remove soluble pollutants • Frequent backwash requirements to avoid clogging
Trickling Filters	<ul style="list-style-type: none"> • Small “footprint” • Ability to achieve all secondary treatment requirements • Rapid reduction of soluble BOD in wet weather flow • Ability to treat high and rapidly varying flows 	<ul style="list-style-type: none"> • Continuous operation required • Degraded removal efficiencies when excess biomass exists • High clogging potential • Regular operator supervision and maintenance requirements • Potential odor and snail population problems

Cost

Performance information for each of these technologies is presented in Table 2. Screening data are presented according to screen aperture size in millimeters. Typical performance for hydraulic loading capacity, BOD removal, and TSS removal is presented where available. The range in observed performance is largely due to changes in either hydraulic loading rates or influent characteristics (e.g., concentration, fraction of soluble pollutants). Where typical ranges were

not available, data for performance at a single location are provided with notation.

Capital cost information for each supplemental treatment technology is summarized in Table 3. Cost per gallon of capacity is provided where possible.

The capital costs for biological trickling filters are generally greater than capital costs for physical and chemical alternatives. In comparing daily operating costs, biological processes are typically significantly less expensive to operate

Table 2. Performance data summary for supplemental treatment technologies.

Technology	Source(s)	Hydraulic Capacity (gpd/ft ²)	BOD Removal (Percent)	TSS Removal (Percent)
Primary Clarification	Metcalf and Eddy 1991; NEIWPCC 1998; WEF 1996	600-3,000	25-40	50-70
Screening	Metcalf and Eddy 1991			
Coarse (5-25 mm)		21,000-86,000	Not Available	15-30
Fine (0.1-5 mm)		150-1,400	Not Available	40-50
Micro (less than 0.1 mm)		150-1,400	Not Available	40-70
Vortex Separation	EPA 1996; Boner <i>et al.</i> 1995; WERF 2002	Up to and greater than 100,000	Up to 55 ^a	5-60
Ballasted Flocculation	Radick <i>et al.</i> 2001; Scruggs <i>et al.</i> 2001; Vick 2000; Poppe <i>et al.</i> 2001	Up to 90,000	65-80	70-95
Chemical Flocculation	Metcalf and Eddy 1991; Moffa 1997	Up to 20,000	40-80	60-90
Deep Bed Filtration	Ellard <i>et al.</i> 2002	Not Available	65 ^b	87 ^b
Trickling Filters (with settling) ^c	Metcalf and Eddy 1991; WEF 1998	Up to 11,000	40-90	Not Available

^a Based on two monitored events (Boner *et al.* 1995); limited data exist since BOD is not a common performance indicator for vortex separators.

^b Average performance based on pilot test data from Jefferson County, Alabama (Ellard *et al.* 2002).

^c High-rate trickling filters achieve 65-85 percent BOD removal. Related technologies, including rotating biological contactors and packed-bed reactors, use the same processes as trickling filters and have similar removal rates, advantages, and disadvantages.

because of the chemical costs associated with physical or chemical treatment. Supplemental biological treatment processes need to be operated continuously, however, so the actual annual operating costs for a biological supplemental process will likely be greater than for a physical or chemical supplemental process. For example, annual operation and maintenance (O&M) costs for a 10 MGD trickling filter facility are estimated at \$150,000 (EPA 2000). Assuming it operates 365 days per year, daily operating costs are \$411 per day. In comparison, annual O&M costs for a 10 mgd

ballasted flocculation facility are estimated at \$49,000 (Wendle 2002). Assuming this facility operates eight days per year (a conservative estimate based on an expected two to four events per year in Lower Paxton Township), daily operating costs are \$6,125 per day.

Table 3. Performance data summary for supplemental treatment technologies.

Technology	Source	Capacity (MGD)	Estimated Total Capital Cost ^a	Unit Cost ^a (Per Gallon/Day of Capacity)
Primary Clarification	Hufford 2001	78	\$11.0 million	\$0.14
Screening	EPA 1999	0.75-375	\$40,800-\$2.2 million	\$0.01-\$0.05
Vortex Separation	Sacramento 1999	1.8 - 16.2 ^b	\$10,000-\$50,000	\$0.01
Vortex Separation with Screening	Sacramento 1999	0.71-194	\$13,000-\$630,000	\$0.01-\$0.02
Ballasted Flocculation	Wendle 2002	15	\$5.5 million	\$0.37
	Hufford 2001	78	\$12.4 million	\$0.16
	WERF 2002	100	\$20.0 million	\$0.20
	Bremerton 2002	20	\$4.0 million ^c	\$0.20
Chemical Flocculation - Aluminum as Additive	Hewing <i>et.al.</i> 1995	Not Available	\$0.50 (cost per pound)	\$0.04 (per gallon treated) ^d
Chemical Flocculation - Ferrous Sulfate as Additive	Hewing <i>et.al.</i> 1995	Not Available	\$0.17 (cost per pound)	\$1.03 (per gallon treated) ^d
Deep Bed Filtration	Chandler 2001	360	\$55 million ^e	\$0.15
Trickling Filters	EPA 2000	1-100	\$760,000-\$63.4 million	\$0.63-\$0.76

^a Costs in 2002 dollars.

^b Vortex separator capacities are hydraulic capacities. Manufacturer recommended design capacities for optimal TSS removal are generally 25 percent of the hydraulic capacities.

^c Includes costs for a 20 MGD Ultraviolet (UV) disinfection process. Cost for ballasted flocculation alone was not available.

^d Capital costs for chemical feed mechanisms not available. Treatment costs include chemical costs and sludge handling costs. Ferrous sulfate generates larger sludge volumes than aluminum, significantly increasing treatment costs.

^e Includes costs for a 360 MGD UV disinfection process. Cost for deep bed filtration alone was not available.

Implementation Examples

JEFFERSON COUNTY, AL

Deep Bed Filter to Manage Peak Wet Weather Flows

Responsible Agency: Jefferson County Environmental Services
Population Served: 232,000
Service Area: Not Available
Sewer System: 3,100 mi. of sewer

Jefferson County's Village Creek Wastewater Treatment Plant receives an average daily flow of 40 MGD; peak flows exceed 400 MGD once per year on average. Exceedence of available 120 MGD of primary treatment and disinfection capacity at the treatment plant occurs an average 41 times per year (based on data from 1997-2001). Flows exceeding the 60 MGD of secondary capacity occur more frequently. Elevated wet weather flows have continuously exceeded treatment capacity for as long as six days. A combination of rainfall patterns, topography, geology, and sewer system

age have contributed to extreme peak wet weather flow issues for the county.

Under consent decree, Jefferson County will spend approximately \$200 million for the construction of a deep bed filter supplemental treatment facility. The deep bed filter facility will be constructed on a 450-acre site and will discharge through a separate outfall. Construction is scheduled for completion in late 2003. During pilot testing of the filter technology, the best effluent and longest filter runs were achieved with no chemical addition. Pilot testing performance showed average removals of 87 percent of TSS and 65 percent of BOD, on average.

To prevent filter clogging from high influent flow and solids loadings, new methods of operating and backwashing were developed during the pilot study. These methods are now patented or patent-pending.

Deep bed filter construction costs.

Component	Contract Cost (Million)
Influent tunnel (15 foot diameter)	\$17.0
Pump station (360 MGD)	\$46.0
Surge basins (20 basins, total capacity: 90 MG)	\$54.2
Deep bed filters plus UV disinfection (360 MGD) (22 filters, each at 1,167 ft ²)	\$55.0
24 megawatt generator building and equipment (primarily for pump station and UV operation)	\$22.0
Site work/access, road, and miscellaneous	\$14.3
Total:	\$208.4

Contact: Harry Chandler, Assistant Director of Environmental Services, Jefferson County

SYRACUSE, NY

Microscreens to Treat CSOs

Responsible Agency: Onondaga County Public Utilities

Microscreen performance data (EPA 1979).

Aperture (microns)	23	71	105
Hydraulic loading rate (gpd/ft ²)	2,500-11,000	4,000-18,000	16,000-95,000
Average influent TSS concentration (mg/L)	619	308	284
Average effluent TSS concentration (mg/L)	290	172	196
Average TSS removal (Percent)	58	45	32

The Syracuse demonstration program evaluated the treatment of CSOs with screening. Three screening units, ranging from an aperture size of 23 microns to 105 microns, were used in this program. The table on the left lists the hydraulic loading rates and average TSS removal efficiencies associated with each of these microscreens. These results show that as aperture increases, hydraulic loading rates also increase. As aperture increases, however, the TSS removal efficiencies decrease.

Contact: Rich Field, EPA Office of Research and Development, Edison, NJ

TACOMA, WA

Ballasted Flocculation to Manage Wet Weather Flow

Responsible Agency: City of Tacoma

Population Served: 258,000

Service Area: Not Available

Sewer System: 700 mi. of sewer

The City of Tacoma's Central Treatment Plant (CTP) receives flow from a separate sanitary sewer system serving a population of 208,000. The CTP has a hydraulic capacity of 103 MGD (primary plus disinfection), and a peak biological treatment capacity of 78 MGD. The sewer system can currently deliver up to 110 MGD to the CTP.

The CTP has reached the criterion specified in their permit that triggers a requirement to develop a plan for maintaining adequate capacity. The city plans to install a 78 MGD ballasted flocculation process at the CTP parallel to the existing processes. The ballasted flocculation process alone will cost approximately \$12.4 million. All related peak wet weather flow facility upgrades are estimated at \$50.7 million. In comparison, to expand the existing activated sludge processes by 78 MGD would cost an estimated \$130 million; this estimate does not include the cost for additional primary clarification capacity.

During pilot testing, the ballasted flocculation process reached acceptable performance levels within 10-15 minutes of start-up. Pilot testing performance data, collected over a nine-day period, indicate effluent TSS concentrations below 30 mg/L (with the exception of the first day) and percent removals for TSS ranging from 79-92 percent. Effluent BOD concentrations ranged from approximately 20-42 mg/L, and removal rates for BOD ranged from 63-73 percent (Tacoma 2000). The lower percent removals generally occurred during weaker influent conditions.

When the actual ballasted flocculation process is constructed and operated for wet weather treatment, effluent from the process will be separately disinfected and blended with disinfected biologically treated effluent prior to discharge. The blended effluent is expected to meet permitted effluent concentrations and removal efficiencies. The ballasted flocculation process is expected to operate a maximum of 5.5 days in a row, 8 days in a month, and 21 days per year (Tacoma 2001).

Contact: David Hufford, Division Manager, Environmental Services/Wastewater Management, City of Tacoma

BREMERTON, WA

Ballasted Flocculation to Treat CSOs

Responsible Agency: City of Bremerton

Population Served: 37,000

Service Area: 5.2 sq. mi.

Sewer System: Not Available

The City of Bremerton maintains a partially combined sewer system that provides service to approximately 37,000 people. The WWTP receives an average annual flow of 7.6 MGD and has a peak hydraulic capacity of 29.5 MGD. During periods of wet weather, however, flows in excess of 38 MGD have been delivered to the plant. Currently, Bremerton has 16 permitted CSO outfalls. As part of their CSO long term control plan, the city constructed the Pine Road Eastside CSO Treatment Facility. The CSO treatment facility was completed in December 2001.

The facility uses ballasted flocculation in combination with UV disinfection. Total construction costs were \$4 million. The CSO treatment facility also includes a 100,000 gallon storage tank that was constructed in 2000 for an additional \$400,000 (Bremerton 2002).

No performance data are currently available for the constructed facility (Bremerton 2002). Pilot testing performance showed a 71 percent removal of TSS, 63 percent removal of total BOD, and 46 percent removal of soluble BOD, on average. During pilot testing, the ballasted flocculation unit reached peak efficiency within 10 minutes of start-up.

Contact: John Poppe, Wastewater Manager, City of Bremerton

References

- Boner, M.C., *et al.* 1995. "Modified Vortex Separator and UV Disinfection for Combined Sewer Overflow Treatment." *Water Science and Technology*. Vol. 31(No. 3-4).
- Bremerton, City of 2002. "City of Bremerton Public Works and Utilities' Wastewater/CSO Update." Retrieved December 11, 2002.
http://www.cityofbremerton.com/content/ww_csoupdate.html.
- Chandler, Harry, Assistant Director of Environmental Services, Jefferson County. Interview by Limno-Tech, Inc., Birmingham, AL. Fall/Winter 2001.
- Ellard, Gregory, Meek, R., and H. Chandler. 2002. *Direct Filtration for Wet Weather Conditions*. Presented at Water Environment Federation Technical Exhibition and Conference (WEFTEC) Chicago, IL. September 29 - October 2, 2002.
- EPA. 1979. *Disinfection/Treatment of Combined Sewer Overflows - Syracuse, New York*. Prepared by O' Brien and Gere Engineers, Inc. EPA 600-2-79-134.
- EPA. 1996. *Assessment of Vortex Solids Separators for the Control and Treatment of Wet-Weather Flow*. EPA 832-B-96-006.
- EPA, Office of Water. 1999. *Combined Sewer Overflow Technology Fact Sheet: Screens*. EPA 832-F-99-040.
- EPA, Office of Water. 2000. *Wastewater Technology Fact Sheet: Trickling Filters*. EPA 832-F-00-014.
- Hewing, Albert, *et al.* 1995. "Reducing Plating Line Metal Waste." *Pollution Engineering*.
- Hufford, David, Division Manager, Environmental Services/Wastewater Management, City of Tacoma. Interview by Limno-Tech, Inc., October 2001. Tacoma, WA.
- Metcalf and Eddy, Inc. 1991. *Wastewater Engineering: Treatment, Disposal, and Reuse*. 3rd Ed. Boston: Irwin McGraw Hill.
- Moffa, P.E. (Ed.). 1997. *Control and Treatment of Combined Sewer Overflows*. 2nd ed. New York: Van Nostrand Reinhold.
- New England Interstate Water Pollution Control Commission (NEIWPC). 1998. *Technical Report #16: Guides for the Design of Wastewater Treatment Works*. Wilmington, MA: NEIWPC.
- Poppe, John, Wastewater Manager, City of Bremerton. 2002. Interview by Limno-Tech, Inc., Fall 2002. Washington, DC.
- Poppe, John, *et al.* 2001. "High-Rate Wet Weather Solution." *Public Works*. Vol. 132 (No. 8).
- Radick, Keith A. and Morgan, Marc A. October 2001. *Ballasted Flocculation: A Technology for Long Term CSO Control*. Presented at Water Environment Federation WEFTEC Conference Atlanta, GA. October 13 - 17, 2001.
- Sacramento, County of. 1999. *Stormwater Management Program: Investigation of Structural Control Measures for New Development*. Prepared by Larry Walker Associates, Inc. Retrieved December 12, 2002
www.sacstormwater.org/const/manuals/pdf/scm99_scm99.pdf
- Scruggs, Caroline and C. Wallis-Lage. 2001. *Ballasted Flocculation: A Wet-Weather Treatment Solution?* Presented at Water Environment Federation WEFTEC Conference Atlanta, GA. October 13 - 17, 2001.
- Tacoma, City of. 2000. *Ballasted Sedimentation Pilot Study Report and Feasibility Analysis, Central Wastewater Treatment Plant, City of Tacoma*. Prepared by Parametrix, Inc. Sumner, WA: Parametrix.
- Tacoma, City of. 2001. *Facilities Plan: Central Wastewater Treatment Plant, City of Tacoma - Draft Final Edits*. Prepared by Parametrix, Inc. Sumner, WA: Parametrix.
- Vick, Rebecca Chambers. 2000. "High-Rate Clarification Takes the Prize." *Pollution Engineering*. Vol. 32 (No. 10).
- Water Environment Federation (WEF). 1996. *Operation of Municipal Wastewater Treatment Plants, Manual of Practice No. 11*. 5th Ed, Vol. 2. Alexandria, VA: WEF.
- Water Environment Federation (WEF). 1988. *Design of Municipal Wastewater Treatment Plants, Manual of Practice No. 8*. 4th Ed., Vol. 2. Alexandria, VA: WEF.
- Water Environment Research Foundation (WERF). 2002. *Best Practices for the Treatment of Wet Weather Wastewater Flows*. Prepared by Brashear, Robert, *et al.* WERF Project No.00-CTS-6. Alexandria, VA: Water Environment Foundation; London, United Kingdom: IWA Publishing.
- Wendle, Jeff, CTE Engineering Services. Interview about Lower Paxton Township, PA by Limno-Tech, Inc., August 2001. Ann Arbor, MI.

Inclusion of this technology description in this Report to Congress does not imply endorsement of this technology by EPA and does not suggest that this technology is appropriate in all situations. Use of this technology does not guarantee regulatory compliance. The technology description is solely informational in intent.



TECHNOLOGY DESCRIPTION

Treatment Technologies

Plant Modifications

Overview

Excess wet weather flows can cause sudden hydraulic surges and changes in pollutant loads that adversely affect the performance of wastewater treatment plants (WWTP). Excess wet weather flows can disrupt treatment processes and result in the discharge of untreated or partially treated sewage. As an alternative to constructing supplemental treatment units to handle excess wet weather flows, modifications of existing facilities may be sufficient to achieve the needed capacity and treatment efficiencies.

In general, these modifications involve either process control changes or physical reconfiguration of unit processes. Process control changes are operational; examples include the addition of chemicals to a clarifier to enhance settling and the modification of return sludge flow rates. Physical reconfiguration of unit processes involves actual modification of the internal components of a process. For example, a clarifier's internal components would be redesigned to improve its hydraulics and expand the range of flow and solids load it is able to handle. In addition to unit process modifications, system-wide or overall plant modifications can be used to improve performance with respect to treatment of excess wet weather flows; examples include flow distribution and real-time control.

A generalized schematic of a WWTP depicting typical unit processes and the associated sludge handling is shown in Figure 1. This technology description first describes unit process modifications and then overall plant modifications which can improve the ability of a WWTP to provide treatment for excess wet weather flows.

Unit Process Modifications

Clarification Processes

The performance of both primary and secondary clarifiers impacts the performance of biological secondary treatment units. The modifications described below pertain to both primary and secondary clarifiers, unless otherwise noted.

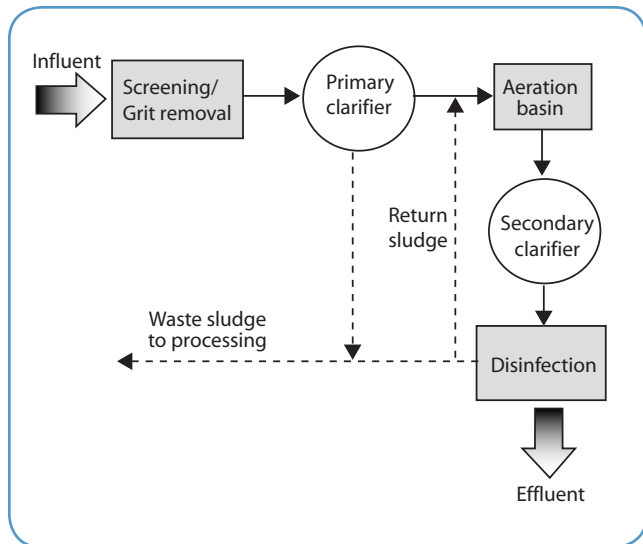

Figure 1. Schematic of a typical WWTP.

Chemical enhancement can improve solids removal in primary and secondary clarifiers. Two classes of chemicals used are coagulants and flocculants. Coagulants neutralize the charge associated with suspended solids in wastewater. This is important since most suspended solids in water are negatively charged and particles with the same charge repel each other. With the charges neutralized, the particles are able to stick together and form larger, heavier particles which settle faster. Flocculants (also referred to as coagulant aids) can help bridge and bind solids together, further increasing particle size, density, and settleability. Treatment plant operators may choose to use one or both types of chemicals depending on the wastewater characteristics, chemical costs, and other factors. Common coagulants include: aluminum sulfate (alum), polyaluminum chloride, ferric chloride, ferric sulfate, ferrous sulfate, calcium hydroxide carbonate (slaked lime), calcium oxide (quicklime), and sodium aluminate. The degree of clarification obtained when chemicals are added to untreated wastewater depends on the quantity of chemicals used, characteristics of the wastewater, and the care with which the process is

monitored and controlled. For any chemical application to be effective, the chemicals must adequately mix with the wastewater.

Baffles are most commonly used to interrupt or disperse density currents. Density currents travel at a higher velocity than surrounding waters and can carry solids through a clarifier and over its effluent weir, reducing effluent quality. The occurrence of density currents is also referred to as short-circuiting. These currents may exist in both circular and rectangular clarifiers, and may become more apparent and problematic during peak flows (NYSDEC 2001). Dye testing can be used to identify the existence of density currents and assist in determining the best baffle configuration. Baffles can be of any size and configured in multiple ways (e.g., placed in the top, middle, or bottom of the tank; constructed of one solid board or several boards with gaps in between). Various materials can be used to construct the baffle, including wood, fiberglass, plastic, and metal. In a rectangular clarifier, a baffle is a thin, vertical wall of material placed across the width of a clarifier. It may span up to the entire width and a portion of the depth of the clarifier. In a circular clarifier, baffles are commonly angled at 45-60 degrees along the perimeter of the clarifier wall, but they can also be placed perpendicular to the wall. Cross-section views of both placements in a circular clarifier are shown in Figure 2.

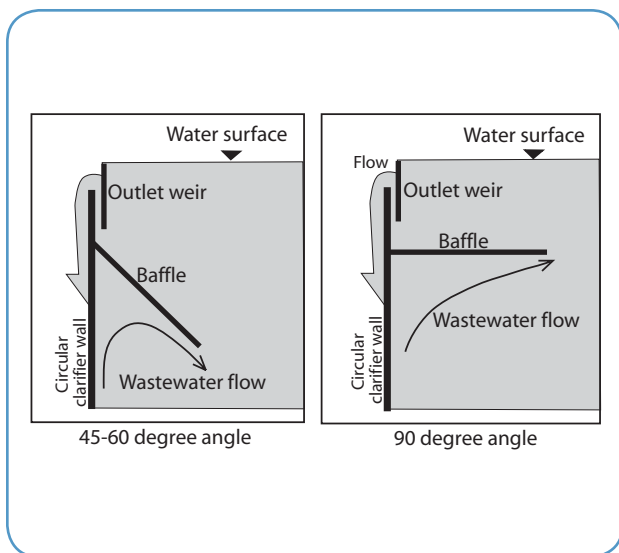

Figure 2. Example baffle replacement in circular clarifiers.

Lengthening weirs can reduce the loss of solids during periods of excess wet weather flow. For rectangular clarifiers, weirs can be lengthened by placing additional lateral weir troughs. In circular clarifiers with one peripheral effluent weir, weir lengths are normally

sufficient under average as well as peak flow conditions. For circular clarifiers with double-sided effluent weir troughs, eliminating identical V-notch spacing on outer and inner weirs can reduce solids loss during periods of excess wet weather flow. This can be accomplished by blocking alternating V-notches on the outer weir with plywood or other materials.

Biological Suspended Growth (Activated Sludge) Processes

Maintaining a concentration of biological solids in the activated sludge system higher than necessary for proper treatment will increase the potential for solids loss during peak flow periods. Operators should try to maintain the solids concentration that is necessary to ensure adequate treatment. The concentration of solids is managed primarily by controlling the total sludge mass in the system. Although long-term changes in total sludge mass must be made by adjusting the sludge wasting rate, short-term changes can be brought about by adjusting the return rate. Shifting the mode of operation to step feed or contact stabilization can be particularly effective, as described below.

Return sludge flow rate control is used to manage the sludge mass and detention time in the aeration basin of the activated sludge process. The return sludge flow is settled biomass that is removed from secondary clarifiers and recycled or returned back into the aeration basin (see Figure 1). It is necessary to return a portion of the secondary clarifier sludge to the aeration basin because the sludge contains the bacteria needed to maintain the biological treatment process. It is important to note that the rate at which the sludge is returned must be managed in accordance with influent conditions, sludge settling characteristics, and the dynamics of the biomass inventory which is continuously shifting between the clarifiers and the aeration basin. Understanding when to increase or decrease the return sludge flow can assist in maximizing secondary treatment capacity during periods of excess wet weather flow and improve effluent quality.

The step feed mode of operation introduces settled wastewater at several points in the aeration tank, as shown in Figure 3. Step feed mode can be used to handle increased organic loads by distributing them evenly across the aeration basin, but primarily provides more capability for handling hydraulic surges. To be effective, this approach generally requires three or more parallel channels in the aeration basin.

Contact stabilization is an operational modification in which the feed point is moved downstream in the

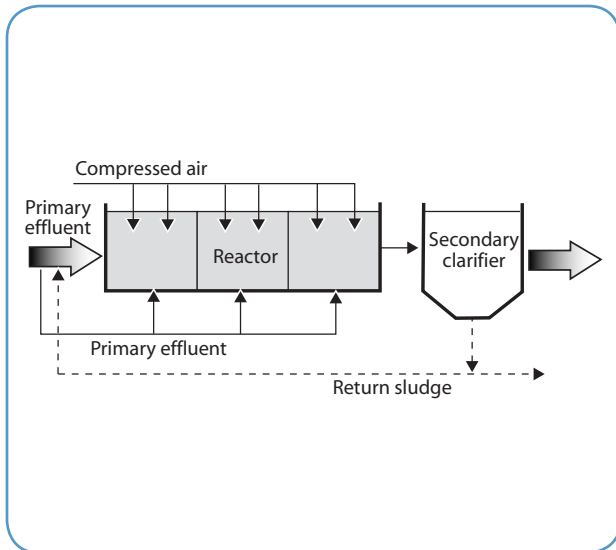

Figure 3. **Step feed mode of operation.**

aeration tank approximately one-half to two-thirds the length of the tank or into a separate tank. This configuration is shown in Figure 4. Return activated sludge is added to the basin inlet upstream of the feed point and aerated before being blended with influent. Similar to step feed, contact stabilization can reduce solids loss during hydraulic surge events. Solids in the reaeration basin are protected from the direct influent flow, thereby minimizing the potential for solids loss. Contact stabilization provides a relatively short detention time, which increases system stability.

Biological Fixed Film Processes

The biomass of fixed film processes, such as trickling filters and rotating biological contactors (RBCs), is not as easily washed out as the biomass of suspended growth processes. Nonetheless, their performance is impacted by excess wet weather flows. Techniques for improving the performance of fixed film processes under wet weather flow conditions are described below.

For trickling filters, recirculation of flow is commonly practiced to provide adequate wetting of the biological media. For RBCs, recirculation of sludge may be practiced to encourage some suspended growth and maintain dissolved oxygen and hydraulic loading. During peak flow periods, however, recirculation is generally not necessary and can be temporarily reduced or halted to allow increased capacity for peak flows.

Trickling filter flow distributors are used to spread wastewater influent evenly over the biological media. Distributor arms that are hydraulically driven may turn at excessive speeds during peak flow periods, but can be slowed by installing nozzles on the arms that discharge

in the opposite direction. The new nozzles can be capped to return the arm to normal speed during normal flow conditions. In practice, such changes are not made routinely.

Trickling filters are sometimes operated in series or sequentially. Pipes and pumping may be configured between units, however, such that during peak flow periods, the units could be converted to parallel operation allowing flows to pass through all filters simultaneously. This would increase the biological treatment capacity by reducing the hydraulic loading rate. Biochemical oxygen demand (BOD) removal efficiency may be reduced by placing the units in parallel operation; however, the reduced efficiency

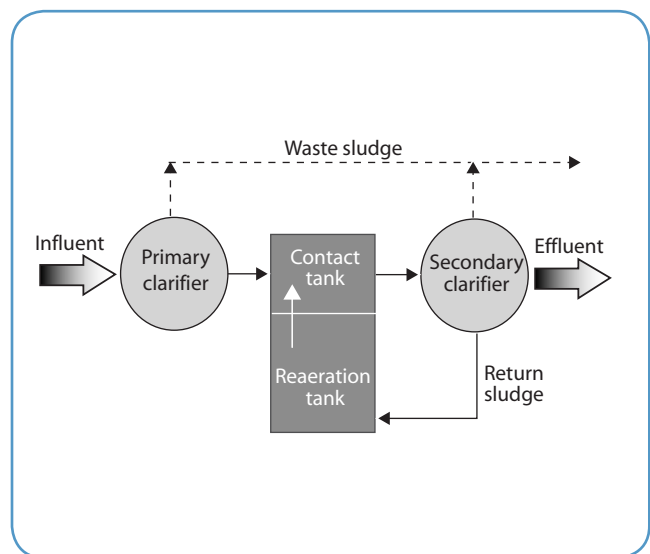

Figure 4. **Contact stabilizer mode of operation.**

would be offset somewhat by the fact that each unit will operate at or below design loading rates.

Chemical Disinfection Processes

During periods of excess wet weather flow, influent exposure time to chemical disinfectants may be insufficient for adequate disinfection. Key operational variables for optimizing performance of disinfection facilities include mixing and dosage. Poor disinfectant mixing or poor diffuser placement can significantly reduce effectiveness. For chlorine disinfection, it is possible to provide adequate disinfection at detention times of less than 15 minutes with the appropriate dosage (NYSDEC 2001). Determining the optimal dosage at high flows, however, requires some experimentation. Additional information on disinfecting wet weather flow is provided in the “Disinfection Technology Description” in Appendix

B of Report to Congress on the Impacts and Control of Combined Sewer Overflows and Sanitary Sewer Overflows.

Overall Plant Modifications

Flow Distribution and Control

Treatment facilities that have multiple treatment units used in a process must be able to control the distribution of flow. In general, uneven flow distribution can affect the hydraulic capacity in one or more of the treatment units, which can have a negative impact on performance (e.g., solids loss from a secondary clarifier) (NYSDEC 2001). Flow control can be incorporated into an existing facility through the addition of adjustable control weirs or appropriate valves.

Equal distribution of solids to the treatment processes, such as return sludge, is also important. Unless provided for in the design, equal distribution of solids to the treatment units may not occur coincidentally with the equal distribution of flow.

Sidestream Control

A sidestream is a liquid or sludge flow that is produced by a treatment process; wastewater treatment plants typically produce several sidestreams. Sidestreams are either handled separately from the wastewater flow, or returned to a specific unit process for additional treatment or to support operation. Controlling the timing and location of sidestream returns can prevent overload of the treatment facility. Specifically, consideration should be given to reducing or halting sidestream returns during peak wet weather flows (NYSDEC 2001).

Real-Time Automated and Remote Controls

Automated and remote operation controls, based on real-time system information, can improve preparation for and response to wet weather events. Real-time information from the sewer system can allow operators to anticipate the need for operational changes before excess wet weather flows reach the treatment facility, thereby optimizing the efficiency and effectiveness of mode shifts or operational changes. Additional information on the use of real-time control is provided in the “Monitoring and Real-Time Control Technology Description” in Appendix B of *Report to Congress on the Impacts and Control of Combined Sewer Overflows and Sanitary Sewer Overflows*.

At the treatment plant, automated or remote control systems optimize adjustments to gates, valves, and weir levels during wet weather events. Such real-time

controls have been shown to improve wet weather operations by reducing CSO events and maximizing sewer system storage capacity (Batzell 1994; Field *et al.* 2000). Real-time control within individual processes can also optimize unit process operation. For example, real-time information on dissolved oxygen concentrations in the aeration basin can optimize the performance of an activated sludge process.

Key Considerations

Applicability

A performance evaluation should be done prior to any plant modifications to determine whether it is feasible to obtain the needed capacity from the existing unit processes. Plant modifications are preferred over new construction since the cost of plant modifications is relatively small compared to new construction. Some of the recommended modifications for improving peak wet weather flow capacity, however, may result in increased effluent concentrations of BOD or other constituents. The ability to increase the capacity of existing processes must be balanced with the need to meet short- and long-term permit limits. In addition, modifications that require operator attention before and after a wet weather event may interrupt regular dry weather operations and potentially compromise the quality of treated effluent during dry weather.

Cost

In general, the costs for the modifications described above are low. Some modifications require only simple changes in operation and no additional treatment process units. Construction materials (e.g., lumber) for unit reconfiguration are typically simple and readily obtainable.

Material costs for density current baffles built in-house, for example, are quite low. In an article by the New York State Department of Environmental Conservation, the highest cost for a density current baffle reported was \$300 (NYSDEC 2002). Further, the addition of baffles can often be implemented by plant staff. Baffles commonly result in TSS reductions of 25-35 percent under average flow conditions and 40-50 percent under peak flow conditions (NEFCO 2002).

Of the potential modifications presented, chemical enhancement and real-time controls are expected to be the most expensive. Chemical enhancement represents an on-going cost that will vary depending on the chemicals used, and the frequency and volume of usage. Sludge volume and handling costs may also increase as a result of chemical addition. Nonetheless, chemical enhancement in primary

clarifiers has been demonstrated to improve TSS removal from the normal range of 50-70 percent to 80-90 percent.

Real-time control costs are summarized and presented in the *Monitoring and Real-Time Control Technology Description* in

Appendix B of the *Report to Congress on Impacts and Control of Combined Sewer Overflows and Sanitary Sewer Overflows*. Case studies for larger sewer systems indicated capital costs in millions of dollars. These systems represent highly sophisticated automated and predictive technology. Simpler

Implementation Examples

WASHINGTON COUNTY, NY

Responsible Agency: Washington County Sewer District #2

Population Served: 15,000

Service Area: 5.8 sq. mi.

Sewer System: 90 percent of combined sewer; 10 percent of sanitary sewer

Use of Contact Stabilization and Baffles

In March 1996, the NYSDEC and Washington County jointly conducted studies to investigate methods for increasing the wet weather treatment capacity of the existing secondary treatment process at the Sewer District #2 WWTP. The WWTP is an activated sludge facility designed to treat an average dry weather flow of 2.28 MGD. The actual dry weather flow averages 2.1 MGD. However, during wet weather, flow to the WWTP can exceed 15 MGD. Operators only allow 7.5 MGD to enter the plant in order to protect unit processes. Prior to the study, flow to the activated sludge process was further restricted to 5 MGD. During periods of wet weather, flows

entering the plant in excess of 5 MGD were bypassed around the activated sludge units and received only primary treatment and disinfection.

Two techniques for increasing secondary treatment capacity were investigated: operating the activated sludge process in contact stabilization mode; and evaluating primary and secondary clarifiers for short-circuiting. The studies found that the contact stabilization mode could treat a higher flow rate than conventional operation. Conventional operations failed to meet permit limits at flow rates greater than 7 MGD. The contact stabilization mode, however, was able to treat 7.5 MGD and meet permit limits.

Both the rectangular primary and circular secondary clarifiers exhibited short-circuiting. Baffle systems were designed for each, but installation was delayed for the secondary clarifier. The system initially installed in the primary clarifier was a seven-foot high, solid, mid-tank baffle that consisted of a used belt press supported by a wooden frame. The construction cost was less than \$50. After installation, testing showed no improvement in clarifier performance. The baffle was modified by cutting a six-inch opening every six inches. This configuration reduced the density currents and reduced effluent suspended solids by 10 percent (NYSDEC 2001). This also reduced the solids loading to the activated sludge process, improving overall treatment efficiency.

Contact: Joe McDowell, Washington County Sewer District

GRANVILLE, NY

Plant Modifications Increase Capacity

Responsible Agency: Village of Granville

Population Served: 2,646

Service Area: 1 sq. mi.

Sewer System: Not Available

The Village of Granville WWTP investigated methods for improving biological trickling filter and secondary clarifier performance during periods of wet weather. The WWTP experiences dramatic and prolonged peak flow events. Flows can rise quickly from a dry weather flow of 0.3 MGD to more than 3 MGD, and the elevated flows may last for up to a week. During periods of wet weather, the trickling filter distributor arm speed would increase and result in sloughing of biomass from the

filter media. Effluent quality was often degraded for a period of time beyond the wet weather event, as much of the biomass necessary for treatment was washed out.

During periods of high flow, the arm speed would increase from two revolutions per minute to more than seven revolutions per minute. Two retro nozzles (pointing in the opposite direction of existing nozzles) were installed on each trickling filter arm. The retro nozzles successfully slowed the arm speed to less than three revolutions per minute during periods of excess wet weather flow (greater than 2 MGD) (NYSDEC 2001). Excess sloughing and loss of biomass was reduced, resulting in higher effluent quality.

Suspended solids removal was problematic in the rectangular secondary clarifiers during both dry and wet weather periods. Extensive dye testing was conducted, and baffles were designed and installed. The initial baffle was installed at the one-third point in the tank. The baffle was solid at the top with staggered 2 x 8 lumber at the bottom. Dye test results after installation showed a 6 percent reduction in effluent solids. An additional baffle was designed and installed at the two-thirds point of the clarifier. This baffle was solid from top to bottom, but left a 14-inch opening at the bottom of the tank and a smaller area for flow at the top. With the second baffle, effluent solids concentrations were reduced by 19 percent (NYSDEC 2001).

Contact: Dan Williams, Village of Granville

CLATSKANIE, OR

Contact Stabilization Used for Treatment

Responsible Agency: Clatskanie People's Utility District

Population Served: 4,300

Service Area: 3.5 sq. mi.

Sewer System: Not Available

The Clatskanie WWTP is an activated sludge treatment facility that underwent a two-year full-scale performance evaluation of its wet weather treatment capabilities. High inflow and infiltration in its separate sanitary sewers resulted in the delivery of excess wet weather flows. During the evaluation, the plant was operated in the conventional mode during dry weather conditions. The average dry weather flow was 0.2 MGD and the peak dry weather flow was 0.5 MGD. During wet

weather flows, the activated sludge process was operated in contact stabilization mode. By switching operational modes during wet weather conditions, six to 12 times the average dry weather flow rate (approximately 1.25-2.3 MGD) was treated. For flows of up to 1.25 MGD, the mean suspended solids and BOD₅ effluent concentrations ranged from 2-24 mg/L and 6-11 mg/L, respectively. Removal efficiencies for wet weather flows ranging from 0.5-2.3 MGD were 71 percent and 73 percent for suspended solids and BOD₅, respectively (Benedict and Roelfs 1981).

References

Batzell, Russell W. 1994. "Computer Control of CSOs," *Civil Engineering*. Vol 64 (No.11): 58-59.

Benedict, A.H. and Roelfs, V.L. 1981. *Joint Dry/Wet Weather Treatment of Municipal Wastewater at Clatskanie, Oregon*. EPA-600/2-81-061, NTIS PB 81-187262.

Field, R., Villeneuve, E., and Stinson, M. K. 2000. "Get Real!" *Water Environment & Technology*. Vol 12 (No. 4): 64-68.

NEFCO, Inc. 2002. "Baffle Basics...A Brief Tutorial." Retrieved December 30, 2002.
<http://www.nefcoinc.com/torial.html>.

New York State Department of Environmental Conservation (NYSDEC). 2001. "Wet Weather Operating Practices for POTWs with Combined Sewers." Retrieved June 26, 2003.
http://www.dec.state.ny.us/website/dow/bwcp/ww_training.pdf

NYSDEC. 2002. "Clarifier Baffles Work." Retrieved December 30, 2002.
http://www.dec.state.ny.us/website/dow/bwcp/tt_baffles.pdf

Inclusion of this technology description in this Report to Congress does not imply endorsement of this technology by EPA and does not suggest that this technology is appropriate in all situations. Use of this technology does not guarantee regulatory compliance. The technology description is solely informational in intent.



TECHNOLOGY DESCRIPTION

Treatment Technologies

Disinfection

Overview

Disinfection of wastewater is necessary for the protection of public health. Therefore, municipal wastewater treatment processes are typically followed by a disinfection process that is designed specifically to inactivate bacteria, viruses, and other pathogens in the treated wastewater. The application of disinfection to CSOs and SSOs has been more limited, however, owing to uncertainties in process design, performance, and regulatory requirements. This technology description describes two processes that have been used to treat wet weather CSOs and SSOs: chlorine disinfection and ultraviolet (UV) light. Other technologies that have had more limited application in disinfecting CSOs and SSOs include ozonation, chlorine dioxide, peracetic acid, and electron beam irradiation. These will not be discussed in this fact sheet; more information is available in EPA's "Alternative Disinfection Methods" fact sheet (EPA 832-F-99-033).

Chlorine Disinfection

Chlorine disinfection involves the application of chlorine to wastewater to inactivate microorganisms. Wastewater disinfection most often employs gaseous chlorine. The gas is usually supplied in either 150-pound or 1-ton cylinders. When added to wastewater, gaseous chlorine undergoes hydrolysis and forms a mixture of hypochlorous acid (HOCl) and hydrochloric acid (HCl); some of the HOCl further dissociates to hypochlorite ion (OCl⁻). Hypochlorous acid and hypochlorite ion provide the majority of the disinfection. When ammonia is present, chloramines are also formed, although they are less potent as disinfectants.

Chlorine can also be applied in hypochlorite form. The chemistry of hypochlorination is very similar to gaseous chlorine in that the main agents of disinfection are hypochlorous acid and, to a lesser extent, hypochlorite ion. The two most commonly used hypochlorites are sodium hypochlorite, a clear, yellow

liquid, and calcium hypochlorite, a dry solid that comes in powder, granular, or tablet form.

Sodium hypochlorite, also known as bleach, is available in strengths ranging from 1-16 percent, but typically contains 12.5 percent available chlorine. Solutions of less than one percent strength can be generated electrochemically from salt brine solution, but must be done on-site. Calcium hypochlorite is a solid that contains 65-70 percent available chlorine. It is commonly used in tablet erosion systems, which pass a stream of water over the tablets and generate a solution of generally less than one percent available chlorine.

The performance of a chlorine disinfection system can be characterized in terms of the product of the chlorine concentration in milligrams per liter (mg/L) and the contact time in minutes, usually referred to as "CT." Disinfection efficiencies are usually fairly consistent for a given CT, and increase in proportion to increasing CT. Decreased contact time can therefore be offset by increased disinfectant concentration and vice versa.

Ultraviolet Light

Ultraviolet (UV) light disinfection involves the direct exposure of the wastewater stream to UV light, which alters genetic material in microbial cells and prevents them from reproducing. Germicidal wavelengths range from 200-320 nanometers (nm), with peak effectiveness at approximately 260 nm. In UV disinfection systems, a relatively thin film of wastewater flows past the UV lamps, and for a few seconds, the microorganisms are exposed to a dosage of UV energy.

Ultraviolet radiation is generated by striking an electric arc through mercury vapor contained in a lamp. Because ordinary glass absorbs UV light, the lamp is made of special UV light transmitting quartz, polymer, or silica. Factors that influence the level of radiation emitted from UV lamps include mercury vapor

pressure, chemical composition of the quartz sleeve, and electrical power input (Acher *et al.* 1997).

Low-pressure, low-intensity lamps have found the greatest application in disinfection of wastewater treatment plant effluents, primarily because they emit around 85 percent of their UV output at 254 nm, which is close to the most effective germicidal wavelength of around 260 nm. Due to their low-intensity, however, the number of lamps required is relatively large, which makes them impractical for high-rate applications such as disinfecting CSOs and SSOs. There is effectively no economy of scale in UV disinfection; much of the capital and operating costs are directly proportional to the number of bulbs, and the number of bulbs is directly proportional to the flow being disinfected. Medium-pressure, high-intensity lamps are becoming more widely available and have been shown to be more effective on lower-quality wastewaters such as CSO and SSO discharges. In addition, higher intensity means that fewer bulbs are required, which makes these systems more economical for CSO and SSO applications.

Ultraviolet disinfection technologies fall into two categories: closed systems and open channel systems. Closed system contact units consist of UV lamps encased in quartz around which wastewater flows. Open channel systems consist of submerged UV lamps either vertically or horizontally suspended in an open channel. Both systems are typically modular in design and are applicable to a wide range of flows.

To achieve inactivation, UV radiation must be absorbed into the microorganism. Therefore, anything that prevents UV light from reaching the microorganism will decrease the disinfection efficiency. Other factors that have been determined to affect disinfection efficiency include (EPA 1999):

- Chemical and biological films that develop on the surface of UV lamps
- Dissolved organics and inorganics in the wastewater, especially iron
- Clumping or aggregation of microorganisms
- Turbidity
- Color
- Incomplete exposure of wastewater to UV light

The effectiveness of UV disinfection is typically characterized by the UV dose. The dose is most often expressed in milliwatt-seconds per square centimeter ($\text{mW}\cdot\text{s}/\text{cm}^2$), and is defined as the product of the average intensity of UV energy emitted by the lamps (in mW/cm^2) and the exposure time (in seconds). UV dose

is analogous to the CT concept used to characterize chlorine disinfection and is of similar use in comparing results from studies.

Key Considerations

Applicability

Chlorine Disinfection

Chlorine is a fairly stable disinfectant that provides continuous disinfection. Chlorine disinfection often has significant space requirements; large tanks are usually required to allow for sufficient contact time between the chlorine and the wastewater. Chemical storage and the location of feed equipment must also be considered.

Chlorine reacts quickly with many constituents of wastewater including, but not limited to, pathogens, such that not all of the chlorine added is available for disinfection. The difference between the amount added and the residual concentration (that is, the concentration that persists long enough to provide disinfection) is called the “chlorine demand” (White 1999). The initial chlorine demand of the wastewater must be known to some extent so that enough chlorine can be added to satisfy initial demand and still provide a sufficient residual concentration.

Chlorine disinfection leaves residual chlorine in the treated wastewater, which is highly toxic to aquatic organisms. In addition, it may react with organics and inorganics in wastewater to form toxic compounds that can have long-term adverse effects on the receiving waters. For these reasons, residual chlorine levels are sometimes restricted by a facility’s discharge permit, and must be reduced by dechlorination. Dechlorination is typically done with either sulfur dioxide (a gas) or sodium bisulfite (a liquid).

Another effect of the chlorine disinfection process is the formation of disinfection by-products (DBPs), specifically halogenated organics such as total trihalomethanes (THMs) and haloacetic acids. DBPs form when natural organic matter reacts with free chlorine added for disinfection or free bromine that results from the chlorine disinfectant oxidizing bromide ions in the wastewater. DBP formation is affected by the type and concentration of natural organic matter, chlorine form and dose, time, bromide ion concentration, pH, organic nitrogen concentration, and temperature. The utility of chlorine for disinfection may be limited where DBPs are subject to regulatory limits. Removal of DBP precursors, modification of the

chlorine disinfection strategy, or changing disinfectants are typically used to lessen DBP formation.

UV Disinfection

UV disinfection requires no chemical storage and is very stable in this sense. Space requirements are relatively small due to short wastewater contact times and the lack of chemical storage.

Power consumption is an important consideration in UV applications. The process is energy-intensive compared to chemical methods. High-flow situations present high power demands, and will usually require an on-site generator, adding to the total construction and operating cost.

Advantages

Chlorine Disinfection

The primary advantage of gaseous chlorine is its low cost in relation to its overall effectiveness as a disinfectant. The technology is well-developed and straightforward to apply, and the chemical itself is widely available.

Hypochlorination acts in a similar fashion as gaseous chlorine and shares most of its advantages and disadvantages. It provides reliable inactivation of bacteria, it is widely available, and the technology is fully developed. Liquid sodium hypochlorite is usually somewhat more expensive than gas per pound of available chlorine.

UV Disinfection

UV disinfection is attractive for disinfection of CSOs and SSOs for several reasons. The disinfection process requires much shorter detention times than chemical methods, on the order of seconds as compared to 10 minutes or greater for chlorine. There are also no chemicals to transport, handle, or store, which appeases numerous concerns, including worker and public safety, environmental impacts, and degradation of chemical strength during storage. UV also does not form any known, potentially toxic byproducts, nor does it leave any toxic residuals.

Disadvantages

Chlorine Disinfection

Disadvantages of gaseous chlorine include poor inactivation of viruses and protozoan cysts and oocysts relative to bacteria, the formation of DBPs, and reactions with ammonia that result in combined chlorine residuals that are less effective disinfectants. These issues are especially important when treating CSOs and SSOs, since in many cases suspended solids

and ammonia levels are elevated in these flows. In addition, the hazards posed by leaking chlorine gas may make it infeasible for use at satellite locations, which could be in heavily populated areas. Fire and building codes may require scrubbers or other equipment to mitigate leaks.

Hypochlorination shares some disadvantages with gaseous chlorine, including lesser inactivation of viruses and protozoa, the formation of DBPs, and reactions with ammonia that lessen its effectiveness at a given residual concentration. Although liquid sodium hypochlorite is highly corrosive and must be handled with care, it is generally considered to pose less of a safety hazard than gaseous chlorine.

Solutions of sodium hypochlorite will decay in strength over time, especially at higher concentrations and temperatures. This can be a significant disadvantage for CSO and SSO facilities that are operated infrequently and which would require chemicals to be stored for potentially long periods of time. Decay rates can be attenuated by diluting the hypochlorite after delivery to 10 percent or even 5 percent, although this requires additional storage facilities. Calcium hypochlorite, used in tablet erosion systems, has a much longer shelf life than liquid sodium hypochlorite. Tablet erosion systems, however, may not be able to provide large enough volumes of chlorine solution with the short notice given by CSOs and SSOs during many wet weather events.

UV Disinfection

A major disadvantage of UV light disinfection of CSOs and SSOs has been its sensitivity to wastewater quality. Its efficiency is reduced by increased suspended solids and turbidity. The buildup of mineral deposits on the lamp sleeves also reduces effectiveness by reducing the applied dose of UV light. Recent advances are addressing these issues, however, by using higher intensity lamps and more effective self-cleaning mechanisms.

Cost

Chlorine Disinfection

Table 1 summarizes fecal coliform data for two chlorine disinfection facilities (more information on these facilities is provided in the case studies below): Washington, D.C., and Acacia Park in Oakland County, MI. The Washington, D.C., Northeast Boundary Swirl Facility (NEBSF) also tests for enterococci, and these results are also shown in Table 1. Samples at NEBSF are taken both in the disinfection chamber and at the river outfall.

The table shows the variability of performance that is often the case when treating CSOs and SSOs. A major operational issue is optimizing the addition of chlorine; the experience at these facilities and others has been that inadequate pathogen reduction is usually the result of insufficient chlorine levels. Achieving the desired chlorine level requires reliable flow measurement and knowledge of the strength of the chlorine solution.

Capital costs for construction of chlorine disinfection facilities are usually proportional to the peak design flow. The majority of the cost is in the construction of a basin that provides sufficient contact time (for example, 15 minutes); a smaller portion consists of equipment, such as feed pumps, mixers, and storage tanks. Analysis of construction costs of CSO detention and treatment facilities in the River Rouge area in southeast Michigan showed that the equipment portion of the chlorine disinfection costs were approximately three to four percent of the total project cost (Tetra Tech MPS 2002). These facilities generally included significant storage volume beyond what would be needed solely for chlorine disinfection, however. If the basin costs are adjusted to provide a 15-minute detention time, the costs for the facilities average around \$14,000 per MGD of peak flow. Reducing the detention time to 10 minutes, which is feasible if highly efficient chemical

mixing is provided, reduces this cost to about \$9,500 per MGD. Actual construction costs vary considerably because of site-specific conditions.

Ultraviolet Light

UV systems do not have as long a record as chlorine disinfection facilities in disinfecting CSOs and SSOs. Pilot studies have shown, however, that fecal coliform levels of 1,000 #/100 mL can be met consistently by medium-pressure, high-intensity units operating within their normal range of power usage (CDM 1997; Curtis and Blue 1999). In another study, *E. coli* levels of 126 #/100 mL were met by both low- and medium-pressure systems treating effluent from a physical/chemical process using alum as the coagulant (Matson *et al.* 2002). The desired *E. coli* level was not met when ferric chloride was used, however.

Capital costs for construction of UV disinfection facilities are not well known, due to a lack of data for this relatively new technology. As part of a CSO disinfection pilot study, capital costs for construction of UV disinfection facilities were projected by the US EPA Office of Research and Development. In this study, it is estimated that a UV disinfection facility that results in a four-log reduction in fecal coliform with a peak flow of 88 MGD will cost approximately \$27,600 per MGD of peak flow (EPA 2002).

Table 1. Pathogen removal performance for chlorine disinfection facilities.

Period	Number of Samples	Geometric Mean Fecal Coliform (#/100 mL)			Geometric Mean Enterococci (#/100mL)	
		Acacia Park	NEBSF		NEBSF	
			Disinfection Chamber	River	Disinfection Chamber	River
1997	13	5.4	--	--	--	--
1998	57	2,220	--	--	--	--
1999	31	2,430	--	--	--	--
Jan-Mar 2001	--	--	2,240	9,230	68	496
Apr-Jun 2001	--	--	6,620	26,500	1,700	23,800
Jul-Aug 2001	--	--	1,600	8,940	593	7,080

Implementation Examples

WASHINGTON, DC

Responsible Agency: District of Columbia Water and Sewer Authority

Population Served: 572,000

Service Area: 19.50 sq. mi.

Sewer System: 1,800 mi. of sanitary and combined sewer

Northeast Boundary Swirl Facility (NEBSF)

The District of Columbia Water and Sewer Authority (WASA) operates a sewer system that includes combined sewers serving approximately 12,478 acres. Among its existing CSO controls is the NEBSF, which provides treatment and disinfection for up to 400 MGD of CSO before discharging to the Anacostia River. The facility provides mechanical screening followed by three 57 foot diameter swirl concentrators. The effluent from the swirl concentrators flows to a mixing chamber where sodium hypochlorite is added, usually at a dose

of 5 mg/L. Sodium bisulfite is added at the end of the outfall for dechlorination, usually at a dose of 2 mg/L. Flows above 400 MGD receive no treatment and are discharged through the same outfall as treated flows.

Samples taken during CSO events at the mixing chamber and at the river outfall are analyzed for enterococcus and fecal coliform. Reported counts range from less than 10 MPN/100 mL to in excess of 250,000 MPN/100 mL. The high numbers are associated with events in excess of 400 MGD and represent a comingling of treated and untreated CSO.

Annual operating costs for the NEBSF are estimated to be about \$230,000. This is based on \$180,000 for labor and \$50,000 for chemicals. Labor includes two full-time operators, a part-time supervisor, and other part-time support for cleaning and maintenance. The facility discharges on average about 100 times per year, with an average total volume of approximately 1,500 MG.

Contact: Mohsin Siddique, CSO Control Program Manager, DC WASA

BIRMINGHAM, AL

Responsible Agency: Jefferson County Environmental Services Division

Population Served: 376,000

Service Area: Not Available

Sewer System: 3,100 mi. of sewer

UV Disinfection at Peak Flow WWTP

The Jefferson County Environmental Services Division owns and operates nine wastewater treatment facilities, collecting and treating wastewater from the City of Birmingham and some 20 neighboring municipalities. These nine plants, along with about 658 miles of separate sewers, serve an approximate population of 376,000 at an average daily flow of 97 MGD. The Village Creek WWTP has at times received peak flows greater than ten times its annual average flow (in excess of 400 MGD versus an average of 40 MGD). Currently, a 350 MGD peak excess flow treatment facility is under construction.

The Village Creek Peak Flow Wastewater Treatment Plant (PFWWTP) includes a pump station with 360 MGD capacity, 20 surge basins with surface aeration for mixing (total capacity of 90 MG), granular monomedia deep bed filters with 350 MGD capacity, UV disinfection, and a 24-megawatt generating facility (primarily to power the pump station and UV). The entire facility is scheduled to be completed in the summer of 2003.

The Village Creek PFWWTP uses a UV disinfection system with a total of 2,688 lamps and has a peak power requirement of 7,526 kW. The total installed cost of the UV facility at Village Creek is estimated to be \$13 million; the cost for the UV equipment is approximately \$10.7 million. Operating costs are not available.

Contact: Harry Chandler, Assistant Director, Environmental Services, Jefferson County

OAKLAND COUNTY, MI

Responsible Agency: Oakland County Drain Commissioner

Population Served: 4,500

Service Area: 1.28 sq. mi.

Sewer System: Not Available

Chlorine Disinfection at Acacia Park

The Office of the Oakland County Drain Commissioner (OCDC) currently operates three CSO retention basins in southeastern Michigan, all of which provide treatment and disinfection of flows that exceed their storage capacity. The Acacia Park CSO Retention Treatment Basin (RTB) is a 4 MG basin that serves a combined area of approximately 816 acres. Disinfection is by sodium hypochlorite, which is stored at about 6 percent to reduce the rate of degradation during storage. The feed system

is designed to provide a dose of 10 mg/L at a CSO flow rate of 426 MGD. The hypochlorite is fed at the discharge of the influent pumps, which provides sufficient mixing. Dechlorination is not currently provided at this facility.

Extensive monitoring of the basin performance was conducted during a three-year demonstration period from 1997-1999 (Johnson *et al.* 2000). The disinfection target was a fecal coliform count of less than 400 #/100 mL at a total residual chlorine (TRC) level of 1.0 mg/L. The purpose of the TRC goal is to ensure that a sufficient dose of chlorine is delivered to the basin.

Five of the nine events monitored had average TRC levels above 1.0 mg/L, and the fecal coliform target was met in four of these five events. The four events with average TRC levels less than 1.0 mg/L did not meet the fecal coliform target. Low TRC was generally attributed to sodium hypochlorite solutions being weaker than anticipated either because of degradation or inaccurate dilution of the chemical.

Annual operating costs for the Acacia Park facility are estimated to be \$120,000. This includes \$58,600 for labor, \$24,800 for energy and utilities, \$26,000 for chemicals, and \$10,500 for laboratory and other services. These costs reflect some additional expense associated with startup, testing, and performance evaluation. Over the three-year demonstration period, the facility captured approximately 60 percent of the flow it received; that is, treated overflows represented 40 percent of flow into the facility. The total volume of flow into the facility was estimated at 146 MG, with 88 MG retained and returned to the sewer system and 58 MG treated and discharged. Overflows occurred on average four to five times per year, and ranged in volume from 0.13-17 MG.

Contact: Dan Mitchell, Hubbell, Roth, and Clark, Michigan

BREMERTON, WA

Responsible Agency: City of Bremerton

Population Served: 40,000

Service Area: 10 sq. mi.

Sewer System: 250 mi. of sewer

UV Disinfection at CSO Treatment Facility

The City of Bremerton has recently constructed a CSO treatment facility that uses high-rate clarification, followed by UV disinfection, to treat flows up to 45 MGD. The facility uses a medium-pressure, high-intensity UV system that employs a total of 90 bulbs. A 500 kilowatt generator is located on site to supply power to the UV system as well as pumps, mixers, and other appurtenances.

The clarification system uses a polyaluminum chloride coagulant, which was selected over the equally effective ferric chloride to avoid UV interferences by residual iron. The primary reason for choosing UV over chlorination was to avoid the degradation of hypochlorite between discharge events, which are estimated to occur approximately 20 times per year. Bremerton installed a UV system at a cost of about \$600,000 to disinfect CSO discharges. The annual operation cost for the entire facility is estimated to be about \$50,000; UV power costs and bulb replacement are a portion of this.

Contact: John Poppe, Wastewater Division Manager, City of Bremerton

COLUMBUS, GA

Chlorine and UV Disinfection Demonstration Project

Responsible Agency: Columbus Water Works

Population Served: 186,000

Service Area: 95 sq. mi.

Sewer System: 8.1 mi. of combined sewer

Columbus Water Works (CWW) operates a sewer system and treatment plant that includes 5,200 acres of combined sewer service area. Pilot studies aimed at gathering more information for controlling CWW's CSOs grew, in part with the aid of an appropriation from Congress, into the Uptown Park Advanced Demonstration Facility (ADF). The ADF included vortex separators, compressed media filtration, and chemical and UV disinfection systems. Chemicals evaluated included sodium hypochlorite, chlorine dioxide and peracetic acid; vortex separators were used as contact chambers

for chemical disinfection. The UV system used medium pressure, high-intensity lamps.

The study demonstrated the challenges to chemical disinfection posed by the variation of chemical oxidant demand in CSO. In general, no direct relationships were observed between effluent fecal coliform concentrations and CT values based on disinfectant dose alone. Useful relationships were obtained, however, when CT values were normalized by both CSO ammonia concentration and the mass of chemical oxygen demand (COD) removed. The results were used to develop control algorithms for disinfectant dosing that are based on CSO influent conditions, rather than relying on residual chlorine measurements that can be difficult to obtain reliably under rapidly changing flow conditions.

UV disinfection performance was characterized by the inactivation of *E. coli*. The inactivation increased with increasing UV dose, which was calculated as the product of applied lamp power, UV percent transmittance, and contact time. UV transmittance of the filtered effluent was typically less than 60 percent, and at levels less than 40 percent, effluent bacteria increased by an order of magnitude (from hundreds to thousands). In contrast, the unfiltered CSO UV transmittance was as low as 20 percent.

Capital and operating costs were developed for an optimized treatment train consisting of screening and grit removal, vortex separation, filtration, and combined chemical and UV disinfection. UV and chlorine disinfection/dechlorination accounted for about 28 percent of the capital cost and 39 percent of the operating cost. Capital costs for a treatment system designed for 63 percent removal of TSS were estimated to be approximately \$10,000 per acre of combined sewer service area; annual operating costs were estimated to be about \$163 per acre. Designing the system for 80 percent removal of TSS increased the capital cost nearly threefold, with annual operating costs doubling.

Contact: Cliff Arnett, Columbus Water Works

References

Acher, A., *et al.* 1997. "Ecologically Friendly Wastewater Disinfection Techniques." *Water Research*. 31(6):1398-1404.

Camp, Dresser & McKee (CDM). 1997. "Spring Creek AWPCP Upgrade - CSO Disinfection Pilot Study - Final Report." Location: Publisher.

Curtis, M. and K. Blue. *City of Unalaska Ultraviolet Disinfection of a Primary Effluent*. Conference proceedings at Water Environment Federation WEFTEC New Orleans, LA, 1999.

EPA Office of Research and Development. 2002. CSO Disinfection Pilot Study: Spring Creek CSO Storage Facility Upgrade. EPA 600-R-04-077.

EPA Office of Water and Office of Ground Water and Drinking Water. 1999. *Alternative Disinfectants and Oxidants Guidance Manual*. EPA 815-R-98-009.

Johnson, C. E., *et al.* *Operating Experience with Large CSO Control Facilities*. Conference proceedings at Water Environment Federation WEFTEC Anaheim, CA, 2000.

Matson, B., *et al.* *Meeting SSO Requirements with a High Rate Process Train: Pilot Results Lead the Way*. Conference proceedings at Water Environment Federation WEFTEC Chicago, IL 2002.

Poppe, John. Wastewater Division Manager, City of Bremerton, WA. Interview by Limno-Tech, Inc., December 2002. Ann Arbor, MI.

Siddique, Mohsin. CSO Control Program Manager, District of Columbia Water and Sewer Authority. Interview by Limno-Tech, Inc, December 2002. Ann Arbor, MI.

Tetra Tech MPS. Interview by Limno-Tech, Inc., December 2002. Ann Arbor, MI.

White, G.C. 1999. *Handbook of Chlorination and Alternative Disinfectants*. 4th Ed. New York: Wiley and Sons, Inc.

Inclusion of this technology description in this Report to Congress does not imply endorsement of this technology by EPA and does not suggest that this technology is appropriate in all situations. Use of this technology does not guarantee regulatory compliance. The technology description is solely informational in intent.



Vortex Separators

Overview

Vortex separators are designed to concentrate and remove suspended solids and floatables from wastewater or storm water. Sometimes referred to as swirl concentrators, vortex separators use centripetal force, inertia, and gravity to provide treatment. The vortex design induces solids to settle out into a sump; floatables are captured by screens. In combined sewer systems (CSSs), vortex separators are used at hydraulic control points (regulators) to separate combined sewage into a small volume of concentrated sewage and solids, and a large volume of more dilute sewage and storm water runoff. The concentrated sewage is typically conveyed to a wastewater treatment plant (WWTP) for treatment, and the dilute mix is discharged directly to a receiving water. This discharge may or may not be disinfected. In storm water systems, vortex separators are used to capture solids and floatables at storm water outfalls. In storm water applications, captured material needs to be cleaned out and removed for disposal on a regular basis. In general, vortex separators are not used to provide treatment at remote locations in sanitary sewer systems (SSSs). The focus of this technology description is the use of vortex separators for controlling wet weather discharges from CSSs.

Vortex separators are flow-through structures that usually have one inlet and two outlets: one for concentrated sewage and solids, and one for more dilute sewage. Different vendors provide different design features to optimize liquid-solid separation and pollutant removal. Many vortex separators use screens and baffles to collect floatables. Floating sorbent materials are also used in some designs to capture oil and grease. The range of size and capacity of vortex separators is quite large.

A simple diagram of a vortex separator is shown in Figure 1. The basic operation of a vortex separator is as follows:

- Excess wet weather flow enters the separator tangentially through an inlet pipe.

- Velocity causes flow to move through the separator in a circular path, forming a vortex.
- Inertia, gravity, and centripetal forces cause the heavier solid particles to move to the center and bottom of the swirling flow. Clearer water rises and discharges through the outlet.
- The concentrated sewage, including heavier solids and debris, becomes underflow and is discharged through a foul sewer outlet at the bottom of the separator and routed to a WWTP.

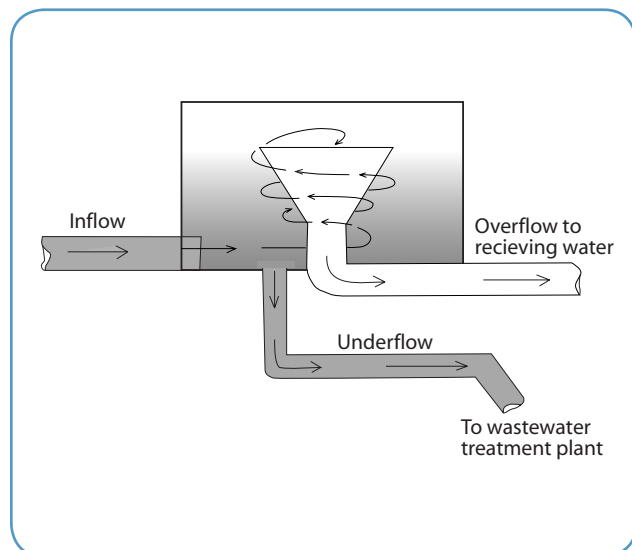

Figure 1. Simplified diagram of a vortex separator.

When the separator is full, the more dilute and clarified effluent is discharged through an overflow outlet at the top of the separator and conveyed to local receiving waters. At the end of an event, as excess wet weather flows subside and the water level in the separator drops below the level of the overflow outlet, the separator ceases to discharge to the receiving water.

Disinfection of the discharge from vortex separators is sometimes added for public health reasons (Boner *et al.* 1995). Sodium hypochlorite can be injected into

the separator basin, allowing the wet weather flows to be disinfected as the solids are removed. Chlorinated discharges may also need to be dechlorinated to prevent toxicity. Discharges from a vortex separator can also be treated using ultraviolet (UV) disinfection. If the separator design includes a sump to capture solids, the solids should be removed in advance of the next wet weather event. Some designs enable buoyant floatables to be skimmed from the dilute overflow and mixed with the underflow for conveyance to the treatment plant.

Key Considerations

Applicability

Vortex separators provide a modest level of treatment for a modest cost. In CSS, they can be used as a “stand-alone” CSO control, or in conjunction with other controls. When used on their own, they are useful in controlling suspended solids and floatables and in reducing pollutants associated with solids, such as metals bound to sediments. Their ability to reduce floatables in CSO discharges is valuable in situations where control of aesthetic impacts is important to the public. They have limited ability to reduce the strength of dissolved pollutants or bacteria unless disinfection is applied in conjunction with vortex separation. When used in combination with other CSO controls, the placement of vortex separators is important. Because they are designed to remove suspended solids and floatables, vortex separators should not be placed downstream of other facilities that perform the same function, such as sedimentation basins or netting systems.

Vortex separators are often retrofitted within CSSs to provide some level of treatment where none had existed before. Considerations in implementing vortex separators include:

- Vortex separators do not require a power source because the energy of the flowing water is used to separate the solids. Therefore, the utility of vortex separation technologies is diminished in situations where the velocity of wet weather flows is limited.
- Space requirements are minimal relative to storage units because they separate rather than store sewage.
- Units can range in diameter from 2 feet to more than 40 feet and are typically installed underground.
- Soil conditions and depth to bedrock at potential sites influence site suitability and construction costs.
- Vortex separators can be either pre-fabricated or built on-site. They can be constructed of concrete, high-density polyethylene (HDPE), aluminum, or stainless steel, depending on the manufacturer.

Advantages

The major advantage of vortex separators is their ability to remove suspended solids and floatables, which are the most visible and aesthetically displeasing components of CSO discharges. Vortex separators begin to separate out suspended solids and floatables as soon as inflow begins to move through the unit. Additional advantages include:

- Maintenance requirements are low. Vortex separators have no moving parts to wear out or break. They can be allowed to go dry between storms without affecting performance.
- Vortex separators have a high hydraulic loading capacity.
- Space requirements at implementation sites are low.

Disadvantages

The principal disadvantage in the use of vortex separators for CSO control is that they do not eliminate CSOs or reduce CSO volume; they just reduce the strength of the CSO discharge with respect to suspended solids, pollutants associated with suspended solids, and floatables. Other disadvantages include:

- Removal rates of fine solids and soluble pollutants are low or negligible in vortex separators.
- Disinfection is difficult because of the large volumes of excess wet weather flow received by vortex separators, short contact time for disinfection, and space and security requirements associated with disinfectants.
- Floatables may be lost during extremely high flows or in the initial overflow, when the surge of inflow could carry them around and over the baffles and weirs designed to remove them.
- Vortex separators with sumps require periodic cleaning to achieve optimal removal performance.

Cost

The performance of vortex separators with respect to pollutant removal is based on the difference in pollutant load, not volume, that is discharged to a receiving water over time, with and without a vortex separator. Performance is directly related to the nature of the solids and floatables in the influent wastewater, as well as the influent concentrations and loading rates. Qualitatively, vortex separators can be expected to provide “good” removal of heavier particles and floatables and “fair to poor” removal of lighter weight materials such as oil and grease, nutrients, and colloidal material (WERF 2002). Some common performance characteristics are as follows:

- Vortex separators perform better for concentrating larger or heavier suspended solids for treatment

than smaller or lighter suspended solids. Removal of dissolved solids or dissolved fractions of pollutants is negligible.

- Site specific design matched to particle size and settling velocity profiles of suspended solids is essential to optimize performance.
- Floatables capture decreases as hydraulic loading increases.

Available data for basic vortex separation suggest widely varying performance, with total suspended solids (TSS) removal ranging from five percent to 60 percent (EPA 1996; Boner *et. al.* 1995; WERF 2002). The higher removal rates are comparable to primary clarification, but can be achieved in a vortex separator that is one-fourth the volume and one-fifth the surface area of a conventional sedimentation basin (Boner *et. al.* 1995). TSS removal rates of up to 80 percent have been achieved when units are operated at one-fourth of the hydraulic capacity (Larry Walker Associates 1999). In a survey of vortex separator performance documented by Moffa (1997), removal efficiencies were shown to vary substantially from storm-to-storm, and from one facility to another.

Additional vortex separation performance information for other pollutants is as follows:

- BOD₅ removal rates have ranged from 20 percent and 79 percent in laboratory studies (Moffa 1997). Actual

BOD₅ removal rates for two storms in Columbus, GA, reached 55 percent (Boner *et. al.* 1995). Data for the Northeast Boundary Swirl Facility in Washington, D.C., indicate BOD₅ removal efficiencies of up to 28 percent (WERF 2002).

- Manufacturer laboratory tests show that vortex separators can remove 80 percent of oil and grease; however, no data are available for oil and grease removal rates under actual, full-scale operating conditions.
- UV disinfection of vortex discharges can achieve a 90-99 percent reduction in the concentration of fecal coliform bacteria (WERF 1994).

Costs for purchasing a basic vortex separator range from approximately \$8,000 for a 1.8 MGD unit to \$40,000 for a 16 MGD unit. Installation costs typically from 25-50 percent of the purchase costs (Larry Walker Associates 1999). A summary of products from various manufacturers with ranges in available hydraulic capacities and costs is presented in Table 1.

Maintenance costs for vortex separators vary depending on cleaning frequency, travel distances, and disposal costs for captured solids and floatables.

Table 1. Comparison of vortex separation products and costs.

Product (Manufacturer)	Available Hydraulic Capacity Sizes (MGD)	Purchase Costs
Continuous Deflective Separation (CDS Technologies)	0.7-193.8	\$9,600 - \$332,500
Downstream Defender (H. I. L. Technology, Inc.)	1.9-7.8	\$10,300 - \$26,000
V2B1 (Kistner Concrete)	1.8-16.3	\$8,000 - \$40,000
Vortechs Storm Water Treatment System (Vortechnics)	1.0-16.2	\$10,500 - \$40,000

Implementation Examples

RANDOLPH, VT

Responsible Agency: Burlington Main Wastewater Treatment Facility

Population Served: 37,712

Service Area: Not Available

Sewer System: 100 mi. of sewer

Vortex Separator Used to Treat CSOs

The Burlington Main Wastewater Treatment Facility (WTF) treats municipal wastewater from the city's CSS and discharges treated flow through an outfall into Lake Champlain. The WTF also has a CSO treatment system on-site which includes vortex separation, mechanical screening, and disinfection; the system was installed in the early 1990s. The CSO treatment system is designed to handle wet weather instantaneous flows greater than 11 MGD, but not exceeding 86 MGD.

The vortex separation process, combined with the capacity of the treatment plant, is designed to provide a relatively high level of treatment for the "first flush" generated during the early stages of storm events that usually contains the highest pollutant concentrations. Chemical disinfectant is added to the CSO flow prior to and after treatment by the vortex separator. The concentrated underflow from the vortex separator, approximately 2 MGD, is diverted to the WTF for full treatment. During wet weather events when the instantaneous storm flow rate exceeds 75 MGD, ultrasonic sensors allow flows to bypass the vortex separator. According to self-monitoring reports from January 1995 through December 1999, the CSO system was activated an average of 32 times per year, 13 times on average during the "beach season" of June through August.

More information at <http://www.dpw.ci.burlington.vt.us/>

COLUMBUS, GA

Responsible Agency: Columbus Water Works

Population Served: 186,000

Service Area: 2,400 sq. mi.

Sewer System: Not Available

National Demonstration Project

The Columbus CSS extends over the old downtown area draining into the Chattahoochee River. Prior to CSO control, elevated levels of fecal coliform bacteria and visible sewage debris often plagued the Chattahoochee. Columbus began to implement CSO controls in 1995, including construction of two water resource facilities (WRFs). One of the WRFs, in Uptown Park, also serves as a national CSO technology testing facility used to demonstrate and evaluate alternative methods of CSO pollutant removal and disinfection.

A five year CSO testing program was conducted at the Uptown WRF to analyze the performance, operation and maintenance (O&M), costs, and applications of CSO treatment technologies, including vortex separators. At this facility, Columbus installed six vortex separators, each 32 feet in diameter, with a conical ring bottom where grit and concentrated solids are removed. All six vortex vessels start empty and fill with CSO flow as CSS capacity is exceeded. The vessels have no moving parts. The vortex vessels serve as storage for small events, pollutant reduction during medium events, and grit removal and chemical disinfection for all events. Chemical disinfectant is added once the vortex vessels are full. For loading rates of 5 gallons per minute per square foot (gpm/sf) of surface area, the vortex separators functioned similar to a primary clarifier. For loading rates above 5 gpm/sf, however, the removal of pollutants was reduced to zero except for grit and oil and grease. The study also found that the use of vortex separators in combination with media filters was an effective treatment method in terms of load reduction and cost. The annual O&M for the vortex separators is estimated at \$16,320, which is about 7 percent of the total O&M costs at the Uptown Park WRF. The capital cost of the vortex separators was \$4.8 million.

Contact: Cliff Arnett, Columbus Water Works

References

Boner, M. C., *et al.* 1995. "Modified Vortex Separator and UV Disinfection for Combined Sewer Overflow Treatment." *Water Science Technology*. 31: 263-274.

EPA Office of Wastewater Management, Municipal Support Division and National Risk Management Research Laboratory (Cincinnati) Water Supply and Water Resources Division. 1996. *Assessment of Vortex Solids Separators for the Control and Treatment of Wet-Weather Flow*. EPA 832-B-96-006.

Larry Walker Associates, Inc. 1999. "Investigation of Structural Control Measures for New Development. Prepared for the Sacramento Storm water Management Program." Retrieved December 12, 2002.
www.sacstormwater.org/const/manuals/pdf/scm99_scm99.pdf

Moffa, P.E. (Ed.). 1997. *Control and Treatment of Combined Sewer Overflows*. 2nd ed. New York, NY: Van Nostrand Reinhold.

Water Environment Research Federation (WERF). 1994. *Optimization of Vortex Separator Removal Efficiencies for CSO Treatment*. Prepared by Boner, M. C., *et al.* Alexandria, VA: WERF. Project 92-TCR-2.

WERF. 2002. *Best Practices for Treatment of Wet Weather Wastewater Flows*. Prepared by Brashnear, R., *et al.* Alexandria, VA: WERF. Project 00-CTS-6.

Inclusion of this technology description in this Report to Congress does not imply endorsement of this technology by EPA and does not suggest that this technology is appropriate in all situations. Use of this technology does not guarantee regulatory compliance. The technology description is solely informational in intent.



Floatables Control

Overview

Solids and floatables are the trash, debris, and other visible materials that are discharged when sewers overflow. In sanitary sewer systems (SSSs), solids and floatables are generally limited to human waste and sanitary products that are flushed down a toilet. In combined sewers systems (CSSs), solids and floatables can also include litter and detritus that accumulates on streets and parking lots that are washed into storm drains during rainfall events. The presence of solids and floatables in receiving waters causes aesthetic impacts that can threaten wildlife, cause beach closures, and pollute recreational areas.

Floatables control technologies are principally applied in CSSs because of the recurring nature of CSOs. They are also used to control solids and floatables in urban storm water discharges from separate storm water systems. Floatables controls are most often designed to lessen aesthetic impacts that affect recreational uses. Water quality benefits from floatables controls, if they occur, are secondary. The CSO Control Policy recognized the importance of controlling solids and floatables by including it as part of the nine minimum controls. Floatables controls can be grouped into three categories:

- *Source controls* work to prevent solids and floatables from entering the sewer system.
- *Sewer system controls* work to keep solids and floatables in the sewer system, so that they can be collected and removed at strategic locations or transported to a wastewater treatment plant.
- *End-of-pipe controls* work to capture solids and floatables as they are discharged from the sewer system.

Source Controls

Source controls collect solids and floatables before they enter the sewer system. Two of the most common source controls are street sweeping and catch basin modifications. Street sweeping is a pollution prevention activity that removes litter, debris, dirt, and other

floatables materials from streets and other paved surfaces before it can be washed into a CSS during wet weather events. Paved surfaces can be swept using manual, mechanical, or vacuum sweepers (WEF 1999). The degree of floatables control achieved by street sweeping is influenced by the frequency of cleanings, local climate, and parked vehicle control (EPA 1999b).

Catch basins are the surface-level wells or chambers that serve as an entrance to CSSs and separate storm water systems for street runoff and overland flow. Catch basins are designed to trap grit and solids before they enter the sewer system (Moffa 1997). There are several modifications that can be made to catch basins to improve the capture of solids and floatables. Inlet grates installed at the entrance to the catch basin can reduce the amount of street litter and debris that enters the catch basin. If floatables enter the basin through these grates, they can be collected in colander-like structures called trash buckets installed beneath the grate. Other catch basin modifications, such as hoods and submerged outlets (Figure 1), modify the connection between the catch basin and the CSS to trap floatables

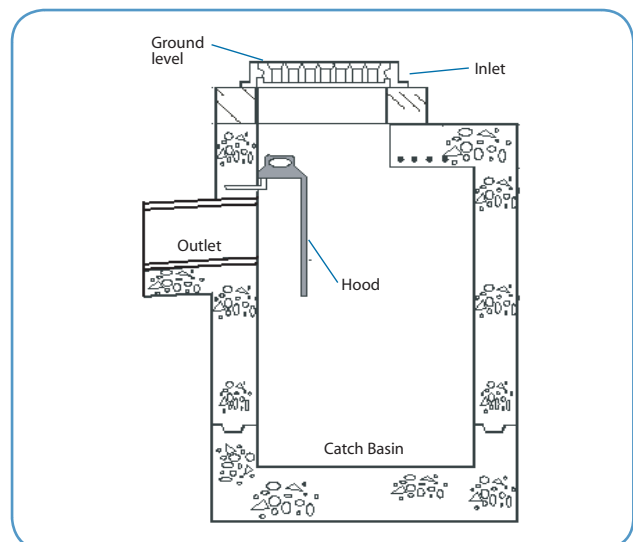

Figure 1. Typical hood design in a catch basin.

in the catch basin. Submerged outlets are located below the elevation of the sewer system and are connected by a riser pipe. Hoods are vertical cast iron baffles installed over the outlet pipe in the catch basin.

Collection System Controls

Collection system controls are designed to keep solids and floatables in the sewer system so that they can be collected and removed at strategic locations or transported to a wastewater treatment plant. Screens, baffles, and in-system netting are types of collection system controls.

Screens can be installed near CSO outfalls or at other strategic locations in the CSS. Screens trap floatables behind metal bars or mesh, allowing wastewater to pass through. Screen openings typically range in size from 0.1 inch to 6 inches. The type of screen and size of openings determine the amount and size of floatables captured (EPA 1999c). Major categories of screens include:

- Bar screens or trash racks with openings greater than 1 inch;
- Coarse screens with 0.25-1 inch openings; and
- Fine screens with 0.001-0.25 inch openings.

The nature and quantity of floatables in wet weather flows makes them likely to clog fine screens therefore their utility may be limited. Screens are usually set 0-30 degrees from vertical and may be cleaned manually or mechanically.

Baffles can be installed at flow regulators in CSSs or at outlets from storage facilities. Baffles are commonly made from concrete beams, steel plates, wood, or plastic, and, as shown in Figure 2, extend from the top of the sewer to just below the regulating weir. As flow rises in the CSS or storage facility, water passes under the baffle and over the regulator to the CSO outfall. Most floatables are trapped behind the baffle and remain in the CSS where they are transported to the treatment plant (EPA 1999a).

In-system netting is installed at strategic locations in the sewer system in concrete vaults, often near regulators in the outfall pipe. One or more nylon mesh bags are supported by a metal frame. Netting system design, including the aperture of the mesh nets, is based on the size and types of floatables targeted for capture and the anticipated volume of flow. Wet weather flows carry floatables into the nets, which are replaced periodically (EPA 1999a).

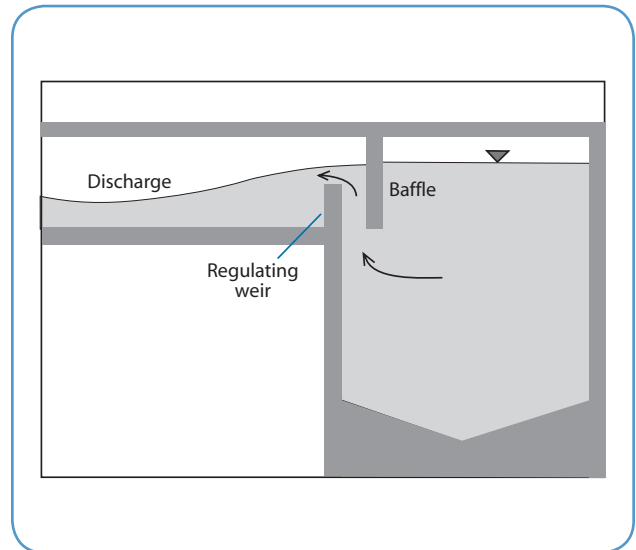

Figure 2. Baffle placement at a CSO regulator.

End-of-Pipe Controls

End-of-pipe controls use netting systems or containment booms and skimmer vessels to capture floatables in the receiving water after they have been discharged from the sewer system.

End-of-pipe netting systems consist of an in-water containment area that funnels CSO discharges through a series of nylon mesh bags attached to a modular pontoon structure. Also referred to as a floating netting system, nets are located a short distance from the CSO outfall, allowing the floatables to rise to the water surface after the discharge mixes with the receiving water (EPA 1999a). As with in-system nets, the size of the mesh net used will depend on the volume and type of floatables targeted for capture (EPA 1999a). After the nets become full, they are removed and disposed.

Containment booms can be located in a receiving water downstream of one or more CSO outfalls. The booms are floatation structures with a suspended curtain that captures buoyant materials. Booms are typically anchored to the shoreline and bottom of the waterbody. They may also be designed to absorb oils and grease. The size of the boom is determined by the volume of floatables expected from a design storm event. After a storm, floatables and other debris trapped by the boom will need to be removed with a vacuum truck, manually, or using a skimmer vessel (EPA 1999a).

Skimmer vessels are boats designed to gather floatables in lakes, harbors, or bays, and can be used in conjunction with containment booms. Skimmer vessels capture floatables using either a capture plate located at the bow of the boat that collects debris on a conveyor

belt system or by lowering large nets into the water. Skimmer vessels may require companion equipment to transport the debris for land disposal.

Key Considerations

Applicability

Source Controls

Street sweeping can be performed on any paved surface and is often already part of a municipality's standard activities. In colder climates, sweeping during the spring snow-melt reduces the road salt and sand load delivered to the CSS (EPA 2002). The optimal timing between street sweepings ranges from a few weeks to a month based on the amount of debris present on the street. The sediment removal efficiency of street sweeping as a function of the time between sweeps is illustrated in Figure 3.

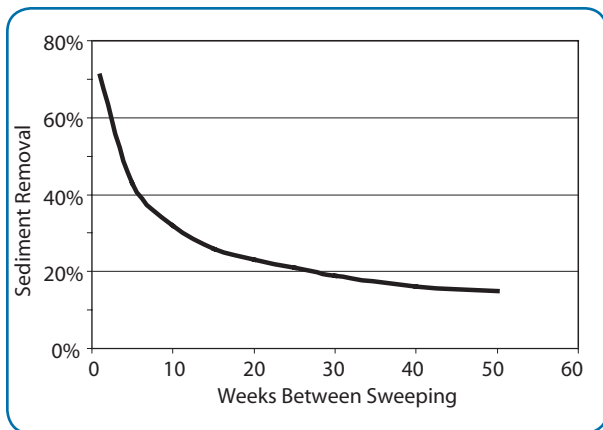

Figure 3. Cumulative sediment removal by street sweeping.

Catch basin modifications increase the capture of solids and floatables, which often necessitates more frequent maintenance. Without proper maintenance, catch basin performance can be compromised. The more solids and floatables that are collected and held in a catch basin, the less effective the basin becomes at trapping additional material. A catch basin filled with solids and floatables can have the unintended consequence of blocking the inlet to the sewer system. Catch basin cleaning frequencies vary greatly, with some municipalities performing maintenance annually and others scheduling catch basin cleaning once every five to six years. Often, individual basins are cleaned as specific needs arise, such as citizen complaints of localized street flooding. In general, a cleaning frequency of at least twice per year maintains the effectiveness of catch basins for pollutant removals (Moffa 1997). Manual and vacuum cleaning are two methods available to remove accumulated debris from catch basins (EPA 1999b).

Collection System Controls

Screens can be used effectively for CSO control because they capture a significant amount of the floatables contained in CSO discharges. Removal efficiencies are tied closely to the spacing between bars or mesh aperture and can range from 25-90 percent of the total solids. The effectiveness of screening is reduced significantly by the presence of oil and grease in the flow (EPA 1999a). Many screens are self-cleaning but regular maintenance is required to ensure their effectiveness. Finer screens have higher removal efficiencies, but are more susceptible to clogging and tearing and may require maintenance after every CSO event. Additional information on fine screens is presented in the "Supplemental Treatment Technology Description" included in Appendix B of the *Report to Congress on the Impacts and Control of Combined Sewer Overflows and Sanitary Sewer Overflows*.

The design of existing regulators or storage facilities will determine the effectiveness of baffles, as well as the cost to retrofit the structure. In some retrofits, the addition of baffles may restrict access to the regulators making maintenance more difficult. When a new structure is installed, baffles can be included in the design. Maintenance requirements for baffles are low compared to other floatables controls, requiring only occasional cleaning to remove debris and reduce odors.

In-line netting units are widely applicable and can be adapted to most CSSs (EPA 1999a). Access to in-system netting is important since the mesh bags must be inspected after each overflow event and changed when full. The frequency of bag changing depends on site-specific conditions, including the frequency and volume of CSO events and the volume of floatables in the discharges. Cities report changing the mesh bags between 12 to 36 times a year. Field tests indicate netting can provide removal efficiencies of up to 90 percent for floatables (EPA 1999a).

End-of-Pipe Controls

The nature of the receiving water influences the applicability of end-of-pipe controls. End-of-pipe netting systems are most suitable for lakes, estuaries, and tidal waters (EPA 1999a). Netting systems are sized based on the peak flow expected, the maximum flow velocity, and the quantity of floatables and other debris per million gallons of CSO. End-of-pipe netting systems require a minimum water depth of two feet and should not be located near heavily traveled waterways. As described in the discussion of in-line netting

systems, end-of-pipe systems have relatively high maintenance requirements.

Site conditions, such as receiving water velocity, should be considered when evaluating containment boom design, placement, and anchoring. Although booms float and can therefore accommodate some fluctuation in water level, high river velocities and winds may dislodge them. Furthermore, booms cannot be used during winter months in waters that are subject to freezing. Maintenance requirements for containment booms are moderate relative to other floatables controls; floatables trapped behind booms will need to be removed periodically.

Skimmer vessels are used to clean broad areas of open water. As a result, the floatables and other debris collected are likely to come from a variety of sources including CSOs, separate storm water systems, and upstream sources. Ice and high wind can impede

skimmer vessel navigation and the collection of floatables. It is also important to be aware of minimum depth and clearance height requirements specific to each vessel (EPA 1999a).

All end-of-pipe systems can create temporary unsightly conditions near CSO outfalls, and therefore, may be inappropriate in areas with waterfront development.

Cost

A summary of cost and maintenance considerations, as well as the relative capture efficiency, for each of the floatables control technologies is presented in Table 1. Representative costs from actual applications are presented in Table 2.

Table 1. Comparison of floatables control technologies.

Category	Technology	Capital Cost	Maintenance Requirements	Floatables Capture Efficiency
Source Controls	Street Sweeping	H ¹	M	L
	Catch Basin Modifications	L	M	M
Collection System Controls	Screens and Trash Racks	M	L	M
	Baffles	M	L	M
	In-System Netting	M	H	H
	End-of-Pipe Netting	M	H	H
End-of-Pipe Controls	Containment Booms	H	M	H
	Skimmer Vessels	H ¹	M	M

¹ Assumes program would require vehicle/vessel purchase.

Table 2. Cost comparison of floatable control technologies.

Category	Technology	Cost
Source Controls	Street Sweeping	<p>Costs depend on frequency of cleaning, volume of litter, enforcement of parking regulations, and other labor costs.¹</p> <p>Contracted street sweeping costs \$130-\$150 per curb mile.²</p> <p>Plymouth Township, MI, swept 511 miles of curb at a cost of \$68 per mile.²</p> <p>Vacuum sweeping trucks cost between \$150,000-\$200,000 depending on the material holding capacity. Maintenance costs range from \$12,500-\$15,000 per truck per year.¹</p>
Collection System Controls	Screens and Trash Racks	<p>Cost for screens depends on the size of the screen, the means of cleaning, construction materials, flow rate, and whether construction is new or a retrofit. Costs can range from \$40,000 to \$9 million per screen.⁴</p> <p>Seattle, WA, installed 25 MGD rotary screen for approximately \$1.7 million.⁴</p>
	Baffles	Steel or aluminum curtains are usually used for retrofits at an average cost of less than \$10,000 each. ³
	Catch Basin Modifications	<p>Costs range from \$65-\$100 per basin.¹</p> <p>Trash buckets can cost an average of \$100 per basin to install.³</p> <p>Contracted catch basin cleaning costs range from \$50-\$170 per hour.³</p>
	In-Line Netting	<p>Netting system costs range from \$75,000-\$300,000 per site.⁵</p> <p>Operations and maintenance (O&M) costs for changing full nets are \$1,000 per site.³</p>
End-of-Pipe Controls	End-of-Pipe Netting	Netting system costs range from \$25,000-\$300,000 per site. ⁵
	Containment Booms	<p>Installation costs for booms range from \$100,000-\$150,000 per site.³</p> <p>O&M costs for changing full nets are approximately \$1,000 per site.³</p>
	Skimmer Vessels	<p>Skimmer vessels cost between \$300,000-\$700,00 depending on vessel features.³</p> <p>O&M costs can range between \$75,000-\$125,000 per year per boat.³</p> <p>A pier conveyor to remove debris from the vessel can cost \$37,000.⁶</p>

¹ EPA 1999b² Ferguson 1997³ EPA 1999a⁴ EPA 1999c⁵ EPA 1999d⁶ Shenman 2003

Implementation Examples

PORTLAND, ME

Street Sweeping

Responsible Agency: City of Portland Public Works Department

Population Served: 190,000

Service Area: 17.7 sq. mi.

Sewer System: Not Available

The City of Portland Sweeping Program sweeping crews work five nights a week from late March to the beginning of December. During the sweeping season, the crews routinely sweep a total of 480 curb miles. The city tries to sweep each street at least once a month and twice a month if the street is more heavily trafficked. One section of town has daytime sweeping at the request of the area residents. A parking program is in effect in the downtown portion of the city and an odd/even parking program is used

in residential areas. The sweepers are effective in removing debris from the streets of Portland. It is estimated that during the spring street cleaning, up to 9,000 tons of sand and salt are caught before entering the sewer system.

The sweeping fleet consists of eight sweepers with an annual maintenance budget of \$125,000. The total annual budget of the program is \$412,000 or \$51,500 per sweeper.

More information at <http://www.ci.portland.me.us/publicworks/street.htm>

NEW YORK CITY, NY

City-Wide Floatables Study

Responsible Agency: New York City Department of Environmental Protection

Population Served: 7.6 million

Service Area: 297 sq. mi.

Sewer System: 4,200 mi. of combined sewer, 1,800 mi. of sanitary sewer

New York City studied street sweeping extensively in the early 1990s, as part of a city-wide effort to reduce CSO discharges of floatable material to New York Harbor (NYCDEP 1995). The study found that the primary sources of floatables were trees, littering, and spilled trash receptacles. Most debris was found within 3.5 feet of the curb. As shown in the table below, plastics were the most prevalent floatable material by volume.

Enhanced mechanical sweeping within a 450-acre study area (increased from two times per week to six times per week) produced a 42 percent reduction in floatables on an item count basis, and a 54 percent reduction on a weight basis. Using a city-wide model, it was estimated that street sweeping twice per week would reduce floatables loadings to New York Harbor by 29 percent from current levels, and that increasing the frequency to three times per week would bring the total reduction in floatables to 49 percent.

In addition to street sweeping, the city has implemented various other floatables control practices. The city also retrofitted numerous catch basins with hoods. NYCDEP has installed 23 containment booms near CSO outfalls. Once floatables are collected by the containment booms, they are removed using the city's fleet of skimmer vessels. The city operates four skimmers designed for smaller tributary streams and one designed for open water conditions. Some areas have also been equipped with end-of-pipe netting systems, including the Fresh Creek outfall, one of the city's largest. Studies have shown that the Fresh Creek net has a capture efficiency of 90-95 percent.

Program costs include \$6.5 million to purchase and engineer the containment booms/nets; \$6.8 million to purchase and operate the skimmer vessels; and \$6.7 million to purchase 41 catch basin cleaning trucks or \$164,000 per truck.

More information at <http://home.nyc.gov/html/dep/html/float.html>

Type of Material	Volume of Floatables (%)
Plastic	56
Glass	12
Metal	7
Styrene	7
Cloth	6
Paper	5
Wood	4
Misc	2
Rubber	1

NORTH BERGEN, NJ

Responsible Agency: North Bergen Municipal Utilities Authority

Population Served: 48,000

Service Area: 1.8 sq. mi.

Sewer System: Not Available

CSO Floatables Control Facilities

In 1999, North Bergen installed numerous solids and floatables control technologies, including a mechanical screen bar, four in-system netting systems, and five end-of-pipe netting systems. An Army surplus boom truck was purchased for net removal. A dump truck then transports the nets to the wastewater treatment plants, where the floatables are disposed of with the screenings taken from flows entering the plant. A portable vacuuming system is available to remove fine solids.

Replacement of the nets depends on the physical characteristics of the CSS upstream of the netting system. The in-line nets in relatively flat areas of the sewer system collect more silt and grit than those downstream of areas with steeper terrain. Changing the nets at a single location usually takes two hours, but can take up to four hours if the site must be vacuumed. The least active CSO facility is serviced four times a year, whereas the most active is serviced an average of once per month. A total of 90 tons of floatables were collected between 1999-2002.

The actual construction cost for the CSO facilities was \$3.3 million. Supporting equipment such as the boom truck and vacuum unit cost \$80,000; it is estimated that annual operation and maintenance costs are \$57,373.

Contact: Frank Bruno, Maintenance Supervisor, City of North Bergen

BALTIMORE, MD

Responsible Agency: Department of Public Works, Bureau of Water and Wastewater

Population Served: 1.8 million

Service Area: Not Available

Sewer System: 3,100 mi. of sewer

Keeping Inner Harbor Clean

Baltimore's Inner Harbor has become a symbol of success for waterfront revitalization efforts around the country. With more people visiting the harbor, it is important to remove the debris and trash discharged into the harbor from the city's CSS and separate storm water systems. In 1988, the

city purchased its first skimmer vessel and currently maintains a fleet of four boats. The original skimmers were made of machine steel, which have been refurbished using stainless steel because of the brackish nature of the harbor. The boats remove floatables, such as styrofoam cups and soda bottles, as well as large and unusual items, such as refrigerators. Once the floatables are collected, they are off loaded using a pier-conveyor into dumpsters for later disposal. Patrolling 25 miles of coastline, the skimmers collect approximately 394 tons of floatables per year. The city has seen marked improvement in the appearance of the water in Inner Harbor with the use of the skimmer vessels. Over the years, Baltimore has purchased skimmer vessels of varying capacity; costs for individual boats have ranged from \$200,000 to over \$500,000.



United Marine International, LLC

Contact: Tom Finnerty, Manager, Marine Operations in Baltimore Department of Public Works

References

EPA Office of Water. 1999a. *Combined Sewer Overflow Technology Fact Sheet: Floatables Control*. EPA 832-F-99-008.

EPA Office of Water. 1999b. *Combined Sewer Overflow Management Fact Sheet: Pollution Prevention*. EPA 832-F-99-038.

EPA Office of Water. 1999c. *Combined Sewer Overflow Technology Fact Sheet: Screens*. EPA 832-F-99-040.

EPA Office of Water. 1999d. *Combined Sewer Overflow Technology Fact Sheet: Netting System for Floatable Control*. EPA 832-F-99-037.

EPA. 2002. "Pollution Prevention/Good Housekeeping for Municipal Operations: Parking Lot and Street Cleaning." Retrieved December 9, 2002. http://cfpub.epa.gov/npdes/stormwater/menuofbmeps/poll_10.cfm

Ferguson, T. et al. 1997. "Rouge River National Wet Weather Demonstration Project: Cost Estimating Guidelines Best Management Practices and Engineering Controls." December 9, 2002. <http://www.rougeriver.com/pdfs/stormwater/sr10.pdf>

Moffa, P.E. (Ed.). 1997. *Control and Treatment of Combined Sewer Overflows*. 2nd ed. New York, NY: Van Nostrand Reinhold.

New York City Department of Environmental Protection (NYCDEP). 1995. *City-Wide Floatables Study*. Prepared by HydrQual, Inc. Mahwah, NJ: NYCDEP.

Shenman, Lou, President - United Marine International (UMI). Interview by Limno-Tech, Inc., 2003. Washington, DC.

Water Environment Federation (WEF). 1999. *Prevention and Control of Sewer System Overflows: Manual of Practice No. FD-17*. Edited by Gray, W. et al. Alexandria, VA: WEF.

Inclusion of this technology description in this Report to Congress does not imply endorsement of this technology by EPA and does not suggest that this technology is appropriate in all situations. Use of this technology does not guarantee regulatory compliance. The technology description is solely informational in intent.



TECHNOLOGY DESCRIPTION

LOW IMPACT DEVELOPMENT

Porous Pavement

Overview

Porous pavement is an infiltration system where storm water runoff is infiltrated into the ground through a permeable layer of pavement or other stabilized permeable surface (EPA 1999a). Porous pavement is considered a low impact development (LID) control intended to replicate pre-existing hydrologic site conditions through application of innovative land planning and engineering design. The use of porous pavement reduces or eliminates impervious surfaces, thus reducing the volume of storm water runoff and peak discharge volume generated on a site. This curtailment in storm water generation can keep storm water from entering combined sewer systems and taking up valuable conveyance and storage capacity. This in turn can lead to reductions in the volume or frequency of CSOs or stormwater discharges.

There are several types of porous pavement. Porous asphalt consists of an open-graded coarse aggregate that is bonded together by asphalt cement with enough interconnected voids and sufficient permeability to allow water to infiltrate through the medium and into the underlying soil quickly (EPA 1999b).

Porous concrete consists of uniform, open-graded, coarse aggregate and a lower water-to-cement ratio, which produces a pebbled, open surface that is roller compacted. Similar to porous asphalt, porous cement has interconnected voids that increase its permeability. Porous pavers are pre-fabricated units, rather than a medium, that come in two general types: block pavers and grass pavers. Block pavers consist of interlocking paving materials where the void areas are filled with pervious materials such as sand or grass (GSMM 2001). Grass pavers are mats of high strength plastic grids (often made of recycled materials) that are filled with gravel. An engineered aggregate material or a sand and soil mixture is installed beneath the grid and gravel that allows grass to grow through the gravel to the surface (TBS 2002). The grids function as mini-holding

ponds where storm water is collected and infiltrated into the ground.

Installation techniques for porous pavement vary depending on the type of porous pavement utilized. As shown in Figure 1, a typical porous pavement system consists of the following layers: (1) porous pavement; (2) gravel or coarse sand; (3) filter fabric; (4) reservoir consisting of 1.5-3 inch diameter stones; (5) gravel or sand layer; (6) optional filter fabric; and (7) undisturbed existing soil (EPA 1999b). The water storage capacity of the stone reservoir beneath the pavement can vary. Perforated overflow pipes may be installed near the top of the reservoir to drain excess storm water when the reservoir is full.

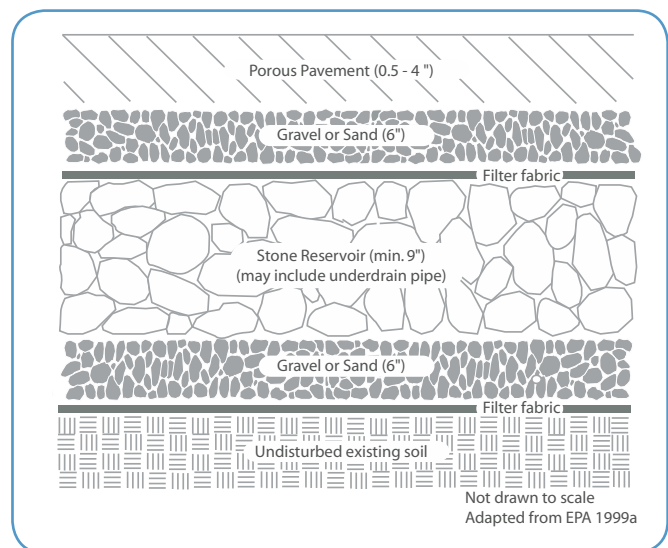

Figure 1. Porous pavement cross-section.

Key Considerations

Applicability

Porous pavement can be used in place of conventional impervious pavement under certain conditions. Typically,

porous pavement is most suitable for areas with sufficient soil permeability and low traffic volume. Porous pavement is a useful option in urban areas where little pervious surface exists, provided that the grade, subsoil, drainage characteristics, and groundwater conditions are suitable (EPA 1999b). Common applications include: parking lots, shoulders of airport runways, residential driveways, street parking lanes, recreational trails, golf cart and pedestrian paths, and emergency vehicle and fire access lanes. Use of this technology may be more limited in arid regions with high wind erosion and cold regions where sand can clog pores and road salt can contaminate groundwater. Also, they should not be installed in areas that generate highly contaminated runoff such as commercial nurseries, auto salvage yards, fueling stations, marinas, outdoor loading and unloading facilities, and vehicle washing facilities as the contaminants could infiltrate into the groundwater (SMRC 2002). The success of porous pavement applications depends on several key design criteria including site conditions, construction materials, and installation methods. These criteria are further described in Table 1.

Advantages

The primary advantage of porous pavement is a reduction in the volume of storm water runoff generated on site. By reducing runoff, porous pavement can reduce the need for storm water holding systems; allow the use of smaller, less expensive storm water collection systems; reduce the need for curbs, gutters, and inlets; maximize waste water

conveyance capacity in combined sewer systems; and reduce puddling and flooding. A secondary advantage of porous pavement is that it can remove both soluble and particulate pollutants such as total phosphorus, total nitrogen, and heavy metals via natural filtration through the underlying soil (GSMM 2001). By promoting pollutant treatment, porous pavements reduce the potential impact of storm water runoff on local receiving waters.

Disadvantages

A major disadvantage of porous pavement is its tendency to clog. This can occur as a result of improper design or construction, but it occurs most commonly from a lack of maintenance (WMI 1997). Proper maintenance includes periodic vacuum sweeping followed by high-pressure hosing to remove sediment from the pores (EPA 1999b). Once clogged, it is very difficult and expensive to rehabilitate porous pavement, often requiring complete replacement (EPA 1999a). Another disadvantage is the lack of expertise of pavement engineers and contractors with this technology. In addition, some building codes may not allow installation. Since not all soils are absorptive enough to provide proper drainage, selection of the technology must be based on site-specific considerations (TBS 2002). If the underlying soils are unable to dry out between storm events, anaerobic conditions may develop which can result in odors.

Table 1. Design criteria for porous pavement (EPA 1999b).

Design	Criterion Guidelines
Site Evaluation	<ul style="list-style-type: none"> • Take soil samples by boring to a depth of at least 4 feet below bottom of stone reservoir to check permeability, porosity, depth of seasonally high water table, and depth to bedrock • Not recommended on slopes greater than 5% and best with slopes closer to 0%. • Minimum depth to bedrock and seasonally high water table: 4 feet • Minimum infiltration rate of 3 feet below bottom of stone reservoir: 0.5 inches per hour • Minimum setback from water supply wells: 100 feet • Minimum setback from building foundations: 10 feet downgradient, 100 feet upgradient • Not recommended in areas where wind erosion supplies significant amounts of windblown sediment • Drainage area should be less than 15 acres
Traffic Conditions	<ul style="list-style-type: none"> • Use for low-volume automobile parking area and lightly used access roads • Avoid moderate to high traffic areas and significant truck traffic
Design Storage Volume	<ul style="list-style-type: none"> • Highly variable; depends upon regulatory requirements. Typically designed for storm water runoff volume produced in the drainage area by the 6-month, 24-hour storm event
Drainage Time for Design Storm	<ul style="list-style-type: none"> • Minimum: 12 hours • Maximum: 72 hours • Recommended: 24 hours
Construction	<ul style="list-style-type: none"> • Excavate and grade with light equipment with tracks or oversized tires to prevent soil compaction
Pretreatment	<ul style="list-style-type: none"> • Pretreatment, such as bioretention or vegetative swales, recommended for runoff with high levels of suspended solids

Cost

Porous pavement can initially cost more than traditional pavement. The overall cost-effectiveness varies depending on the site conditions, design requirements, and local installation and long-term maintenance costs. For porous asphalt and cement, the raw materials are the same as those utilized in conventional paving operations, but contractors may charge higher prices for jobs that involve unfamiliar formulas or techniques. For porous pavers, the cost can vary depending on the type utilized. Both grass pavers and block pavers require a high level of construction workmanship and expertise to ensure proper installation (GSMM 2001). The range of costs estimated for basic installation of porous pavement is summarized in Table 2.

Estimated cost for an average annual maintenance program for a porous pavement parking lot is approximately \$200 per acre per year (EPA 1999b). This cost estimate assumes four inspections each year with appropriate vacuum sweeping and jet hosing. Savings from reduced investments in storm sewer extensions and costs associated with storm drain systems (i.e. repair and maintenance) have the potential to offset the initial costs.

Table 2. **Estimated costs for installation.**

Paver System	Cost (Sq. Ft)	Life Span ¹
Traditional & Porous Asphalt	\$0.50 to \$1.00	20 yrs
Traditional & Porous Concrete	\$2.00 to \$6.50	20 yrs
Grass Pavers	\$1.50 to \$5.75	~20 yrs
Block Pavers	\$5.00 to \$10.00	~20 yrs

¹Actual values may vary as life span is site specific and maintenance dependent

Implementation Examples

RENTON, WA

Responsible Agency: University of Washington Center for Urban Water Resources

Porous Pavers Pilot Test

The University of Washington Center for Urban Water Resources undertook a pilot test of porous pavement in the King County Department of Public Works building parking lot in Renton, WA. Four types of porous pavement were installed in sections of the lot: (1) grass pavers with virtually no impervious surface, (2) plastic grid pavers with grass and gravel in-filling with 60 percent impervious surface, (3) concrete pavers with grass in-filling with 60 percent impervious surface, and (4) concrete block pavers with 90 percent impervious surface. There were sections of the parking lot that were unmodified and thus left as impervious surfaces (asphalt). Runoff volumes from the porous and impervious sections were monitored during several storm events in 1996 and in a follow-up evaluation in 2002. Monitoring during the 1996 study and the 2002 follow-up study showed that the impervious asphalt surface generated a significant amount of runoff for the majority of precipitation events. Whereas, minimal storm runoff was generated on the porous pavers as virtually all precipitation from the observed storms was infiltrated. Therefore, replacing asphalt with pervious pavement would decrease surface runoff and attenuate peak discharges. The study found no significant differences in the performance of different types of pavers. The follow-up study in 2002 demonstrated that the porous pavement systems were structurally functional after six years of daily use. The concrete pavers and block pavers were found to be particularly robust, while the grass and gravel pavers did undergo some minor wear.



Photo: University of Washington

Contact: Derek B. Booth, Center for Urban Water Resources Management, University of Washington

TAMPA, FL

Responsible Agency: Florida Aquarium

Florida Aquarium Storm Water Study

The 11.25 acre parking lot at the Florida Aquarium in Tampa, FL, was modified for a study that compared storm water runoff reduction rates from several different porous pavement applications including swales, asphalt pavement with swales, asphalt pavement without swales, and cement pavement with swales. Swales, which are areas of vegetation, were placed between the rows of parking stalls without reducing the total number of stalls. Results showed that for all rainfall events that produced flow, the basin with pervious paving and a swale reduced runoff by over 60 percent compared to asphalt pavement with no swale. Also, the area with porous pavement reduced the average amount of runoff by 41 percent compared to the other areas with swales and impervious pavement. Porous pavement was found to be more effective for small storms; for rainfall events less than 0.8 inch, the area with porous pavement and a swale had 80-90 percent less runoff than the asphalt pavement without a swale.

Contact: Betty Rushton, Southwest Florida Water Management District

KINSTON, NC

Responsible Agency: NC State University

Parking Lot Demonstration Project

A porous pavement parking lot was designed as a demonstration project, monitoring the amount of storm water runoff controlled by both block pavers and grass pavers. The parking lot was 9,340 square ft and was considered an ideal candidate because it was not a high traffic area, the *in situ* soil had sufficient capacity, and there was no indication of a seasonally high water table within five feet of the surface. Modular and grass pavers were installed in separate areas of the lot, and runoff volumes were monitored from June 1999 through July 2001. Monitoring results indicated that runoff from the concrete paver parking lot occurred only 11 out of the 48 wet weather events recorded (less than 25 percent of total storms during study period). In addition, rational method runoff coefficients for the permeable pavement used in this study were calculated. Rational method runoff coefficients (0-1.0) are a way of describing the amount of runoff generated during a wet weather event; a coefficient of 0 reflects maximum rainfall infiltration, whereas a coefficient of 1.0 reflects maximum runoff generation. The estimated runoff coefficient for the permeable pavement in this study ranged from 0.1-0.48, depending on method used and amount of precipitation recorded. The project cost was estimated to be 25 percent more than the cost of building a conventional asphalt parking lot.



Photo: North Carolina State University

Contact: Bill Hunt, North Carolina State University

References

Booth, D. B. and J. Leavitt, 1999. "Field Evaluation of Permeable Pavement Systems for Improved Storm Water Management". Journal of the American Planning Association. 65:314-325.

Booth, D.B. and Ben Brattebo, 2002. "Permeable Parking Lot Demonstration Project–The Six-Year Follow-Up". Draft submitted to Water Research.

EPA Office of Water. 2000. Low Impact Development (LID) A Literature Review. EPA-841-B-00-005.

EPA Office of Water. 1999a. Preliminary Date Summary of Urban Storm Water Best Management Practices. EPA-821-R-99-012.

EPA Office of Water. 1999b. Storm Water Technology Fact Sheet Porous Pavement. EPA 832-F-99-023.

Georgia Storm Water Management Manual (GSMM)(Volume 2). 2001.
<http://www.georgiastormwater.com>

Low Impact Development Center. "Permeable Paver Costs." Retrieved October 25, 2002. http://www.lid-stormwater.net/permeable_pavers/permpaver_costs.htm

Storm Water Manager's Resource Center (SMRC). "Storm Water Management Fact Sheet: Porous Pavement." October 25, 2002.
<http://www.stormwatercenter.net>

Tool Base Services (TBS). "Permeable Pavements" Retrieved October 25, 2002.
<http://www.toolbase.org/tertiaryT.asp?TrackID=&CategoryID=38&DocumentID=2160>

Watershed Management Institute (WMI), 1997. Operation, Maintenance, and Management of Storm Water Management Systems. Ingleside, MD.

Inclusion of this technology description in this Report to Congress does not imply endorsement of this technology by EPA and does not suggest that this technology is appropriate in all situations. Use of this technology does not guarantee regulatory compliance. The technology description is solely informational in intent.



TECHNOLOGY DESCRIPTION

LOW IMPACT DEVELOPMENT

Green Roofs

Overview

A green roof is a type of low impact development (LID) control that uses soil and plant growth for the purpose of rooftop runoff management. The rooftop vegetation and underlying soil serve to intercept storm water, delay runoff peaks, and reduce runoff discharge rates and volume. This can lead to reductions in the volume or occurrence of CSOs. A green roof is intended to minimize the impact of development on hydrologic site conditions through application of innovative building and engineering design. Green roof technology has been used in Europe for over 25 years and is gaining increased recognition in the United States. As shown in Figure 1, the series of engineered layers that make up a green roof, from bottom to top, typically include (GBS 2002):

- Waterproof membrane to protect the roof deck
- Root barrier to prevent roots from penetrating the waterproof membrane
- Optional insulation
- Drainage layer to direct excess water from the roof
- Filter fabric to keep fine soil from clogging the layers below
- Engineered soil substrate or growing medium
- Vegetation

There are two basic types of green roofs: intensive and extensive (Peck and Kuhn 2002). Factors to consider when choosing which type of green roof to install include: location, structural capacity of the building, budget, material availability, and client and/or tenant needs.

Intensive Green Roofs

Intensive green roofs, more commonly known as conventional roof gardens, can be landscaped environments developed for aesthetics and recreational uses. The landscaped roofs are likely to include garden-variety and food producing plants requiring high levels of management, though the degree of maintenance

can be reduced by using tolerant plants that would deal well with the micro-climate of the particular roof (Beckman *et al* 1997). As ten inches or more of soil depth is necessary for growing larger trees and shrubs, intensive green roofs can add as much as 80-150 pounds per square foot of load to the underlying structure (Sholz-Barth 2002) and often require an irrigation and drainage system. Food-producing plants are usually planted in containers rather than directly onto the rooftop. Intensive roofs are usually installed on flat roofs.

Extensive Green Roofs

In contrast to intensive green roofs, extensive green roofs (also called eco-roofs) are primarily utilized for their environmental benefits (Beckman 1997). This type of roof is composed of a continuous thin growing medium which sustains low-maintenance vegetation tolerant of local climatological conditions. Extensive roofs require little maintenance after the vegetation is established, typically within the first year or two after installation, and irrigation systems are generally

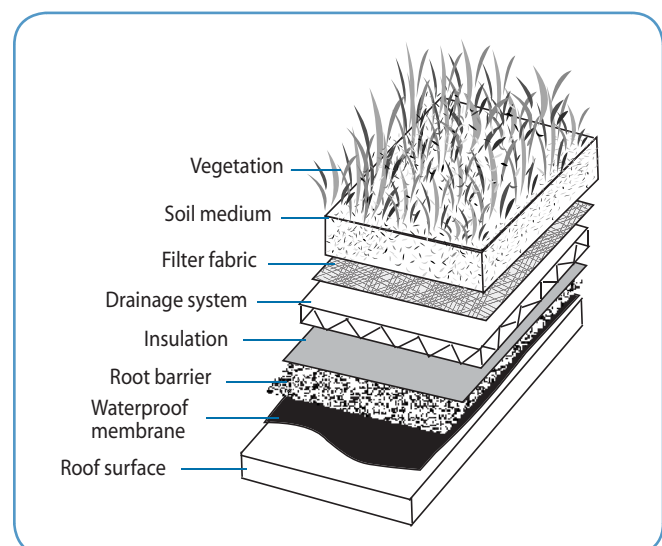

Figure 1. Typical layers of a green roof.

unnecessary. Suitable for large roofs, vegetated cover will extend across the entire roof and should only be accessed to perform periodic maintenance. The extensive green roof can be more readily retrofitted to an existing structure due to smaller loads, typically ranging between 15-50 pounds per square foot (Sholz-Barth 2001). In addition, extensive roofs can be installed on roofs with slopes up to about 25 percent (MUSS Manual 2001).

Design considerations for waterproofing, drainage, and soil type are important in any type of green roof. Common waterproofing options are rubber, modified bituminous membrane, polyvinyl chloride (PVC), rubberized asphalt, thermal polyolefins (TPO), and coal tar pitch (GBS 2002; Miller 2002). The two most common waterproofing materials are PVC and modified bituminous membranes (Miller 2002). To discourage roots from penetrating the waterproofing in intensive roof systems, a physical or chemical root barrier is usually installed over the protective layer. The key to moisture management and drainage is the use of absorptive growth media (Miller 2002). There are various drainage materials that can be used for moisture management including a synthetic sheet such as polystyrene or a granular drainage media. Depth of the drainage layer varies, depending on the level of runoff management desired and roof loading capacity. A geosynthetic filter mat is usually placed between the soil and drainage material to prevent the drainage system from becoming clogged with fine particles from the soil. Soils used for vegetated roofs are lighter in weight than typical soil mixes; they are usually 75 percent mineral aggregate and 25 percent organic material (MUSS Manual 2001).

Key Considerations

Applicability

Green roofs can be incorporated into new building design or retrofitted to existing buildings. Green roofs can be fitted to commercial buildings, multi-family homes, industrial structures, as well as single-family homes and garages. Depending on whether the system is intensive or extensive, green roofs can be installed on either flat or sloping roofs. Newly developed synthetic drainage materials have made green roofs feasible to install on most conventional flat roofs. The appropriate choice of vegetation is determined by substrate type, soil thickness, regional climate, and expected precipitation. Intensive and extensive green roofs have been successfully installed in cities with varying climatic conditions across the United States. Some factors that must be considered are the load-bearing capacity of the

roof deck, the moisture and root penetration resistance of the roof membrane, roof slope and shape, hydraulics, and wind shear. In regions of the country where snow is part of the expected annual precipitation, the maximum roof design loads must incorporate expected snow accumulation and drifting patterns.

Green roofs can be an important tool to reduce storm water runoff and subsequent CSOs in areas with dense development. Heavy development in urbanized areas may preclude the use of other space-intensive storm water management practices such as storm water management detention ponds and large infiltration systems. In these situations, green roofs may be a cost-effective technique for reducing storm water volumes. They can also be a component of an integrated runoff management program using a combination of low impact development practices.

Advantages

In a green roof system, storm water is released slowly over a period of several days rather than discharging immediately into a sewer system (Beckman *et al* 1997). Studies show that both extensive and intensive green roofs can absorb as much as 75 percent of the precipitation during a typical rainfall event (Sholz-Barth 2001), while runoff from low volume storms may be eliminated entirely. The choice of soil substrates and vegetation will determine the storm water retention capacity of the roof. When fully saturated, storm water runoff is filtered through the vegetative layer to a drainage outlet. The following formula estimates the potential gallons of precipitation captured based on acres of green roof area and average annual rainfall (City of Portland 2002):

$$\begin{aligned} &[(\text{Acres of Green Roof}) \times (43,560 \text{ foot}^2/\text{acre}) \times (144 \text{ inch}^2/\text{foot})^2 / \\ &(231 \text{ inch}^3/\text{gallon})] \times (60 \% \text{ of Annual Rainfall in Inches}) \\ &= \text{Gallons Rainfall Captured} \end{aligned}$$

The gallons of runoff potentially captured by green roofs in various cities can be calculated based on annual rainfall statistics and assuming 100 acres of vegetated roof cover. Table 1 shows hypothetical results for green roofs in Atlanta, GA; Chicago, IL; Philadelphia, PA; and Portland, OR. These results will vary depending on rainfall patterns and whether the rainfall was preceded by a dry period, which affects absorption.

An additional benefit to green roofs is they can filter airborne pollutants that are deposited via precipitation on the roof (i.e., nitrogen and particulate matter). They can also help counteract the “urban heat island effect,” created when the natural environment is replaced by pavement

and buildings; green roofs provide a cooling effect as the plants' foliage evaporate moisture via the process of evapotranspiration. In addition, green roofs can help

Table 1. Hypothetical gallons of storm water captured, assuming 100-acres of green roof cover.

City	Avg. Annual Rainfall (Inches)	Potential Gallons Captured (Millions)
Atlanta, GA	48	78
Chicago, IL	35	57
Philadelphia, PA	45	73
Portland, OR	37	60

reduce the roof temperature and insulate the building, as well as have aesthetic benefits. Vegetated covers can prolong the life of a roof by providing ultraviolet protection and reducing impacts resulting from extreme temperature fluctuations and high winds. The typical life-span of a green roof is about 40 years, significantly longer than a conventional roof. When used as accessible park-like building amenities, roof gardens can provide substantial aesthetic benefits. Where self-sufficient native vegetation tolerant of natural elements is used in green roofs, minimal maintenance is required.

Disadvantages

Potential disadvantages of green roofs include the difficulty of repairing possible leaks that are buried under the plant and soil substrate layers; additional structural support load requirements for substrate and vegetation layers; and cost considerations due to increased initial capital outlay. Roof slope can be a limiting factor as horizontal roofs will require a system that drains excess water from the root zones, while

sloped roofs may need erosion control measures. Also, maintenance costs may exceed those of a conventional roof. Buildings that are retrofitted with green roof covers are likely to incur more costs than a building that incorporates green roofs in its construction. For example, a building may need upgraded structural support for the added weight of the green roof.

Cost

The average cost of a green roof is estimated at \$10-\$25 per square foot compared to conventional roofs that cost \$3-\$20 per square foot (LIDC 2002; City of Portland 2002). Factors influencing cost include: the size of the installation; design complexity; local expertise and suppliers; type and depth of growing medium; selected vegetation and planting methods (seed, plug, or pot); and irrigation requirements.

Costs associated with intensive vegetated roofs tend to be higher compared to extensive roofs due to increased development and maintenance needs including more water, fertilizer, weeding, and clipping (Beckman *et al* 1997). Although green roofs may initially cost more than conventional roofs, the increase in membrane life-span and the decreased frequency of replacement make the green roof a cost-effective choice (City of Portland 2002). Costs of green roof installation may decrease with further development of the green roof market in the United States. In Europe, costs are typically one-fourth of those in the United States due to a more established green roof market.

Implementation Examples

PHILADELPHIA, PA

Responsible Agency: Fencing Academy of Philadelphia

Like many urban areas on the east coast, 90 percent of all rainfall in Philadelphia occurs during storms with 24-hour volumes of two inches or less. The 3,000 square foot extensive green roof was installed on the existing roof with the goal of replicating natural processes in detaining and treating a rainfall volume. The green roof was designed to reduce the peak runoff rate of a standard two year, 24-hour design storm. The overall depth of the green roof is three inches, featuring a synthetic under-drain layer; thin and lightweight growth media; and, vegetation selected for their hardiness and tolerance of the local climate. Perennial *Sedum* varieties create a meadow-like setting and require no irrigation or regular maintenance. The green roof weighs less than five pounds per square foot when dry, and approximately 17 pounds per square foot when saturated. The light weight allows installation on the existing conventional roof without the need for structural adjustments. The saturated infiltration capacity is 3.5 inches per hour. A pilot-scale test monitoring rainfall and runoff found that the green roof was able to detain 65% of the rainfall over a nine-month period. Runoff was negligible for storm events with less than 0.6 inch of rainfall. Based on typical costs of green roofs, the cost of the green roof at the Fencing Academy is estimated at \$18,000 or \$6/sq. ft.



Photo: Roofscapes, Inc.

Green Roof Demonstration Project



Photo: Roofscapes, Inc.

Contact: Charlie Miller, Roofscapes, Inc.

PORTLAND, OR

Responsible Agency: City of Portland Housing Authority and Portland Bureau of Environmental Services

The Housing Authority of Portland, in cooperation with the City of Portland's Bureau of Environmental Services (BES), installed an 8,500 square foot extensive green roof atop the 10-story Hamilton Apartment building. The type of vegetation used is hardy plants species such as *Sedum*, native wild flowers, and grasses. The Hamilton Apartment green roof system covers 60 percent of the total roof surface area and is comprised of two plots: the first is two inches thick and another is four inches thick. Storm events and runoff volumes are being monitored. During August 2001, a storm event was monitored for 9.5 hours by the BES. From a total measured rainfall of 1,485 gallons, 890 gallons ran off the two-inch plot and only 80 gallons ran off the four-inch plot. These runoff measurements do not take into consideration runoff generated from the remaining impervious areas of the roof (areas without green roof cover) that may be flowing into the green roof plots or directly into the drainage system. The estimated cost for the project was \$70,200.

The City of Portland acknowledges green roofs can play an important role in storm water management and have included them in their "Clean River Incentive and Discount Program," which is still under development. This program will offer incentives and discounts to commercial, industrial, institutional, and residential properties implementing storm water mitigation measures such as green roofs.



Photo: City of Portland Housing Authority

Contact: Tom Liptan, City of Portland Storm Water Specialist

CHICAGO, IL

City Hall Green Roof

Responsible Agency: City of Chicago

Twelve stories above ground, the demonstration green roof on Chicago's City Hall covers 20,300 of the 38,800 square foot roof surface area (one square city block). This roof was retrofitted as part of an urban heat island effect study initiated by EPA (City of Chicago 2002). The thickness of this green roof ranges from a 2.4 to 3.4-inches deep. Based on the structural capacity of the roof, it was determined that the roof could support an extensive system overall with intensive localized systems over the support columns. Given constraints such as snow load, the structural capacity for the roof was determined at an average of 30 pounds per square foot. The precipitation storage capacity was an average of one inch of rain. About 20,000 plants were used for the green roof, including those native to the Chicago region and tolerant of dry soil and sunny conditions. A drip-irrigation system, partially served by roof runoff collected in storage tanks, was installed as a supplemental water source for the plants during roof establishment and dry periods. Monitoring plant survival and environmental benefits related to energy and "urban heat island effect" is in process. Due to the expense of installing flow meters, storm water runoff is not being monitored at this site. The vegetated cover cost was \$500,000 of the entire re-roofing project cost, which totaled \$1.5 million.



Photo: City of Chicago

Contact: Mark Farina, City of Chicago

References

Beckman, S.; Jones, S.; Liburdy, K.; and Peters, C., *Greening Our Cities: An Analysis of the Benefits and Barriers Associated with Green Roofs*. Planning Workshop at Portland State University, 1997.
<http://www.greenroofs.com/Ecotrust%20Article.pdf>
<http://www.lsdg.net/EcoRoofs.pdf>

City of Chicago. "The components and design report of City Hall's Rooftop Garden." Retrieved December 2002.
<http://www.ci.chi.il.us/Environment/rooftopgarden/designpage.html>

City of Portland. "Ecoroof: Question and Answers" Retrieved December 2002.
http://www.cleanrivers-pdx.org/pdf/eco_questions.pdf

Green Building Services (GBS). "Green Rooftop Technology." Retrieved November 2002.
http://www.greenbuildingservices.com/green_resources/pdfs/ecoroofs.pdf

Low Impact Development Center (LIDC). "General Information on Green Roofs." Retrieved November 2002.
<http://www.lid-stormwater.net/intro/sitemap.htm#greenroofs>

Miller, Charlie. Interviewed by Limno-Tech, Inc. 2002.

Minnesota Urban Small Sites (MUSS). 2001. *BMP Manual: Storm Water Best Management Practices for Cold Climates*. Prepared for the Metropolitan Council Environmental Services by Barr Engineering Company.

Peck, Steven and Monica Kuhn. "Design Guidelines for Green Roofs." Retrieved October 18, 2002.
<http://www.cmhc-schl.gc.ca/en/imquaf/himu/loader.cfm?url=/commonspot/security/getfile.cfm&PageID=32570>

Sholz-Barth, Katrin. 2001. "Green Roofs: Stormwater Management from the Top Down." *Environmental Design & Construction Magazine*. Jan-Feb. 2001:1-11.

Inclusion of this technology description in this Report to Congress does not imply endorsement of this technology by EPA and does not suggest that this technology is appropriate in all situations. Use of this technology does not guarantee regulatory compliance. The technology description is solely informational in intent.



TECHNOLOGY DESCRIPTION

LOW IMPACT DEVELOPMENT

Bioretention

Overview

Bioretention is a soil and plant-based storm water management practice used to filter and infiltrate runoff from impervious areas such as streets, parking lots, and rooftops. Essentially, bioretention systems are engineered plant-based filters designed to mimic the infiltrative properties of naturally vegetated areas, which in turn can reduce the volume and frequency of CSOs. Bioretention is considered a low impact development (LID) practice and was developed in the early 1990s.

One of the unique qualities of bioretention is the flexibility of design themes. Bioretention systems can range in complexity depending on available funding, volume of runoff to be controlled, available land area, and the desired level of treatment. Bioretention systems can be used as a stand-alone practice (off-line) or connected to a storm drainage system (on-line). It is important to note that changes and improvements to a bioretention system design are continually being made as use of the practice becomes more developed.

On-line Bioretention System

A typical on-line bioretention system, as shown in Figure 1, includes components designed to capture, temporarily store, infiltrate, and treat storm water runoff. A graded surface conveys the runoff from impervious areas (i.e. roofs, driveways, parking lots) toward an optional grass buffer or swale. The grass buffer pretreats the runoff by reducing the runoff velocity, filtering particulates, and evenly distributing the incoming runoff. The rain garden, the main treatment component of an on-line bioretention system, is located in a depressed area that allows the runoff to pond and infiltrate, as well as evaporate from the surface. The rain garden is usually designed to hold up to six inches of standing water for one or two days, and consists of a mix of woody and herbaceous species planted in a soil mixture designed to optimize

percolation and pollutant removal. The best type of vegetation is native plant species that are tolerant of both wet and dry conditions. The planting soil should be two to four feet deep topped with an organic layer. This configuration allows the rain garden to maximize biological activity and enhance root growth. Factors affecting depth of the system include size of plants and depth to groundwater. Under the planting soil layer is a gravel layer that blankets an underdrain and serves to increase porosity of the system (Figure 1). The underdrain, a perforated pipe that collects and carries the runoff to the storm water system, ensures proper drainage for the plants and proper infiltration rates. Earlier bioretention system designs included a filter fabric between the soil and gravel layers, however this was found to cause premature clogging that led to infiltration problems. Replacing the filter fabric with a pea gravel diaphragm is an option. For storm flows exceeding the system's storage capacity, the excess

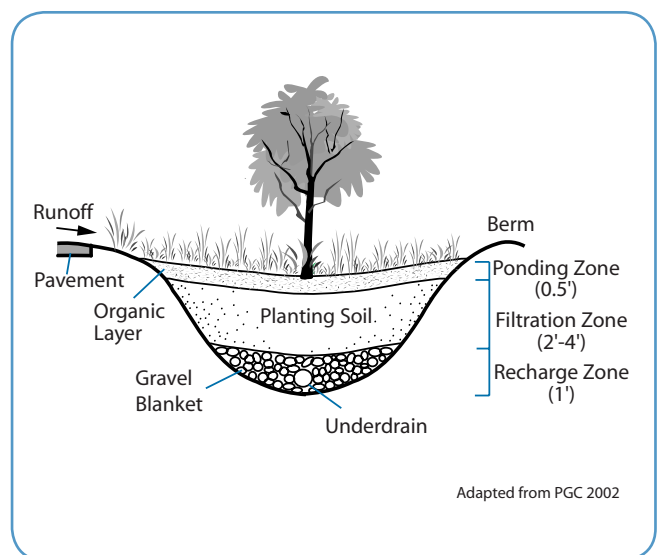

Figure 1. Cross-section of an on-line bioretention system.

runoff is allowed to flow over a grassy berm swale into an inlet pipe connected to the storm drain system. Other system designs allow the treated storm water to percolate back into the groundwater.

Off-line Bioretention Systems

Off-line bioretention systems possess similar general features to on-line systems, but are more simplistic and tend to be smaller in scale. One common design is where the bioretention areas (i.e. flower beds or other landscaping) are depressed so ponding and infiltration of storm water runoff can occur. Such designs do not include underdrains. Excess runoff overflows onto the adjacent surface areas. Another design is a bioretention “trap area” used in tree box areas, behind curbing, sidewalks, and pathways. With this technique, the paved surface is graded toward the adjoining grass areas to intercept runoff as it flows towards a drain or gutter (PGC 2002). Bioretention trap areas are common in urban areas with limited open space and high flow rates. In turn, tree boxes can be designed to serve as localized bioretention systems. This is done by creating a shallow ponding storage area by “dishing” mulch around the base of the tree or shrub (Figure 2).

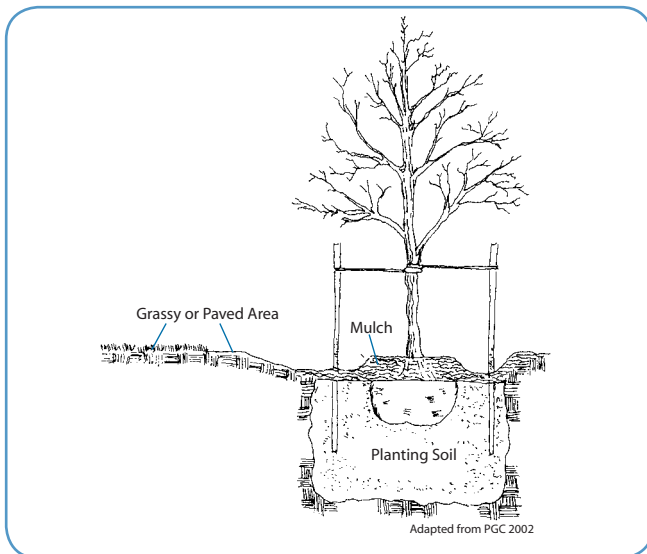

Figure 2. Schematic diagram of a tree-pit, which is a type of off-line bioretention system

Successful bioretention systems may also include soil amendments, which aim to improve health of the soil and its environmental functions. As a result of urban development, soils become compacted, which reduces soil porosity and ability to absorb water (ODEQ 2001). One type of soil amendment that can improve runoff absorption and treatment is the addition of compost. According to the Natural Resources Conservation Services (NRCS) hydrologic soils classification,

compacted urban soils are classified under Group D due to their limited ability to infiltrate runoff. Compost amendments can upgrade the compacted urban soils to Group B, soil with moderate infiltration rates, by increasing soil porosity (AACED 2002; City of Portland 2002). The soil is amended by spreading a layer of compost on the surface and tilling both the soil and compost to a total depth of 12 inches. The general soil to compost ratio rule is 2:1 by unit volume (ODEQ 2001).

Key Considerations

Applicability

Both on-line and off-line bioretention can be utilized in new developments or be retrofitted into developed areas. However, there is much more latitude to incorporate bioretention practices in new developments because there are fewer constraints regarding siting and sizing. In fact, good planning and design may result in an integrated site-wide bioretention system that decreases both initial project costs and long-term maintenance expenses. Bioretention practices are applicable in heavily urbanized areas such as commercial, residential, and industrial developments. For example, bioretention can be used as a storm water management technique in median strips, parking lots with or without curbs, traffic islands, sidewalks, and other impervious areas (EPA 1999).

The effectiveness of a bioretention system is a function of its infiltration and treatment ability and so the system must be sized to match the expected runoff. Miscalculating the capacity limits in the system design can lead to erosion and stabilization issues, particularly for on-line systems. The following criteria can be used to determine the suitability of bioretention:

- Drainage area - 0.25 to one acre per bioretention system (multiple systems may be required for larger areas);
- Space required - Approximately five percent of the impervious area that will contribute runoff; and
- Minimum depth to water table - No less than two feet between ground surface and seasonally high water table.

Typical maintenance activities for any bioretention system are re-mulching void areas; treating, removing, and replacing dead or diseased vegetation; watering plants until they are established; soil inspection and repair; and litter and debris removal.

Advantages

Bioretention reduces storm water runoff and can consequently help reduce the size and cost of storm water control facilities, and the volume and frequency of CSOs. Bioretention can be an effective LID retrofit, especially in urban areas with minimal open space and extensive impervious area. Bioretention systems have also shown promise in the removal of pollutants via physical and biological processes of adsorption, filtration, plant uptake, microbial activity, decomposition, sedimentation, and volatilization (EPA 1999). Types of pollutants removed include metals, phosphorus, hydrocarbons, suspended solids, nitrogen, organic matter, and oils (EPA 1999). Also, bioretention systems can reduce on-site flooding, improve groundwater recharge, help maintain stream baseflows, provide habitat, and have aesthetic value. On-line systems are most cost-effective when incorporated into the initial design or into the repair/reconstruction process of an area (i.e. parking lots). Off-line bioretention systems are cost-effective as retrofits in urban areas as they require little space and can be incorporated into existing urban landscapes.

Disadvantages

Functional problems of bioretention systems may arise such as clogging of the ponding area with sediment over time. Thus, pretreatment and regular maintenance are necessary components to the overall implementation. In many cases, maintenance tasks can be completed by a landscaping contractor. Systems with compost amendments require regular replacement of the compost. Additional soil amendments, such as lime or gypsum, may also be necessary to replenish nutritional deficiencies and correct unsuitable alkalinity levels (Chollak and Rosenfeld 1998).

Cost

The cost of a residential off-line bioretention system averages about \$3-\$4 per square foot, depending on the soil conditions and the density and types of plants used, whereas the cost of commercial, industrial, and institutional applications of bioretention systems range between \$10-\$40 per square foot, based on the need for control structures, curbing, storm drains, and underdrains (LID 2003). Landscaping costs required regardless of bioretention installation should be subtracted when determining the net cost of the bioretention system. As the size of bioretention systems can vary, so can the associated installation costs. In addition, in residential areas, storm water management controls become a part of each property owner's landscape, reducing the public burden to maintain large centralized facilities (LID 2003).

Retrofitting a site may entail additional costs (EPA 1999). The higher cost of a retrofit is attributed to the demolition of existing concrete, asphalt, and other structures and replacing fill material with planting soil. The costs of soil amendments are site specific as well. For a shallow (up to an 8-inch depth) compost amendment that incorporates in-site soil in a small area, the estimated cost is \$1-\$3 per square foot (LID 2002).

Bioretention has the potential for cost savings compared to other types of storm water drainage techniques, such as curbs and gutters. The operation and maintenance costs for a bioretention facility are comparable to that of typical landscaping. Additional costs beyond the normal landscaping fees will be site specific, but can include soil testing, planting soil installation, and soil amendment components.

Implementation Examples

MAPLEWOOD, MN

Responsible Agency: City of Maplewood

Rain Gardens in Residential Development

The City of Maplewood launched a storm water management project that implemented rain gardens instead of traditional curb and gutter systems in three neighborhoods. This decision was prompted by a combination of positive results of previously completed rain garden pilot projects, the need for road upgrades, and existing drainage problems in several neighborhoods. Considering bioretention as an environmentally friendly and aesthetically pleasing alternative, the city decided to focus on demonstration, education, and outreach to convey the benefits of using rain gardens for runoff management. Each bioretention system incorporated rain gardens and grass swales to collect runoff from streets and yards with a holding capacity of 0.5 inch of rain (85 percent of the local rainfall occurs during storms totaling 0.5 inch or less) (NSN 2001). The utilization of rain gardens in the neighborhoods was on a voluntary basis. However, the city offered incentives providing homeowners with plants, landscape plans, educational materials, and demonstrations free of charge. The three standard garden sizes offered were 12 foot by 24 foot, 10 foot by 20 foot, and 8 foot by 16 foot. At least 130 rain gardens are expected to be installed by the end of 2003. Within the project neighborhoods, the city is installing rain garden systems at schools, nature centers, and neighborhood parks. The city is providing necessary regrading or curb work to achieve the proper slope for each system. Volunteers for disabled or elderly residents wishing to participate in the program are being provided as well. Whether the residents utilize the gardens or not, all residents must pay an annual assessment to cover the costs of the projects.

This bioretention project costs 75-85 percent of the cost of traditional curb and gutter systems (NSN 2001). Each garden costs \$600-\$700 including excavation, rock infiltration sump, scarifying of the soils, bedding material, shredded wood mulch, and vegetation. Costs were kept low by recycling and using street material in lieu of gravel, by obtaining the plants from a local correctional facility green house program, and by having residents be responsible for the planting. Otherwise, the cost of each garden was estimated to be between \$1,200-\$1,500. The potential long-term savings are more difficult to quantify, but include reduced demand on the city's downstream storm sewer infrastructure.



Photo: City of Maplewood



Photo: City of Maplewood

Contact: Chris Cavett, Assistant City Engineer, City of Maplewood

PRINCE GEORGE'S COUNTY, MD

Responsible Agency: Prince George's
Department of Environmental Resources

Residential Rain Garden Program

An 80-acre residential development site in Prince George's County, MD, consisting of 199 homes on 10,000 square foot lots was designed featuring bioretention rain gardens. One to two rain gardens were built on each lot in the development. Each garden is 300-400 square feet in size and consists of ornamental grasses, mulch, shrubs, and trees. The rain gardens were implemented as means of storm water attenuation. The gardens control storm water quantity and quality by collecting runoff from driveways and rooftops for infiltration into the ground. Each garden generally includes a mulch layer underlain by a sandy loam or loamy sand planting media with a minimum depth of two feet. A one-foot sand layer was placed below the planting media to help store the runoff at sites with low porosity subsurface soils. Grassy swales were used to connect the rain gardens to storm drain inlets and provided additional quantity and quality management compared to a traditional curb and gutter system. Water was allowed to pool to a depth of six inches in the rain garden after each rain event. The basins provided a maximum of 48-hour storage onsite.

Analysis of the project costs showed the rain gardens were a cost-effective storm water management strategy. Each garden cost approximately \$500, which consisted of \$150 for excavation and \$350 for vegetation. The total cost of the project was \$100,000 compared to the projected cost of \$400,000 for a pond system which was the other storm water management alternative considered for the development. In addition, this allowed the developer to recover six lots that otherwise would have been used for the pond system. The area's naturally sandy soil was suitable for the sand base required in the rain garden profile, which kept the costs of the gardens down. Homeowners are responsible for replacing dead vegetation, regulating soil pH, removing filter clogs and excess sedimentation, keeping the storm water intake open, and repairing erosion damage. The overall savings to the developer from the use of bioretention was over \$4,000 per lot.



Photo: Prince George's County DER



Photo: Prince George's County DER

Contact: Larry Coffman, Prince George's County Department of Environmental Resources

WASHINGTON, DC

Bioretention System Retrofits

Responsible Agency: U.S. Navy

The Navy demonstrated LID effectiveness and applicability by installing a number of storm water retrofits, including both on-line and off-line bioretention systems, throughout the Washington Navy Yard (Lehner *et al.* 1999). These retrofits complement the Navy's effort to update the 150-year old separate storm sewer system. Video investigation, cleaning, and system modernization were conducted prior to the installation of ten pilot projects demonstrating the use of LID techniques in urban areas. Currently, the projects are undergoing monitoring and evaluation of maintenance requirements and pollution control effectiveness. Engineers designed the bioretention retrofits to treat the first one-half inch of rain, at a minimum. The two main retrofits were at the Willard Park and Dental Clinic parking lots, and cover a total of three acres of impervious surface. The Willard Park parking area incorporated the on-line bioretention retrofits in the replacement and repair of the parking lot. Bioretention was utilized to temporarily store and slowly release storm water to reduce the peak discharge. In an effort to maximize parking area, the bioretention systems were installed as strips between parking rows. Each unit is designed to treat 0.5 acre of impervious surface.

The Dental Clinic project is an example of implementing a combination of LID practices as part of a major reconstruction of the parking lot. Bioretention islands, sand filter gutter strips, and permeable pavers were installed between parking rows. Also, a tree box was installed within the property and soil amendments were made in some open space areas to increase infiltration capabilities of the soil.

Contact: Camille Destafney, Naval District Washington

References

Anne Arundel County Environmental Demonstration (AACED). "Revitalizing Compacted Soils." Retrieved November 11, 2002.
<http://www.srlt.org/compactsoils.shtml>

Chollak, Tracy and Paul Rosenfeld. 1998. *Guidelines for Landscaping with Compost-Amended Soils*. Prepared for City of Redmond Public Works.

City of Portland. 2002. *Storm Water Management Manual*. Environmental Services City of Portland Clean Water Works. Portland: City of Portland.

Coffman, Larry. Interview by Limno-Tech, Inc., 2002.

EPA. 1999. *Storm Water Technology Fact Sheet: Bioretention*. EPA 832-F-99-012.

Lehner, Peter, George Aponte Clark, Diane Cameron, Andrew Frank. 1999. *Storm water Strategies: Community Responses to Runoff Pollution*. New York: Natural Resources Defense Council.

Low Impact Development Center (LID) "Bioretention Cell Costs" Retrieved April 30, 2003.
http://www.lid-stormwater.net/bioretention/bio_costs.htm

Low Impact Development Center (LID) "Soil Amendment Costs." Retrieved November 21, 2002.
http://www.lid-stormwater.net/soilamend/soilamend_costs.htm

Nonpoint Source News-Notes. "Landscaped Rain Gardens Offer Stormwater Control." In *Notes on Watershed Management*. No. 66. October 2001. Retrieved November 14, 2002.
<http://notes.tetrattech-ffx.com/newsnotes.nsf>

Oregon Department of Environmental Quality (ODEQ). 2001. *Restoring Soil Health To Urbanized Lands: The Crucial Link between Waste Prevention, Land Use, Construction, Stormwater Management and Salmon Habitat Restoration*. Portland: Oregon Department of Environmental Quality.

Prince George's County Department of Environmental Resource, Programs and Planning Division (PGC) 2002. *The Bioretention Manual*. Prince George's County, MD: Department of Environmental Resource, Programs and Planning Division.

Inclusion of this technology description in this Report to Congress does not imply endorsement of this technology by EPA and does not suggest that this technology is appropriate in all situations. Use of this technology does not guarantee regulatory compliance. The technology description is solely informational in intent.



Water Conservation

Overview

Water conservation is the careful and efficient use of water in a manner that extends water supplies, conserves energy, and reduces water and wastewater treatment costs. As such, it is considered to be a low impact development (LID) control. With regard to CSO and SSO control, the reduced use of water through water conservation can decrease the total volume of dry weather sanitary sewage flowing through a sewer collection system. This produces an increase in conveyance and treatment capacity which then prevents some sewage from being discharged during periods when runoff, infiltration, and blockage exacerbate capacity constraints within wastewater collection systems.

Water conservation can be an important component of a program to control sewer overflows. It is not often a solution on its own, but can be effective when implemented in combination with other control methods.

There is a broad group of indoor and outdoor practices that reduces water consumption. Several of the important water conservation practices to reduce CSOs and SSOs are described below.

Water Efficient Fixtures and Appliances

Low-flow fixtures include low-flow toilets and urinals, showerheads, and faucets. Aerators, which break the flowing water into fine droplets by incorporating air without affecting wetting effectiveness, can be attached to showerheads and faucets to reduce water use. Self-closing and sensed faucets with automated water flow are available for commercial facilities (PNNL 2001). Installation of pressure-reducing valves can lower water consumption by reducing water flow and the likelihood of leaking pipes and faucets. Water efficient clothes and dish washers are also available. For example, high performance clothes washers can reduce water use from 35-55 to 18-25 gallons per load (PNNL 2001).

Water Recycling

Water recycling is the reuse of water for beneficial purposes (EPA 1998). Greywater, which is wastewater from sinks, kitchens, tubs, clothes and dish washers, can be reused for home gardening, lawn maintenance, cooling tower or boiler makeup water, landscaping, toilets, and exterior washing. More elaborate treated effluent recycling measures can also be implemented for residential, agricultural, and industrial uses.

Waterless Technology

Some available technologies eliminate the need for water for operation. Composting toilets treat domestic sewage (also food scraps, paper, lawn clippings, and grease) by composting and dehydration. This technology does not require hook-up to sewage or septic systems, and the end-product can be used as fertilizer. Waterless urinals use a liquid with a lower specific gravity than urine, such as barrier oil or other sealant liquid, that allows waste to pass through while an airlock cartridge in the base of the urine bowl prevents any malodor (GBS 2002).

Rain Harvesting

Rain harvesting is an interception practice that collects and stores roof runoff before it enters the sewer or storm water system. Typical components of a rain collecting system are a gutter or down spout; holding vessels (i.e., cisterns, rain barrels, or tanks); and a filter or screen (TWDB *et al.* 1997). Most often, harvested water is for home gardening or lawn care. More complex systems designed to collect water for in-home use require a water treatment system to settle, filter, and disinfect the water, as well as a gravity or pump system to transport the treated water (TWDB *et al.* 1997).

Key Considerations

Applicability

Water conservation makes sense for many reasons. One important reason is the contribution that water conservation can make to reducing the volume of CSO and SSO discharges. A few considerations regarding specific practices are discussed in the paragraphs below.

Water Efficient Fixtures and Appliances

Water efficient fixtures can be installed or retrofitted in residential, commercial, institutional, and recreational facilities. Buildings undergoing construction or remodeling have great potential for incorporating water-wise technologies, and most of these technologies are readily available in the U.S. Water efficient fixtures can be a practical and economical alternative for homes.

Toilets, showers, and faucets account for approximately 60% of all indoor residential water use (EPA 1995). In most instances, money saved from reduced water and sewer bills can offset installation costs over time, and the reduction of wastewater places less stress on sewer systems. Toilets in particular are one of the greatest residential water uses and have considerable water saving potential. By installing low-flow toilets, toilet water use can be reduced from more than 3.5 gallons to 1.6 or less gallons per flush (gpf). Low-flow toilets function similar to conventional toilets, and are therefore easy to substitute. Since low-flow toilets were first introduced in the 1980s, manufacturers have made significant improvements in toilet design, thus reducing the need to double flush, which was a source of customer dissatisfaction and a reduction in efficiency among earlier models (EPA 2002). In fact, current federal law requires that residential toilets manufactured after January 1, 1994, must use no more than 1.6 gpf; and that commercial toilets manufactured after January 1, 1997, must use no more than 1.6 gpf; and urinals must use no more than 1 gpf (FEMP 2002). Similar to low-flow toilets, low-flow showerheads conserve water by reducing water use from 4.5 to 2.5 gallons per minute (gpm) (EPA 1995). These showerheads are simple to install and relatively inexpensive, but flow can be reduced over time by scale buildup (EPA 1995). Various cities throughout the U.S. have established incentive programs, such as rebates, promoting the use of low-flow or water efficient technologies.

Water Recycling and Reuse

Water recycling and reuse have the potential to satisfy many household water needs and have numerous

potential applications. In general, water recycling provides a locally controlled water supply that can be developed in both residential and non-residential facilities. Benefits to users of greywater systems are reduced water and sewer bills due to lowered wastewater discharge and water usage. Reuse of greywater also can improve local water quality by reducing greywater pollution (i.e. organics) that may otherwise be discharged into local rivers and streams during sewer overflow events. The disadvantages are mainly in the costs of equipment and labor to install the system. For more complex systems, the economic payback period may extend beyond the life of the system. Periodic maintenance is required, and contaminants such as paint, bleach, and dye must not enter the system. Some local regulations may not be adapted for such systems. Sanitary engineers, inspectors, and boards of health may lack familiarity with such systems as well.

Cooling tower water recycling is most useful for commercial, institutional, and industrial facilities such as hospitals, factories, nuclear power plants, apartment buildings, and chemical plants. The recycling of cooling water reduces wastewater discharge, lowers water and sewer bills, and reduces the discharge of chemicals to wastewater collection systems. The operation of recirculating cooling towers in industrial buildings, however, can reduce production efficiency as the system pumps consume power. Regular maintenance is required to ensure efficient application of cooling tower technologies.

Waterless Technology

Technologies that eliminate the need for water all together are the ultimate water conservation tool. Composting toilets are particularly suitable for use in recreational facilities such as parks, although there are residential and commercial applications as well. The advantages include eliminating the need for potable water to flush the toilet and reduced sewer bills. Composting toilets, however, are not ideal in cold climates, can require some energy (i.e., ventilation and heating) to optimize composting, and need regular maintenance. Waterless urinals are another product line that conserve water. While suitable for commercial and other public facilities, their use can be limited because they are not always socially acceptable, and they require regular maintenance.

Institutions such as hospitals can benefit from ozonated laundering which provides disinfection but does not require detergent or rinsing. Ozone generation is power-intensive, requiring significant amounts

of electricity that may reduce its cost-effectiveness in certain applications. Also, ozone is reactive and corrosive and thus requires resistant material such as stainless steel (NSFC 1998).

Rain Harvesting

Important considerations for rain harvesting include age and type of roof, amount of canopy overhang, and availability of space to position rain barrels or other storage units. Rain harvesting costs vary depending on the complexity of the system. Rainwater yield varies with the size and texture of the catchment area. Systems can be custom designed and built or purchased as a package. Minimal costs are associated with simple systems consisting of a gutter and collection barrel serving a home. Applications of rain harvesting can be limited to certain geographical regions, as some western states have water laws that may impose restrictions on the practice of rain harvesting.

Cost

Important considerations in evaluating the effectiveness of water conservation technologies include determining if the water conservation savings offset the costs of implementing the technology; assessing the feasibility of the technology given local restrictions and building codes; size and complexity of installation; location (residential

vs. non-residential); and local water and sewer rates. Cost-effectiveness of specific technologies varies greatly depending on water use and geography. It is also important to consider the water conservation potential of combining the various technologies.

Among water efficient fixtures and appliances, low-flow showerheads and faucet aerators are almost always cost-effective due to the relative low cost and minimal labor required. Low-flow toilets also have widespread application, particularly in commercial and institutional settings, because the economic offset period can be relatively short. The cost-effectiveness of other technologies mentioned in this fact sheet, however, will be based on site-specific considerations. Major factors affecting the cost-effectiveness of water efficient landscaping include landscape area, type of vegetation, geography, and climate. The cost-effectiveness of rain harvesting is controlled by the amount of rainfall and storage capacity. For greywater systems, the cost-effectiveness will vary based on flow rate, water quality, temperature, local building regulations (TBS 2002), and size of the reuse system. Due to the various types of applications for cooling towers, cost-effectiveness calculations are system specific. The cost-effectiveness of waterless technology will be controlled by the availability of connections to water and sewer lines. Table 1 provides general estimates of the costs and benefits of each water conservation technology.

Table 1. Water conservation technology cost and performance¹.

Category	Technology	% Water Conserved ²	Approximate Cost (\$)	Life Span (yrs.)
Water Efficient Fixtures and Appliances	Ultra low-flow toilet	54-68%	\$200-300	15-25
	Low-flow showerhead	45%	\$23	2-10
	Faucet aerator	40%	\$13	1-3
	Clothes washer	49-55%	\$1000	12
Recycling/ Reuse	Residential greywater reuse	up to 54%	\$400-\$5000	Not Available
	Cooling tower	up to 90%	Not Available	Not Available
Waterless	Composting toilet	100%	\$1000-\$2000	Not Available
	Waterless urinal	100%	\$300-\$500	Not Available
Rain Harvesting	Rain barrels or cisterns	Varies	\$100-\$20,000	Not Available

¹These estimates are for illustrative purposes and may not be applicable to a given situation. Estimates are from various sources including PNNL 2001 and CUWCC 2002.

² Percentage of water saved when compared to conventional water use application (no conservation measures taken).

Implementation Examples

SIERRA VISTA, AZ

“Water Watch” Program

Responsible Agency: Sierra Vista Water Management Team

The City of Sierra Vista established a water management team in September 2000 to assess the public’s perception of local water issues, educate and involve the public on water management issues, provide incentive-based

conservation alternatives, identify and address new water conservation opportunities, and implement water conservation programs. The water conservation programs include a toilet rebate program to encourage residents to voluntarily install low-flow toilets, free in-home retrofits of high-use water fixtures, a leak detection program, an internal “Water Watch” program to monitor municipal water use, public education and surveying, and partnerships with the Chamber of Commerce to involve the business community. For the toilet rebate program, qualified participants received \$100 for each unit replaced with a limit of two units per household. Sierra Vista has approximately 13,400 homes built prior to 1987 that may have high-flow toilets and fixtures. Replacement of all high-flow fixtures could save the city up to 261 million gallons of water annually. The old high-flow fixtures collected by the city through this rebate program were crushed and used as road-base material for various city projects. For fiscal year 2002, 195 toilets were replaced through the rebate program saving two million gallons of water, while 110 homes were retrofitted with low-flow fixtures saving an additional 3.3 million gallons of water. The program provided homeowners the opportunity to have their high-flow fixtures modified with low-flow alternatives at no cost to the homeowner. Sierra Vista has also taken regulatory measures by adding the following code requirements:

- New commercial car washes must recycle 75% of their water
- Waterless urinals in all commercial facilities with urinals
- Turf limits for new golf courses and new developments
- Commercial landscapes must feature low water use plants from city-approved list
- New irrigation standards for steep slopes and medians
- Hot water recirculating pumps in new homes
- Independent water meters required for each multi-family unit

In addition, the “Water Watch” program involved internal monitoring and evaluation aimed at reducing water consumption in the city’s facilities. Monthly water invoices from the city’s use of water from its wells and from private water companies were checked for anomalies. Trained personnel also conducted inspections at virtually all of the city’s facilities, providing an inventory of water fixtures and identifying leaks and inefficiencies. The city was also involved in an internal retrofitting program where water fixtures were replaced with low-flow units. A study by the city showed the total acre-feet of water consumed between calendar year 2000 to 2001 decreased from 2.5 billion gallons to 2.3 billion gallons of water for Sierra Vista.

Contact: Patrick J. Bell, Environmental Services Manager, City of Sierra Vista

ALBUQUERQUE, NM

Water Recycling in Cooling System

Responsible Agency: U.S. Department of Energy

Sandia National Laboratory has established several water conservation programs within its facilities, one of which is located at the Compound Semiconductor Research Laboratory (CSRL). The CSRL replaced its cooling system used for its laser installations from a once-through water cooling system to a cooling loop cooling system. By reusing cooling water, CSRL is able to save five to ten million gallons of water per year based on normal usage. The water bill savings are estimated at \$10,000-\$30,000 per year. The project cost was \$200,000.

Contact: Darrell Rogers, Sandia National Laboratories

HOUSTON, TX

Responsible Agency: City of Houston and Houston Housing Authority Joint Water Conservation Project

Water Efficient Fixtures in Housing Project

Low-flow plumbing fixtures were installed in a 60-unit low income multifamily housing complex in Houston, owned and managed by the Housing Authority of the City of Houston (HACH). The average number of occupants per unit was 4.4. Devices installed in each unit included low-flow toilets (1.6 gpf), low-flow aerators on faucets (2.2 gpm), and new water meters for each unit. Faucet leaks were repaired, and tenants were educated on conservation techniques. The project resulted in a reduction in average monthly water consumption for the complex from 1.3 million gallons pre-installation to 367,000 gallons post-installation. Average monthly savings on water bills for the complex was \$6,834. Due to the success of the project, HACH (funded by HUD) has retrofitted four of its other low income housing developments.

Water use and bill comparison before and after project.

	Before	After
Water Use Comparison		
Avg Monthly Consumption	1,300,000 gals.	376,000 gals.
Avg Monthly Consumption/Unit	21,666 gals.	6,116 gals.
Avg Monthly Consumption/Person	4,924 gals.	1,390 gals.
Avg Consumption/Person/Day	146 gals.	46 gals.
Water Bill Comparison		
Avg Monthly Bill	\$8,644.00	\$1,810.00
Avg Monthly Bill/Unit	\$144.00	\$30.17

Contact: Pat Truesdale, City of Houston Public Works and Engineers Water Conservation Branch

HILLSBOROUGH COUNTY, FL

Responsible Agency: Hillsborough County Water Department

Water Conservation Program

Due to rapid urban growth on Florida's west coast, Hillsborough County's water resources were experiencing significant stress. To address this problem, the county established a comprehensive water conservation program. The program is composed of public education and regulatory, operational, and financial incentive/disincentive components. Examples of some of the program's projects include full-time enforcement of water use restrictions, rebates for water efficient devices, and educating communities on water conservation. The program has effectively reduced the per capita water consumption in the county from 146 to 105 gallons per person per day; well below the regional requirement of 130 gallons. The low-flow toilet rebate program that was started in 1994 replaced 75,200 fixtures, saving an estimated 1.7 MGD. The county also established a reclaimed water program where approximately 11 million gallons of reclaimed water are used by approximately 7,000 residential and commercial customers daily, and the numbers are growing. This program has helped reduce the need for groundwater withdrawals and wastewater discharges.

Contact: Norman Harcourt Davis IV, Water Conservation Manager, Hillsborough County Water Department

WASHINGTON, DC

Responsible Agency: DC Water and Sewer Authority (WASA)

In 2001, the DC Water and Sewer Authority undertook a study of the effectiveness of rain harvesting in controlling storm water runoff from rooftops within its combined sewer service area. Rooftops are a major type of impervious surface whose runoff can contribute to CSO events. Rain barrels were analyzed as a means for capturing storm water runoff from rooftops, thereby reducing flow in the combined sewer system. The 75-gallon rain barrels were installed at two types of homes (detached and rowhouse), each with distinct roof configurations, and were monitored over a nine-month period. For the study area, under a design rainfall of 0.19 inch, the study showed that approximately 27,521 gallons out of a total of 211,950 gallons of runoff generated would be controlled using rain barrels. Rain harvesting from roofs on rowhouses appeared to be more cost-effective than on detached homes. Calculations indicated that for a one million gallon reduction in storm water volume, rain barrels would need to be installed in 20 percent of the rowhouses at an estimated cost of \$1.7 million (MWCOG 2001).

Rain Harvesting Study



Photo: DC WASA

Contact: Phong Trieu, Peter Guillozet, John Galli, or Matt Smith, Metropolitan Washington Council of Governments

COLORADO SPRINGS, CO

Responsible Agency: U.S. Army



Photo: US Army

Water Reuse at Vehicle Wash

Fort Carson's Central Vehicle Wash Facility services approximately 4,000 military vehicles using recycled water and has been in operation for over 11 years. This facility is an example of a closed loop recycling water treatment system that consists of grit chambers, sand filters, oil skimmers, and aeration basins, and has a storage capacity of 9.6 million gallons. Grass carp were introduced in the aeration and stilling basins to control aquatic vegetation and to avoid use of algacides. On a given day, up to 491 vehicles can be washed, using 10 million gallons of water. As this treatment system is essentially self-sustaining, there is minimal impact on Fort Carson's sewage and industrial wastewater treatment systems. The yearly rainfall is usually sufficient to make-up for evaporation losses. Each year, the system conserves 150-200 million gallons of water. The facility was built at a cost of \$7 million.

Contact: Richard Pilatzke, Fort Carson

References

California Urban Water Conservation Council. "H₂Ouse." Retrieved October 16, 2002.
<http://www.h2ouse.net/action/index.cfm>

EPA Office of Water. "High Efficiency Toilets." Retrieved June 28, 2002.
<http://www.epa.gov/OW-OWM.html/water-efficiency/toilets.htm>

EPA Water Division Region 9. 1998. *Water Recycling and Reuse: The Environmental Benefits*. EPA 909-F-98-001.

EPA Office of Water. 1995. *Cleaner Water Through Conservation*. EPA 841-B-95-002.

Federal Energy Management Program. "Water-Conservation Best Management Practices." Retrieved October 10, 2002.
http://www.eren.doe.gov/femp/techassist/best_practices.html

Green Building Services. "Green Technology Brief: Water Conservation." Retrieved June 14, 2003.
<http://greenbuildingservices.com/images/PDF/WaterConWeb.pdf>

Metropolitan Washington Council of Governments (MWCOC). 2001. *Combined Sewer Overflow Rooftop Type Analysis and Rain Barrel Demonstration Project*. Prepared for The District of Columbia Water and Sewer Authority. Washington DC: Metropolitan Washington Council of Governments.

National Small Flows Clearinghouse (NSFC). 1998. *Environmental Technology Initiative Fact Sheet: Ozone Disinfection*. National Small Flows Clearinghouse Item #WWFSGN100. Morgantown, WV, West Virginia University.

Pacific Northwest National Laboratory (PNNL). 2001. *Market Assessment for Capturing Water Conservation Opportunities in the Federal Sector*. Prepared for the US Department of Energy Federal Energy Management Program. Richland, WA: Pacific Northwest National Laboratory.

Tool Base Services. "Water Conservation." Retrieved October 11, 2002.
<http://www.toolbase.org/secondaryT.asp?TrackID=&CategoryID=1002>

Texas Water Development Board (TWDB) and Center for Maximum Potential Building Services (CMPBS). 1997. *Texas Guide to Rainwater Harvesting*. Austin, TX: TWDB and CMPBS.

Inclusion of this technology description in this Report to Congress does not imply endorsement of this technology by EPA and does not suggest that this technology is appropriate in all situations. Use of this technology does not guarantee regulatory compliance. The technology description is solely informational in intent.

Appendix M

Financial Information

M.1 Cost Escalation Factors

M.2 Past Investments in Wastewater
Infrastructure

M.3 Projected Needs for CSO Control

M.1 Cost Escalation Factors

All cost information presented in this Report to Congress is in 2002 dollars unless otherwise noted. Capital costs were adjusted using the Chemical Engineering Plant Cost Index (CEPCI); O&M Costs were adjusted using the Gross Domestic Product Implicit Price Deflator (GDPIPD). A summary of these cost factors from 1970 to 2002 is provided in Table M.1.

Table M.1 Cost Escalation Factors

Year	Capital	O&M
1970	126	0.2849
1971	132.3	0.2992
1972	137.2	0.3132
1973	144.1	0.3271
1974	165.4	0.3504
1975	182.4	0.3867
1976	192.1	0.4140
1977	204.1	0.4451
1978	218.8	0.4756
1979	238.7	0.5142
1980	261.2	0.5599
1981	297	0.6142
1982	314	0.6572
1983	317	0.6861
1984	323	0.7114
1985	325	0.7349
1986	318	0.7526
1987	324	0.7733
1988	343	0.7986
1989	355	0.8293
1990	357.6	0.8605
1991	361.3	0.8940
1992	358.2	0.9174
1993	359.2	0.9393
1994	368.1	0.9596
1995	381.1	0.9804
1996	381.7	1.0000
1997	386.5	1.0195
1998	389.5	1.0339
1999	390.6	1.0477
2000	394.1	1.0679
2001	394.3	1.0940
2002	395.6	1.1080

M.2 Past Investments in Wastewater Infrastructure

The federal government has been investing in the nation's wastewater infrastructure since the late 19th century. With the passage of the Clean Water Act in 1972, federal investment markedly increased, peaking in 1977. As shown in Table M.2, between 1970 and 2000, the federal government invested more than \$122 billion in the nation's wastewater infrastructure.

Table M.2 Federal Funding for Wastewater Infrastructure, 1970 - 2000
(billions of dollars)

Year	Construction Grant ^a	CWSRF ^b	EPA Line Item	Unadjusted Total	Total (2000 Dollars)
1970	< \$0.1	0	0	< \$0.01	< \$0.1
1971	< \$0.1	0	0	< \$0.01	< \$0.1
1972	\$0.1	0	0	\$0.1	\$0.4
1973	\$3.0	0	0	\$3.0	\$8.4
1974	\$2.5	0	0	\$2.5	\$6.0
1975	\$4.3	0	0	\$4.3	\$9.4
1976	\$4.6	0	0	\$4.6	\$9.5
1977	\$7.3	0	0	\$7.3	\$14.1
1978	\$2.8	0	0	\$2.8	\$5.1
1979	\$5.1	0	0	\$5.1	\$8.5
1980	\$3.8	0	0	\$3.8	\$5.8
1981	\$3.6	0	0	\$3.6	\$4.8
1982	\$2.3	0	0	\$2.3	\$2.8
1983	\$4.0	0	0	\$4.0	\$5.0
1984	\$4.6	0	0	\$4.6	\$5.6
1985	\$2.1	0	0	\$2.1	\$2.6
1986	\$2.3	0	0	\$2.3	\$2.9
1987	\$2.4	0	0	\$2.4	\$3.0
1988	\$3.1	\$0.3	0	\$3.4	\$3.8
1989	\$1.3	\$1.2	0	\$2.5	\$2.7
1990	\$0.9	\$1.4	0	\$2.3	\$2.6
1991	\$0.3	\$2.0	0	\$2.3	\$2.5
1992	\$0.3	\$1.9	\$0.4	\$2.6	\$2.8
1993	\$0.1	\$1.9	\$0.4	\$2.4	\$2.7
1994	\$0.1	\$1.3	\$0.4	\$1.8	\$1.9
1995	< \$0.1	\$1.3	\$0.6	\$1.9	\$2.0
1996	0	\$1.7	\$0.1	\$1.8	\$1.9
1997	0	\$0.8	\$0.1	\$0.9	\$0.9
1998	0	\$1.2	\$0.2	\$1.4	\$1.4
1999	0	\$1.3	\$0.2	\$1.5	\$1.5
2000	0	\$1.4	\$0.2	\$1.6	\$1.6
Total	\$60.9	\$17.7	\$2.6	\$79.5	\$122.2

^a EPA 2000

^b EPA 2003

EPA estimates that current combined capital investment in wastewater infrastructure from federal, state, and local governments is just over \$13 billion annually (EPA 2002). Today, according to industry organizations, individual utilities can pay as much as 90 percent of capital expenses (AMSA and WEF 1999). As shown in Table M.3, capital expenditures by state and local governments have remained relatively constant since 1988; annual O&M expenditures have more than doubled.

Table M.3 State and Local Expenditures on Wastewater Infrastructure, 1970 - 2000
(billions of dollars)

Year	Capital ^{a,b}	Adjusted Capital (2002 Dollars)	O&M ^{a,b}	Adjusted O&M (2002 Dollars)	Total (2002 Dollars)
1970	\$1.4	\$4.4	\$0.4	\$1.6	\$6.0
1971	\$1.7	\$5.1	\$0.8	\$3.0	\$8.0
1972	\$2.2	\$6.3	\$1.0	\$3.5	\$9.9
1973	\$2.4	\$6.6	\$1.2	\$4.1	\$10.7
1974	\$2.6	\$6.2	\$1.4	\$4.4	\$10.6
1975	\$3.6	\$7.8	\$1.7	\$4.9	\$12.7
1976	\$4.0	\$8.2	\$2.0	\$5.4	\$13.6
1977	\$4.2	\$8.1	\$2.3	\$5.7	\$13.9
1978	\$4.4	\$8.0	\$2.8	\$6.5	\$14.5
1979	\$5.6	\$9.3	\$3.2	\$6.9	\$16.2
1980	\$6.3	\$9.5	\$3.6	\$7.1	\$16.7
1981	\$6.9	\$9.2	\$4.2	\$7.6	\$16.8
1982	\$5.9	\$7.4	\$4.9	\$8.3	\$15.7
1983	\$5.8	\$7.2	\$5.4	\$8.7	\$16.0
1984	\$5.7	\$7.0	\$5.8	\$9.0	\$16.0
1985	\$5.9	\$7.2	\$6.3	\$9.5	\$16.7
1986	\$6.5	\$8.1	\$6.8	\$10.0	\$18.1
1987	\$7.5	\$9.2	\$7.4	\$10.6	\$19.8
1988	\$8.3	\$9.6	\$8.0	\$11.1	\$20.7
1989	\$8.3	\$9.2	\$8.7	\$11.6	\$20.9
1990	\$8.4	\$9.3	\$10.0	\$12.9	\$22.2
1991	\$9.1	\$10.0	\$11.0	\$13.6	\$23.6
1992	\$8.9	\$9.8	\$11.4	\$13.8	\$23.6
1993	\$10.3	\$11.3	\$12.4	\$14.6	\$26.0
1994	\$8.0	\$8.6	\$13.6	\$15.7	\$24.3
1995	\$8.9	\$9.2	\$14.7	\$16.6	\$25.9
1996	\$9.3	\$9.6	\$15.3	\$17.0	\$26.6
1997	\$9.6	\$9.8	\$16.1	\$17.5	\$27.3
1998	\$9.1	\$9.2	\$16.6	\$17.8	\$27.0
1999	\$9.7	\$9.8	\$17.3	\$18.3	\$28.1
2000	\$10.1	\$10.1	\$18.0	\$18.7	\$28.8
Total	\$200.2	\$260.3	\$234.4	\$316.0	\$276.9

^a U.S. Census Bureau. 2003. State and Local Government Finances by Level of Government. Retrieved October 2003. <http://www.census.gov/govs/www/estimate.html>.

^b EPA. 2000. Office of Water and Office of Policy, Economics, and Innovation. "A Retrospective Assessment of the Costs of the Clean Water Act: 1972 to 1997. Final Report." Retrieved October 2, 2003. <http://www.epa.gov/ost/economics/costs.pdf>

Many municipalities have made significant investments in CSO control within their jurisdictions. As part of the data gathering for this report, EPA was able to document expenditures on CSO control in 48 communities. To date, these expenditures total more than \$6 billion, ranging from \$134,000 to \$2.2 billion per community. (Table M.4)

Table M.4 Community Expenditures on CSO Control

State	Community	Capital Expenditure (\$M) ^a	Annual O&M (\$M)	Sources
CA	San Francisco, CA	\$1,450.0	\$20.3	EPA 2001, EPA 2003
DC	Washington, D.C.	\$35.0 ^b	\$13.7	EPA 2001
GA	Atlanta, GA	\$759.0		EPA 2001
GA	Columbus, GA	\$95.0	\$1.0	EPA 2001, AMSA 2003
IA	Burlington, IA	\$2.9		EPA 2001
IA	Washington, IA	\$0.6		CSO Municipal Interview
IL	Alton, IL	\$4.0		CSO Municipal Interview
IL	Chicago, IL	\$2,200.0	\$8.2	EPA 2001, EPA2003
IL	City of Batavia, IL	\$10.9		CSO Municipal Interview
IL	Decatur, IL	\$14.6		CSO Municipal Interview
IL	Galesburg, IL	\$9.7		CSO Municipal Interview
IL	Havana, IL	\$0.6		CSO Municipal Interview
IL	Lincoln, IL	\$3.1		CSO Municipal Interview
IN	Goshen, IN	\$12.3		CSO Municipal Interview
IN	Hammond, IN	\$13.7		CSO Municipal Interview
IN	Muncie, IN	\$20.5		EPA 2001
KY	Louisville, KY	\$25.0		EPA 2001
MA	Agawam, MA	\$5.9		CSO Municipal Interview
MA	Fitchburg, MA	\$0.1		CSO Municipal Interview
MA	MWRA, Boston, MA	\$110.0	\$2.0	EPA 2001, EPA 2003
MA	South Hadley, MA	\$2.5		CSO Municipal Interview
ME	Biddeford, ME	\$24.5		CSO Municipal Interview
ME	Hamden, ME	\$2.0		CSO Municipal Interview
ME	South Portland, ME	\$9.0	\$0.4	EPA 2001
MI	Armada, MI	\$1.3		CSO Municipal Interview
MI	Rouge River, MI	\$350.0	\$5.1	EPA 2001
MI	Saginaw, MI	\$105.2		EPA 2001, EPA 2003
MI	East Lansing, MI	\$20.0		EPA 2003, CSO Municipal Interview
MI	Scottville, MI	\$0.3		CSO Municipal Interview

Table M.4 continued

State	Community	Capital Expenditure (\$M) ^a	Annual O&M (\$M)	Sources
MO	Cape Girardeau, MO	\$34.5		CSO Municipal Interview
NJ	East Newark, NJ	\$0.4		CSO Municipal Interview
NJ	North Bergen, NJ	\$3.9		EPA 2001
NJ	Perth Amboy, NJ	\$6.0		EPA 2003, CSO Municipal Interview
NY	Salamanca, NY	\$1.0		CSO Municipal Interview
OH	Fremont, OH	\$15.9		CSO Municipal Interview
OH	Perrysburg, OH	\$7.6		EPA 2003, CSO Municipal Interview
OR	Portland, OR	\$76.0 ^b		EPA 2001
PA	Altoona, PA	\$13.5		CSO Municipal Interview
PA	Freeland, PA	\$3.0		CSO Municipal Interview
PA	Wyoming Valley, PA	\$12.0		CSO Municipal Interview
VA	Richmond, VA	\$221.0	\$6.8	EPA 2001
VT	Randolph, VT	\$2.9		EPA 2001
VT	Richford, VT	\$3.2		CSO Municipal Interview
VT	Windsor, VT	\$1.6		CSO Municipal Interview
WA	Bellingham, WA	\$17.0		CSO Municipal Interview
WA	Bremerton, WA	\$17.0	\$4.6 to \$6.1	EPA 2001
WA	King County, WA	\$266.0		CSO Municipal Interview
WA	Spokane, WA	\$50.0 ^b		EPA 2003

^a Capital Expenditure reflects the total amount (in unadjusted dollars) spent by the community on CSO control.
^b Includes updated information from the community's LTCP or other documents.

M.3 Projected Needs for CSO Control

Community-specific information on projected CSO needs was available from several sources including:

- *Report to Congress - Implementation and Enforcement of the CSO Control Policy*
- *2000 Clean Watersheds Needs Survey Report to Congress*

Together, these sources provide information on projected capital needs for CSO control in 71 communities, less than 10 percent of the CSO universe. The individual community needs, presented in Figures M.1, M.2, and M.3, total more than \$22 billion.

Figure M.1 Communities with Projected Capital Needs for CSO Control Exceeding \$100 million

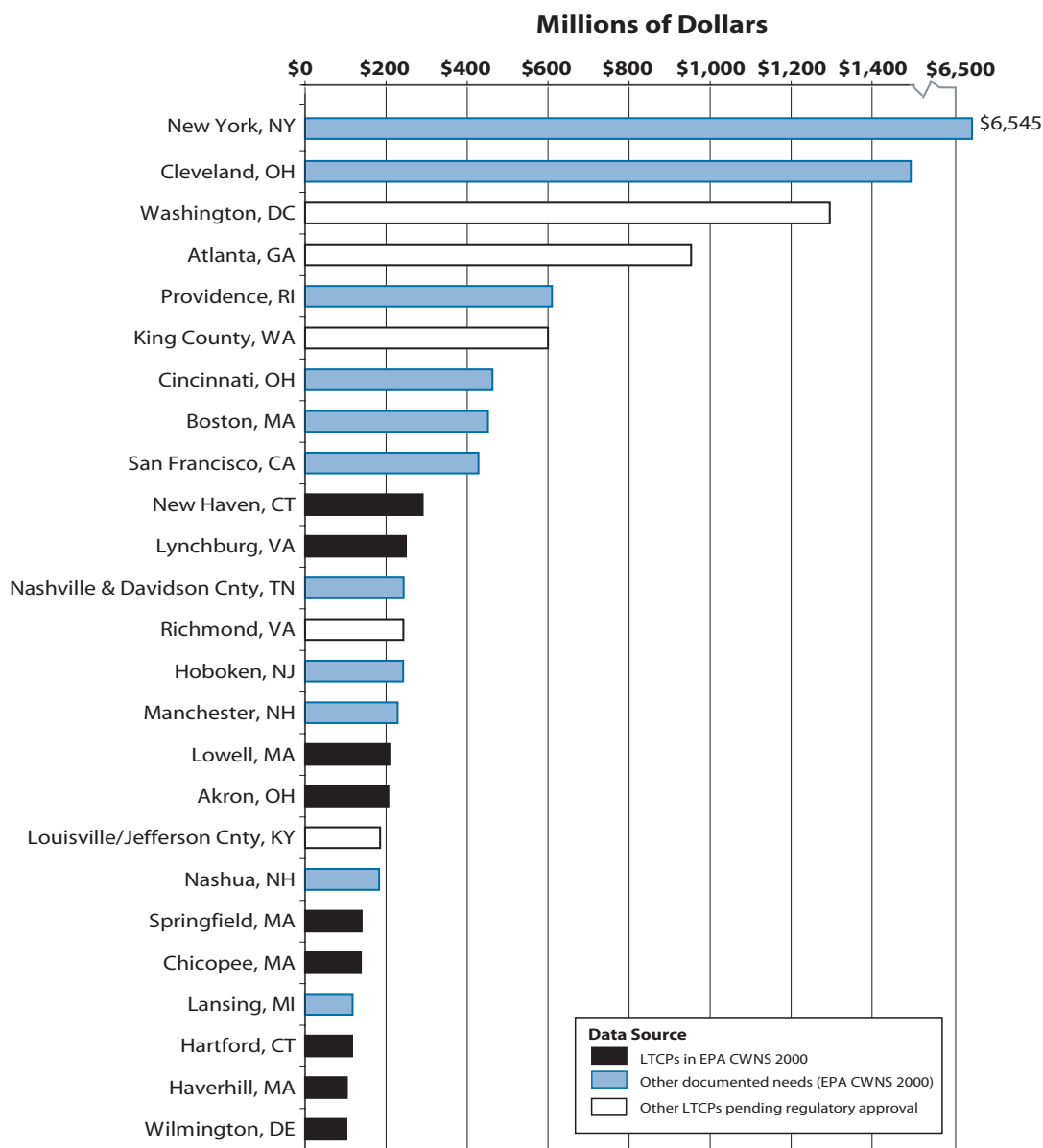

Figure M.2 Communities with Projected Capital Needs for CSO Control Between \$10 and \$100 million

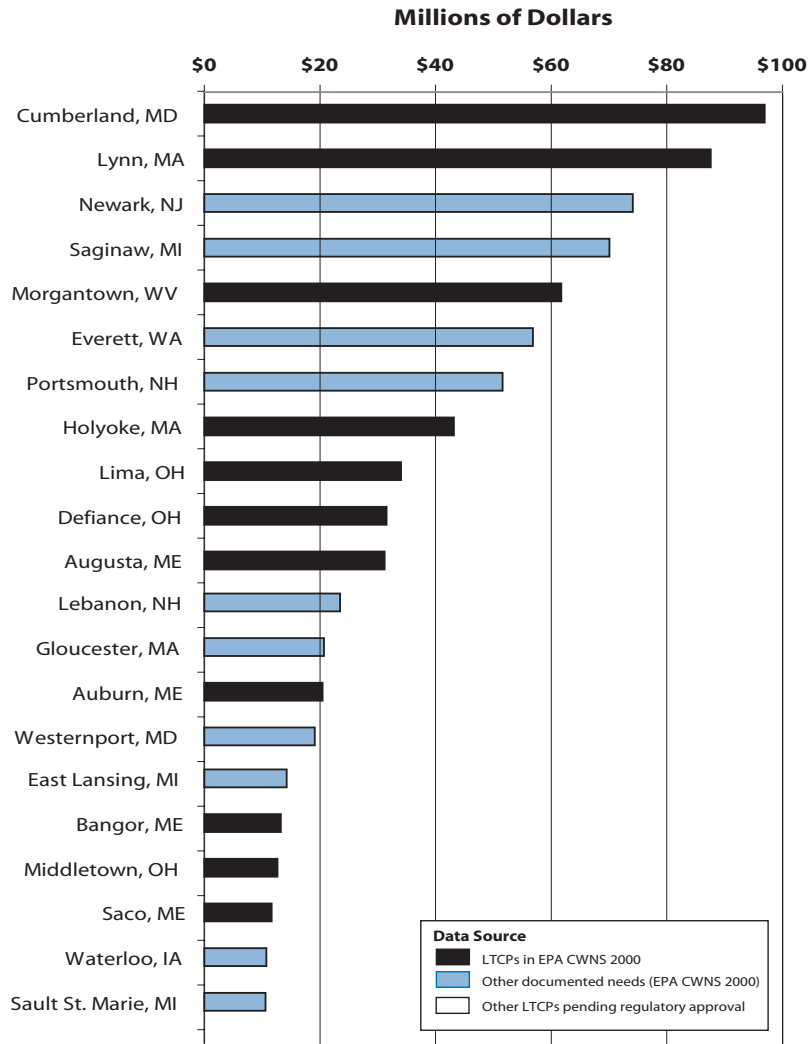
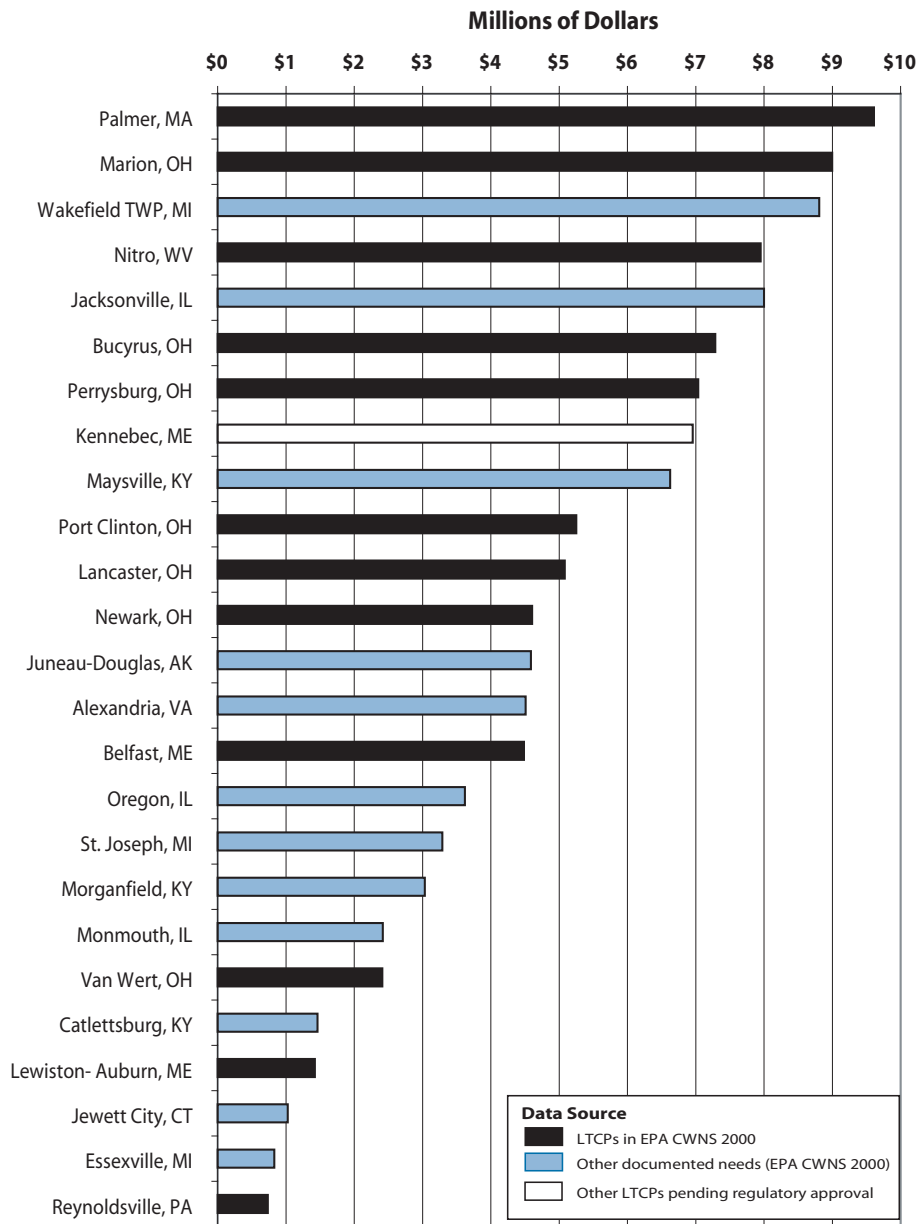

Figure M.3 Communities With Projected Capital Needs for CSO Control Ranging from \$735,000 to 10 million



References

Association of Metropolitan Sewerage Agencies (AMSA) and Water Environment Federation (WEF). 1999. "The Cost of Clean." Retrieved March 1999.

<http://www.amsa-cleanwater.org/pubs/cost/coc.pdf>.

EPA. 2000. Office of Water. *Progress in Water Quality: An Evaluation of the National Investment in Municipal Wastewater Treatment*. EPA 832-R-00-008.

EPA. 2001. Office of Water. Report to Congress on Implementation and Enforcement of the Combined Sewer Overflow Control Policy. EPA 833-R-01-003.

http://cfpub2.epa.gov/npdes/cso/cpolicy_report.cfm.

EPA. 2002. Office of Water. *The Clean Water and Drinking Water Infrastructure Gap Analysis*. EPA 816-R-02-020.

EPA. 2003. Office of Water. *Clean Watersheds Needs Survey 2000 Report to Congress*. EPA 832-R-03-001.